



MALOPRODAJNI

CENIK

2024

avgust

Cenjene kupce prosimo,
da zaradi pogostih sprememb cen
le-te preverijo neposredno
na navedenih telefonskih številkah.

Za artikle,
označene z *Odprodaja,
velja netto cena
brez dodatnega popusta.

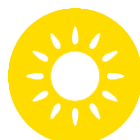

PILREMAG d.o.o.

www.pilremag.si

komerziala@pilremag.si

Brezje pri Grosupljem 34

tel. komerciala: + 386 1 78 63 983

1290 Grosuplje

tel. trgovina: + 386 (0) 59 11 2000

OGREVANJE	Blagovna znamka	Cena velja od:	Stran
KOTLI NA LESNE PELETE	TERMOMONT	1.03.2024	5
KOTLI NA PELETE	GALMET	1.11.2022	6
KOTLI NA TRDA GORIVA	MEGAL	25.4.2024	7
KOTLI NA TRDA GORIVA	MODRATHERM	1.12.2021	8
PELETNI GORILNIKI	PELLTECH	1.10.2022	9
KAMINI	HAAS & SOHN	10.6.2023	10
OLJNI KOTLI	DOMUSA	1.7.2021	12
DIMNIKI IZ NERJAVEČE PLOČEVINE ENOSLOJNI	JEREMIAS	24.4.2023	14
DIMNIKI IZ NERJAVEČE PLOČEVINE TROSLOJNI	JEREMIAS	24.4.2023	19
DIMNIKI IZ NERJAVEČE PLOČEVINE TROSLOJNI DW-BLACK	JEREMIAS	1.6.2024	NOVO 22
DIMNIKI IZ PVC ZA PLINSKE KONDENZACIJSKE KOTLE	JEREMIAS	24.4.2023	25
DIMNIKI KOAKSIALNI ZA PLINSKE KONDENZACIJSKE KOTLE	JEREMIAS	24.4.2023	27
DIMNIKI IZ ČRNE PLOČEVINE	JEREMIAS	20.10.2022	28
DIMNIKI IZ ČRNE PLOČEVINE ZA PELETNE KAMINE	JEREMIAS	24.4.2023	29
VENTILATORJI DIMNIH PLINOV	PELLTECH	1.1.2021	30
ČIŠČENJE KOTLOV, KAMINOV IN DIMNIKOV	UAB HANSA	1.11.2022	31
ELEKTRIČNI KOTLI	ECOTHERMAL	1.6.2023	32
TOPLOTNE ČRPALKE ZA OGREVANJE	GALMET	1.11.2022	33
TOPLOTNE ČRPALKE ZA OGREVANJE	MIDEA	10.11.2022	35
TOPLOTNE ČRPALKE ZA OGREVANJE	HOT-JET	1.4.2023	37
ELEKTRIČNI BOJLERJI	METALAC	1. 8. 2024	NOVO 43
KOMBINIRANI BOJLERJI	GALMET	1.4.2023	45
BOJLERJI	GALMET	4.9.2023	46
BOJLERJI ZA TOPLOTNO ČRPALKO	GALMET	4.9.2023	47
GRELCI, PRIROBNICE, TULKE ZA ZALOGOVNIKE	VOLUX, GALMET	4.9.2023	48
MALI ZALOGOVNIKI ZA TOPLOTNE ČRPALKE	GALMET, GOLD LEON	4.9.2023	49
ZALOGOVNIKI ZA OGREVANJE	SUNSYSTEM	1.1.2024	50
ZALOGOVNIKI ZA OGREVANJE	GALMET	4.9.2023	51
ZALOGOVNIKI Z BOJLERJEM	GALMET	4.9.2023	52
ZALOGOVNIKI ZA OGREVANJE + SANITARNO VODO INOX	GALMET	4.9.2023	53
RAZTEZNE POSODE	REFLEX	1.8.2024	NOVO 54
OBTOČNE ČRPALKE	AVANSA	18.4.2023	58
KOTLOVSKA REGULACIJA	BRV	15.11.2021	59
KOTLOVSKA REGULACIJA	REGULUS	10.4.2024	60
REGULACIJA ZA OGREVANJE IN HLAJENJE	SALUS	1.1.2023	62
REGULACIJA ZA OGREVANJE IN HLAJENJE	ENGO	1.1.2023	69
SOBNI TERMOSTATI	FRONTIER	20.3.2023	71
SOBNI TERMOSTATI	ELEKTROBOCK	20.3.2023	71
SONČNI KOLEKTORJI	ENSOL	15.7.2023	72
FLEKSIBILNE CEVI ZA SONČNE KOLEKTORJE	ALVEOFLEX	24.4.2023	72
RADIATORJI RADIK KLASIK	KORADO	7.5.2024	73
RADIATORJI RADIK VK, VKU	KORADO	7.5.2024	75
RADIATORJI RADIK VKM8	KORADO	7.5.2024	77
RADIATORJI RADIK LINE VERTIKAL-M	KORADO	20.5.2024	79
RADIATORJI RADIK PLAN VERTIKAL-M	KORADO	20.5.2024	80
RADIATORJI KORATHERM HORIZONTAL	KORADO	1.6.2024	NOVO 81
RADIATORJI KORATHERM HORIZONTAL VKM	KORADO	1.6.2024	NOVO 83

vsebina

OGREVANJE	Blagovna znamka	Cena velja od:	Stran
RADIATORJI KORATHERM VERTIKAL	KORADO	1.6.2024 NOVO	84
RADIATORJI KORATHERM VERTIKAL M	KORADO	1.6.2024 NOVO	85
RADIATORJI KORATHERM REFLEX	KORADO	1.6.2024 NOVO	86
RADIATORJI KORALUX NEO	KORADO	11.1.2023	87
RADIATORJI KORALUX KOPALNIŠKI	KORADO	1.12.2022	88
RADIATORJI P.THERMAL KOPALNIŠKI	PUCIHAR	8.9.2022	90
OPREMA ZA RADIATORJE	KORADO	1.3.2023	91
OPREMA ZA RADIATORJE ELEKTRIČNI GRELCI	VOLUX	10.4.2024	91
RADIATORSKI VENTILI	J.SCHLOSSER ARMATUREN	1.1.2021	93
RAZDELILCI ZA TALNO OGREVANJE	ONDA	20.5.2023	94
RAZDELILNE OMARICE ZA TALNO OGREVANJE	ECOTERMAL	1.4.2024	95
TALNO OGREVANJE CEVI	ISOLTUBEX	20.5.2023	95
TOPLOVODNI KALORIFERJI	VTS EUROHEAT	1.12.2022	96
ZRAČNE ZAVESE	VTS EUROHEAT	1.12.2022	98
PREZRAČEVANJE IN HLAJENJE			
REKUPERACIJA	AERAULIQA	1.6.2023	101
PREZRAČEVALNI DIFUZORJI	ERGOVENT	1.1.2023	110
REKUPERACIJA	OVA	1.6.2023	111
REKUPERACIJA	AWENTA PRO	1.10.2023	112
VENTILATORJI	AIRFLOW	6.02.2024	114
VENTILATORJI	AERAULIQA	15.2.2023	115
VENTILATORJI	EUROPLAST	1.6.2024 NOVO	117
DISTRIBUCIJA ZRAKA	EUROPLAST	1.6.2024 NOVO	120
VGRADNA VRATCA	EUROPLAST	1.6.2024 NOVO	129
KLIMATSKE NAPRAVE	MIDEA	15.4.2024	130
ČISTILA ZA OGREVALNE IN HLADILNE SISTEME	CHQUIMICA	15.4.2024	131
CEVNE OBJEMKE, NOSILCI, VIJAKI	SOLIDA	22.5.2024 NOVO	132
VODOVOD IN KANALIZACIJA			
ALUMPLAST PERT-AL-PERT PRESS	ISOLTUBEX	1.12.2022	139
ALUMPLAST PERT-AL-PERT VIJAČNI	ISOLTUBEX	1.6.2022	142
VODOVODNE ALKATEN CEVI IN FITINGI PE	VALDOM	1.4.2024	143
VODOVODNE CEVI IN FITINGI PP-R	VALDOM	5.4.2024	145
FILTRI IN MEHČALCI VODE	ATLAS	1.11.2022	147
KANALIZACIJA	HULIOT	1.6.2023	149
KANALIZACIJA	PLASTBRNO	1.6.2023	152
PREZRAČEVALNI VENTILI ZA KANALIZACIJO	DURGO	1.4.2023	160
ODTOČNE CEVI IN MANŠETE	PLASTBRNO	1.6.2023	161
SIFONI	PLASTBRNO	1.4.2024	162
ODTOČNE TUŠ KANALETE	PLASTBRNO	1.4.2024	165
TUŠ KADI	RIHO	15.1.2024	170
TUŠ KABINE	RIHO	15.1.2024	171
KOPALNE KADI	RIHO	15.1.2024	172
SANITARNA OPREMA	KERAMIKA LESKOVAC	23.2.2023	173
ARMATURE	PAFFONI	1.4.2023	176
KOPALNIŠKI DODATKI	NIMCO	21.3.2023	179
KOPALNIŠKI DODATKI ZA STAROSTNIKE / INVALIDE	K-DESIGN	9.10.2023	182
ELEKTRIČNA IN IR GRELNA TELESA	EKODOM	23.3.2023	183

KOMPAKTNI KOTEL NA LESNE PELETE B-Smart 9 - 30kW (nastavljiv)



KOTEL Z ZADNJE STRANI

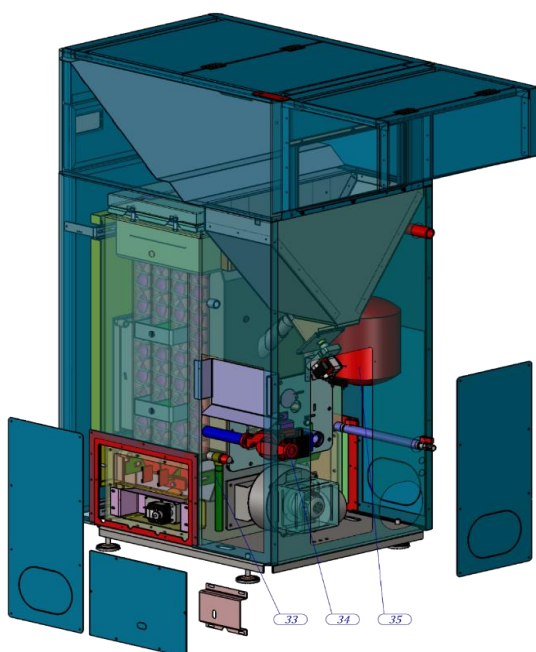

- 33) Varnostni ventil
- 34) Obtočna črpalka
- 35) Raztezna posoda 8L

Koda	Naziv	Moč (kW)	Cena
B-SMARTE 30	Kotel na pelete B-Smart	9 - 30	3.257,40

Kotli B-Smart za kurjenje na lesne pelete so zasnovani za postavitev v manjše prostore in ustrezajo manjšim prehodom. Gorilnik je premišljeno zasnovan (lastna izvorna rešitev zaščiten v Evropskem registru modelov EUIPO) in zagotavlja dodaten prihranek. B-Smart zalogovnik za pelete se montira na kotel na licu mesta. Vžig, zagon in izklop so popolnoma avtomatizirani. Izgorevanje nadzira algoritem v modulu, ki avtomatsko uravnava doziranje peletov glede na željeno in doseženo temperaturo. Izdelan je po standardu EN 303-5 in izpolnjuje stroga okoljska merila Evropske Direktive (Ecodesign criteria 2015:1189). Kotel lahko kurite le s kvalitetnimi peleti razreda EN 14961, A1 ali A2, premera 6mm ali 8mm. Obvezno je vgraditi termometer, manometer, izpustni termični ventil, termostatski mešalni ventil za varovanje povratka in odzračevalni lonček. Priporočljivo je vgraditi dodatno raztezno posodo.

Wi-fi regulacija omogoča servisno podporo in upravljanje kotla preko aplikacije.

Subvencija EKO sklada.

Tehnični podatki	
Tip kotla	Eco Boiler CG7*
Nazivna moč	30 kW
Moč	9-30 kW
Temperaturni razpon	60- 80 °C
Najmanjša temperature povratnega voda	50 °C
Poraba goriva pri najmanjši moči	min 1,8 kg/h
Poraba goriva pri največji moči	max 6 kg/h
Peleti - razred kvalitete	A1, A2 Ø6, Ø8
Teža kotla	245 kg
Najvišji delovni tlak	2,5 bar
Volumen zalogovnika pelet	150 l
Volumen podaljšanega zalogovnika pelet	230 l
Priključni vod / Povratni vod	1"
Polnjenje / praznjenje	1/2"
Odvod dimnih plinov premer	120 mm
Dovod zraka	50 mm
Izhodna temp. dimnih plinov	140 °C
Min. vlek dimnika	10 Pa
Volumen vode v kotlu	58 l
Napajanje	220 V 50 Hz
Poraba el. energije pri zagonu	400 W
Poraba el. energije pri delovanju	100 W
Razred učinkovitosti kotla	5
Razred emisij kotla	5

Emisije v ogrevalni sezoni	mg/m ³ _n (sur 10% O ₂)
CO	70
OGC	1
Dust	19.2
NOx	148
Sezonska učinkovitost	80%
Razred energetske učinkovitosti	A+

KURILNA NAPRAVA NA PELETE Z ROTACIJSKIM GORILNIKOM (samočistilni) GALMET



Koda	Naziv	*Odprodaja	Moč (kW)	Cena
07-105300*	GENESIS PLUS KPP 10	kotel na pelete	11	3.318,40
07-155300*	GENESIS PLUS KPP 15	kotel na pelete	15	3.403,80
07-205300*	GENESIS PLUS KPP 20	kotelč na pelet	20	3.702,70

IZKORISTEK DO 97%

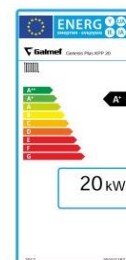
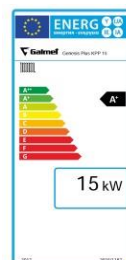
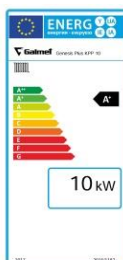

TEHNIČNI PODATKI	Enote	Genesis Plus KPP 10	Genesis Plus KPP 15	Genesis Plus KPP 20
Nazivna moč	kW	11	15	20
Območje moči	kW	3,4 + 10,9	4,5 + 15,2	5,6 + 19,4
Razred kotla (EN 303-5:2012)		5	5	5
Ogrevalna površina kotla	m ²	1,66	2,08	2,63
Vrsta goriva	Lesni peleti, velikost zrn 6+8 mm			
Razred goriva	A1 EN 14961-2			
Velikost posode za pelete	l		180	180
Pretok goriva (pri max. obremenitvi)	kg/h	2,36	3,5	4,19
Čas ogrevanja ob enem polnjenju pri naz. moči	h	76,27	51,42	42,95
Izkoristek	%	96,56	96,75	97,01
Zahtevani vlek dimnika	mBar	0,16	0,2	0,24
Minimalna višina dimnika	m	6	6	6
Minimalni prerez dimnika	mm	fi 160	fi 160	fi 160
Temperatura dimnih plinov pri naz. moči	°C	75,5	74,2	72,4
Temperatura dimnih plinov pri min.moči	°C	62,8	63,1	63,4
Tok dimnih plinov pri nazivni moči	kg/s	0,0065	0,0080	0,0096
Tok dimnih plinov pri minimalni moči	kg/s	0,0031	0,0038	0,0045
Padec tlaka v kotlu	mBar	15	15	15
Območje delovne temperature	°C	55+85	55+85	55+85
Max. temperatura dviznega voda	°C	85	85	85
Min. temperatura povratnega voda	°C	55	55	55
Volumen kurišča	l	37,5	37,5	37,5
Dovoljen delovni tlak	bar	2	2	2
Prostornina posode za vodo v kotlu	l	46	68	90
Masa kotla z gorilcem (brez podajal. in zalog.)	kg	220	243	272
Masa zalogovnika za pelete	kg	30	30	30
Zunanji premer dimne odprtine	mm	Ø 133	Ø 159	Ø 159
Premer priključkov dviž. / povr. voda	"	1,25	1,25	1,25
Premer priključka za dodatni izpust	"	0,5	0,5	0,5
Višina-širina-globina kotla	mm	970-595-1090	970-595-1090	970-595-1090
Višina dimnega priključka	mm	721	688	688
Poraba električne energije	W	13,1	24,7	27,4
Poraba električne energije v mirovanju	W	9	9	9
Priključna napetost kotla / zaščita	230V~/50Hz, 6,3A/250V~			
Nivo zaščite	IP	40	40	40
Nivo hrupa (EN ISO 12100:2010)	dB	<60	<60	<60
Deluje z ventilatorjem	da (v gorilniku)			
Emisijski razred kotla	PN-EN 303-5:2012	5	5	5
Napajanje	AC 230V / 50HZ / 6A			
Poraba energije	W	24,7	24,7	24,7
Električna zaščita	EN 60335 - 1 EN 60335 - 2 102			
Stopnja zaščite	IP	40	40	40

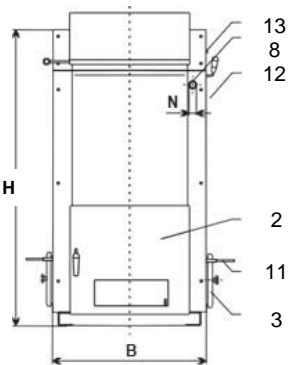
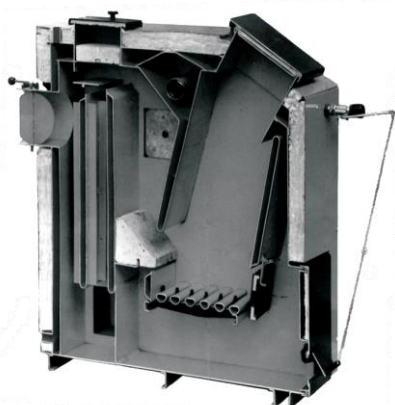

KOTEL NA TRDA GORIVA ZA CENTRALNO OGREVANJE

Koda	Naziv	Moč (kW)	Cena
TKM18	Kotel MEGAL TKM18	12-18	1.471,81
TKM25	Kotel MEGAL TKM25	18-25	1.685,00
TKM32	Kotel MEGAL TKM32	25-32	1.735,33
TKM40	Kotel MEGAL TKM40	32-40	1.870,02
TKM50	Kotel MEGAL TKM50	40-50	2.499,00

Dodatna oprema:

Koda	Naziv	Cena
TKMSPIRALA	Hladilna spirala Megal	164,47

Kotel MEGAL TKM je namenjen predvsem za kurjenje s trdim gorivom - lesom, in srednje kaloričnimi premogi višje granulacije nad 30 mm. Bistvene prednosti kotlov TKM so: čisto in popolno izgorevanje zagotavlja visok izkoristek in minimalni izpust škodljivih delcev, dolgotrajno gorenje enega polnjenja, pri polni obremenitvi več kot 7 ur in več kot 12 ur pri polovični obremenitvi, nalaganje skozi posebna velika vrata, nova regulacija, ki omogoča dobro regulacijo tudi pri zmanjšani obremenitvi, preprosto nalaganje med delovanjem kotla, povratek ogrevne vode in s tem zmanjšanje možnosti za nizkotemperaturno korozijo.

Poleg visokega izkoristka goriva imajo kotli tipa TKM tudi konstrukcijske lastnosti, ki zagotavljajo vrhunsko kvaliteto in dolgo življenjsko dobo kotlov.

Preizkušeno po Standardu EN 303-5 in Direktivi PED 2014/68 EU (Modul B).

SESTAVA KOTLOV

- Vrata za nalaganje
- Vrata za čiščenje pepela
- Odprtine za čiščenje dimnih plinov
- Odvod tople vode v napeljavo
- Dovod ohlajene vode iz napeljave
- Polnjenje – praznjenje kotla
- Priključek regulatorja vleka
- Zaščitni vod
- Priključek varnostnega ventila
- Ročaj za čiščenje pepela
- Ročica preklopnika (vžig – gretje)

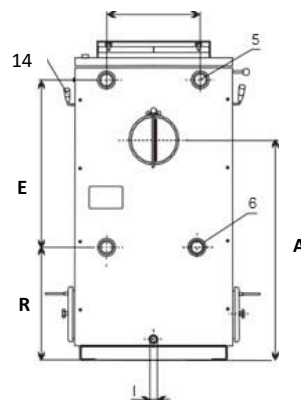
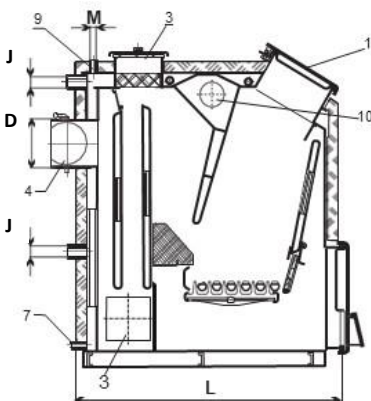

TEHNIČNI PODATKI

MEGAL	TKM	Nazivna moč (les, peleti, premog goilec) (kW)	Teža kotla (kg)	Volumen vode v kotlu (l)	Min. vlek dimnika (Pa)	Min. presek (mm)	Max. delovna temp. (°C)	Max. delovni tlak (bar)	Dimenzije (mm)							Dimenzije (col)				
									H	B	L	A	C	D	R	E	I	J	M	N
	18	12-18	265	92	16	200	90	2.5	1118	480	994	820	260	180	440	590	3/4	5/4	1	3/4
	25	18-25	295	100	16	200	90	2.5	1118	530	994	820	260	180	440	590	3/4	5/4	1	3/4
	32	25-32	330	106	18	200	90	2.5	1118	580	994	820	360	180	440	590	3/4	5/4	1	3/4
	40	32-40	365	108	18	200	90	2.5	1118	630	994	820	360	180	440	590	3/4	5/4	1	3/4
	50	40-50	395	114	21	200	90	2.5	1118	680	994	820	360	180	440	590	3/4	5/4	1	3/4
	65	50-65	520	120	24	250	90	2.5	1118	780	994	950	560	200	590	590	3/4	5/4	1	3/4
	80	65-80	600	135	26	250	90	2.5	1118	880	994	950	660	200	590	590	3/4	5/4	1	3/4
	100	80-100	680	180	29	300	90	2.5	1118	880	1280	1050	660	250	500	780	3/4	5/4	1	3/4

PYROGAS uplinjevalni kotel za kurjenje lesne biomase in briketov



Koda	Naziv		Cena
PYROGAS22	PYROGAS 22	lambda sonda	5.106,92
PYROGAS26	PYROGAS 26	lambda sonda	5.172,80
PYROGAS28	PYROGAS 28	lambda sonda	5.868,20
PYROGAS37	PYROGAS 37	lambda sonda	6.319,60
PYROGAS45	PYROGAS 45	lambda sonda	6.362,30

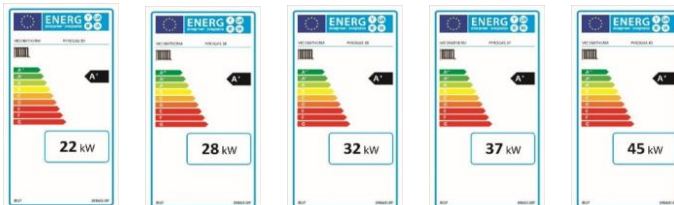

SUBVENCIJA EKO SKLADA



Elektronski krmilnik omogoča nadzor in dostop do varnostnih funkcij. Servomotor Belimo je nameščen na loputi za dovod sekundarnega zraka.

TEHNIČNI PODATKI

Tip kotla	enota	PYROGAS 26	PYROGAS 28	PYROGAS 37	PYROGAS 45
Izhodna moč	kW	27	32	37	45
Razred kotla (STN EN 303-5)		5	5	5	5
Priporočeno gorivo (STN EN 303-5)		les A / lesni briketi C2, maks. stopnja vlage 20%			
Izkoristek	%	89 - 92	89 - 92	89 - 92	89 - 92
Kapaciteta vode	l	80	108	118	118
Povprečna temp. dimnih plinov	°C	136 – 160	136 – 160	136 – 160	136 – 160
Min. temp. povratnega voda	°C	65	65	65	65
Maks. delovni tlak / delovni tlak	bar	2,5 / 1,6	2,5 / 1,6	2,5 / 1,6	2,5 / 1,6
Maks. delovni tlak varnostnega izmenjevalca	bar	6	6	6	6
Volumen zgorevalne komore	l	108	147	187	187
Dimenzije kotla (š x v x d)	mm	530 x 1260 x 1000	530 x 1260 x 1200	530 x 1430 x 1200	530 x 1430 x 1200
Vlek dimnika	Pa	22 – 24	23 – 25	23 – 25	23 – 25
Celotna teža	kg	425	520	566	581
Dimenzije posode za pepel (š x v x d)	mm	380 x 70 x 520	380 x 70 x 720	380 x 70 x 720	380 x 70 x 720
Dimenzije nalagalne odprtine (š x v x d)	mm	390 x 490	390 x 490	390 x 510	390 x 510
Premer dimne odprtine	mm	152	152	152	152
Napajanje / frekvenca	V / Hz	230 / 50	230 / 50	230 / 50	230 / 50
Vhodna električna moč	W	50	50	50	50
Zaščita IP	IP	40	40	40	40
Princip delovanja		Kotel obratuje v pogojih vakuuma (podtlak)			

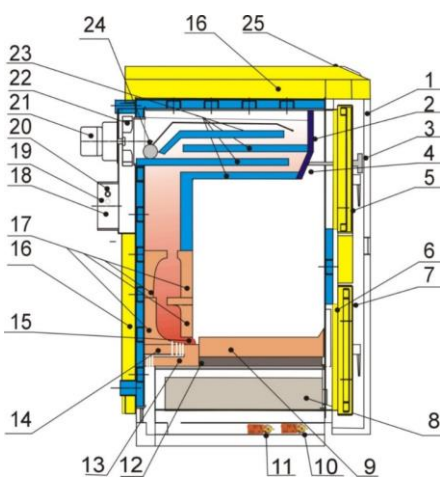

SESTAVA KOTLOV

1. Pot dimnih plinov	13. Rešetka iz litega železa	25. Primarna šoba iz ognjevarnega betona
2. Okvir	14. Posoda za pepel	26. Izgorevalna komora iz ognjevarnega betona LACFIRE
3. Prednja stranica	15. Ploskovni usmerjevalnik	27. Navpične vodne lamele
4. Odstranljiva stranica okvirja	16. Stranici iz ognjevarnega materiala	28. Izhod za dimno cev
5. Matica lopute vleka	17. Servomotor sekundarnega zraka Belimo	29. Temperaturno zaznavalo dimnih plinov
6. Loputa vleka	18. Servomotor primarnega zraka Belimo	30. Lambda sonda Bosch
7. Vrata za nalaganje goriva	19. Pokrov rešetke iz litega železa	31. Sesalni ventilator EBM-PAPST
8. Izvlečna opeka toplotne zaščite	20. Podnožje	32. Propeler sesalnega ventilatorja
9. Opeka iz ognjevarnega materiala	21. Vložki rešetke iz ognjevarnega materiala	33. Elementi toplotnega izmenjevalnika - lamele
10. Vrata rešetke	22. Nastavek izgorevalne komore iz ognjevarnega betona	34. Usmerjevalnik dimnih plinov
11. Spodnja čistilna vrata	23. Nosilec izgorevalne komore	35. Toplotna izolacija
12. Prednja opeka iz ognjevarnega materiala	24. Opeka za sekundarni zrak iz ognjevarnega betona	36. Mikroprocesorski krmilnik AK5000

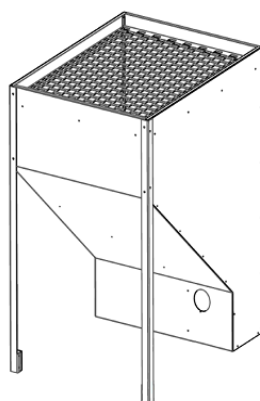
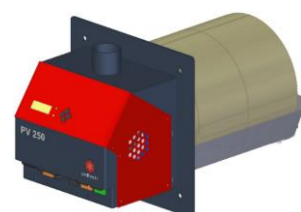

PELETNI GORILNIKI PELLTECH 20kW, 30kW, 50kW

Koda	Naziv	*odprodaja	Cena
PV0021	Peletni gorilnik PV 20a - 20 Kw		1.281,00
PV0031	Peletni gorilnik PV 30a - 30 kW		1.403,00
PV0022	Peletni gorilnik PV 20b - 20 kW samočistilni		1.586,00
PV0032	Peletni gorilnik PV 30b - 30 kW samočistilni		1.708,00
PV0053	Peletni gorilnik PV 50c - 50 kW samočistilni		2.318,00

PELETNI GORILNIKI PELLTECH od 100kW do 1000kW

Koda	Naziv	Cena
PV0104	Avtomatski samočistilni gorilnik PV 100d - 100kW	3.294,00
PV0184	Avtomatski samočistilni gorilnik PV 180d - 180kW	4.514,00
PV0353	Peletni gorilnik PV 350b - 350 kW	10.980,00
PV0502	Peletni gorilnik PV 500a - 500 kW	14.640,00
PV0701	Peletni gorilnik PV 700a - 700 kW	18.300,00
PV1001	Peletni gorilnik PV 1000a - 1000 kW	24.400,00

PELETNI POLŽ PELLTECH 20kW, 30kW, 50kW, 100kW, 1000kW

Koda	Naziv	Cena
PA1525	Peletni polž 1500 mm za 25 W - PV 20a/b, 30a/b, 50b	280,60
PA2025	Peletni polž 2000 mm za 25 W - PV 20a/b, 30a/b, 50b	292,80
PA3025	Peletni polž 3000 mm za 40W - PV 20a/b, 30a/b, 50b	475,80
PA1545	Peletni polž 1500 mm PV 100b	317,20
PA2045	Peletni polž 2000 mm PV 100b	348,92
PA2047	Peletni polž 2000 mm PV 180b	475,80
PA4047	Peletni polž 4000 mm PV 100b/180b	890,60
PA4037	Peletni polž 4000 mm 700kW - PV200a	1.098,00
PA6097	Peletni polž 6000 mm bold PV 100b/180b	1.061,40

ZALOGOVNIK ZA PELETE

Koda	Naziv	Cena
ZAL55	Zalogovnik za pelete 55 x 90 x 122cm (200kg)	341,60
ZAL65	Zalogovnik za pelete 65 x 85 x 122cm (250kg)	353,80

Pocinkana pločevina

Vsa ponudba kaminov HAAS + SOHN je dostopna na www.pilremag.si - SPLETNA TRGOVINA - OGREVANJE

Naziv	WIEN easy 351.15	PYRUS 294.15-ST
Koda	0335115100000	0429415100000
Nazivna toplotna moč	6kW	6kW
Teža	116kg	169kg
Učinkovitost	80%	82%
Razred energijske učinkovitosti	A	A+
Višina / širina / dolžina	1215/482/380	1004 / 540 / 477mm
Vratca kurišča višina / širina	370/400	280 / 300mm
Kurišče višina /širina / globina	470/375/230	341 / 300 / 290mm
Premer dimniškega priključka	150mm	150mm
Višina dimniškega priključka (sredina)	1089	781mm
Emisijske vrednosti dimnih plinov (g/s °C Pa)	5,4/365/12	5,4 / 300 / 12 - 10
Jeklo obdelava	črna	pearl črna, Woodstone Prestige
Keramika		
Cena	2.469,91	2.561,44



Naziv	ARUBA easy 220.17- ST	TIROL 343.15-C
Koda	0422017080000	0434350010000
Nazivna toplotna moč	3-6kW	6kW
Teža	182kg	111kg
Učinkovitost	80%	80%
Razred energijske učinkovitosti	A+	A+
Višina / širina / dolžina	1030 / 700 / 365mm	956 / 668 / 356mm
Vratca kurišča višina / širina	340 / 350mm	213 / 280mm
Kurišče višina /širina / globina	410 / 360 / 220mm	270 / 325 / 240mm
Premer dimniškega priključka	150mm	130mm
Višina dimniškega priključka (sredina)	845mm	zgoraj
Emisijske vrednosti dimnih plinov (g/s °C Pa)	6,2 / 294 / 11	5,9 / 343 / 12
Jeklo obdelava	pearl črna	črna
Keramika	siv kamen-peskan	barvne pečnice (več možnosti)
Cena	2.871,12	2.096,29

Vsa ponudba kaminov HAAS + SOHN je dostopna na www.pilremag.si - SPLETNA TRGOVINA - OGREVANJE

Naziv	HSP 2.17 Selina	HSP 6 WT 537.08 RLU	HSP 6 WT hidravlični modul
	Peletni kamin	Peletna kaminska peč za centralno ogrevanje	za peletno kaminsko peč
Koda	0571407130000	0553708050000	0553808114000
Nazivna toplotna moč	2,4-8,6kW	10kW	
Teža	90kg	176kg	4kg
Učinkovitost	90%	93%	
Razred energijske učinkovitosti	A+	A++	G
Višina / širina / dolžina	966 / 498 / 511mm	1200 / 544 / 498mm	
Kurišče kapaciteta kg	17kg	30kg	
Premer dimniškega priključka	80mm	80mm	
Višina dimniškega priključka (sredina)	270mm	250mm	
Emisijske vrednosti dimnih plinov (g/s °C Pa)	5,7 / 198 / 11	7,4 / 152 / 12	
Jeklo obdelava	pearl črna	pearl antracit /bela	
Opcije	Možnost Wi-fi regulacije	Možnost Wi-fi regulacije	
Cena	3.446,59	5.859,64	718,40



Naziv	LONDON-II EASY BACK 347.15	HSPH 75.5-SF easy
	Kamin na drva s pečico	Štedilnik na drva
Koda	0434715300000	07075522340000
Nazivna toplotna moč	8kW	8kW
Teža	194kg	135kg
Učinkovitost	80%	80%
Razred energijske učinkovitosti	A+	A+
Višina / širina / dolžina	1226 / 694 / 464mm	850-880 / 750 / 600mm
Vratca kurišča višina / širina	250 / 500mm	200 / 175mm
Kurišče višina / širina / globina	300 / 530 / 245mm	250 / 215 / 410mm
Premer dimniškega priključka	150mm	120mm
Višina dimniškega priključka (sredina)	zgoraj	690-710mm
Emisijske vrednosti dimnih plinov (g/s °C Pa)	6,5 / 315 / 12	8,8 / 250 / 12
Jeklo obdelava	pearl antracit	antracit
Cena	3.609,58	3.107,67

OLJNI KOTEL JAKA HFS (brez gorilnika)

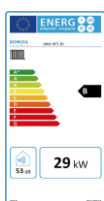

B

Koda	Priporočeni gorilnik	Moč (kW)	Cena
JAKA HFS 30	DOMESTIC D3	28,1	838,73
JAKA HFS 40	DOMESTIC D4	39,4	908,41
JAKA HFS 50	DOMESTIC D4	50,8	1.110,00
JAKA HFS 60	DOMESTIC D6	60,7	1.200,85
JAKA HFS 70	DOMESTIC D6	71,4	1.391,24
JAKA HFS 80	DOMESTIC D10	83,3	1.557,99

OLJNI GORILNIK DOMESTIC



Koda	Teža (kg)	Moč (kW)	Cena	
DOMESTIC D-3	11,7	17,7 - 36	457,50	
DOMESTIC D-3P	predgretje	11,7	17,7 - 36	513,62
DOMESTIC D-4	11,7	27,2 - 55	467,26	
DOMESTIC D-4P	predgretje	11,7	27,2 - 55	531,92
DOMESTIC D-6	15	52 - 85	530,70	
DOMESTIC D-10	15	70 - 116	685,64	

KONDENZACIJSKI OLJNI KOTEL HFD



A

Koda	Moč (kW)	Cena
JAKA HFD 20 CONDENS	20,3	2.476,36
JAKA HFD 30 CONDENS	30,2	2.961,67

KONDENZACIJSKI OLJNI KOTEL EVOLUTION



A

Koda	Moč (kW)	Cena
EVOLUTION EV 25 HAC	29,3	3.219,26
EVOLUTION EV 35 HAC	40,5	3.552,76

KONDENZACIJSKI OLJNI KOTEL HFD CONDENS (zunanja montaža)

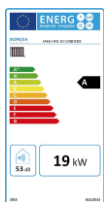

A

Koda	Moč (kW)	Cena
JAKA HFD 20 CONDENS OD	20,3	2.974,12
JAKA HFD 30 CONDENS OD	30,2	3.148,33
JAKA HFD 40 CONDENS OD	40,5	3.347,44

KONDENZACIJSKI OLJNI KOTEL MINNY (vgradnja v kuhinjo)



A

Koda	Moč (kW) 80°C/60°C	Cena
MINNY 2D	20	2.961,67
MINNY 3D	30	3.223,00
Možna vgradnja med kuhinjske elemente.		

TEHNIČNI PODATKI

	Simbol	Enota	JAKA HFS 30	JAKA HFS 40	JAKA HFS 50	JAKA HFS 60	JAKA HFD20 CONDENS	JAKA HFD30 CONDENS	EVOLUTION EV 25 HAC	EVOLUTION EV 35 HAC
Nazivna toplotna moč	$P_{nazivna}$	kW	29	40	50	60	19	30	27	37
Kondenzacijski kotel			NE	NE	NE	NE	DA	DA	DA	DA
Energijski razred										

Dejanska toplotna moč za ogrevalne in kombinirane kotle:

Pri nazivni toplotni moči in visokotemperaturnem režimu delovanja	P_4	kW	28,1	39,4	50,8	60,7	19	28,7	27,1	37,4
Pri 30% nazivne toplotne moči in nizkotemperaturnem režimu delovanja	P_1	kW	8,9	12,1	15,6	18,6	6,1	8,5	8,8	12,2
Dodatna poraba električne energije										
Pri polni obremenitvi	$e_{l_{max}}$	kW	0,152	0,161	0,161	0,226	0,226	0,226	0,226	0,226
Pri delni obremenitvi	$e_{l_{min}}$	kW	0,055	0,056	0,056	0,078	0,078	0,078	0,078	0,078
V stanju pripravljenosti	P_{SB}	kW	0,003	0,003	0,003	0,001	0,001	0,001	0,001	0,001
Deklarirana obremenitev										
Dnevna poraba električne energije	Q_{elec}	kWh								
Energijski izkoristek naprave pri sezonskem ogrevanju	η_s	%	90	87	86	86	90	91	90	92
Dejanski izkoristek za ogrevalne in kombinirane kotle										
Pri nazivni toplotni moči in visokotemperaturnem režimu delovanja	η_4	%	86,3	89,3	89,1	89,1	91	92,4	92,1	91,1
Pri 30% nazivne toplotne moči in nizkotemperaturnem režimu delovanja	η_1	%	92	91,4	90,8	90,8	97,9	97,6	98,1	97,9
Ostali podatki										
Toplotne izgube v stanju pripravljenosti	P_{stby}	kW	0,106	0,094	0,141	0,182	0,127	0,135	0,12	0,09
Poraba električne moči vžigalnega grelca	P_{ign}	kW								
Emisije dušikovih oksidov	NO_x	mg / kWh	126	105	128	133	92	118	114	117
Izkoristek energije pri ogrevanju vode	η_{wh}	%								
Dnevna poraba kuriva	Q_{fuel}	kWh								
Nizkotemperaturni kotel			DA	DA	DA	DA	NE	NE	NE	NE
B1 kotel			NE	NE	NE	NE	NE	NE	NE	NE
Kogeneracijski ogrevalni kotel			NE	NE	NE	NE	NE	NE	NE	NE
Možnost dodatnega grelca			NE	NE	NE	NE	NE	NE	NE	NE
Kombinirani kotel			NE	NE	NE	NE	NE	NE	NE	NE

ENOSLOJNI DIMNIKI IZ NERJAVEČE PLOČEVINE

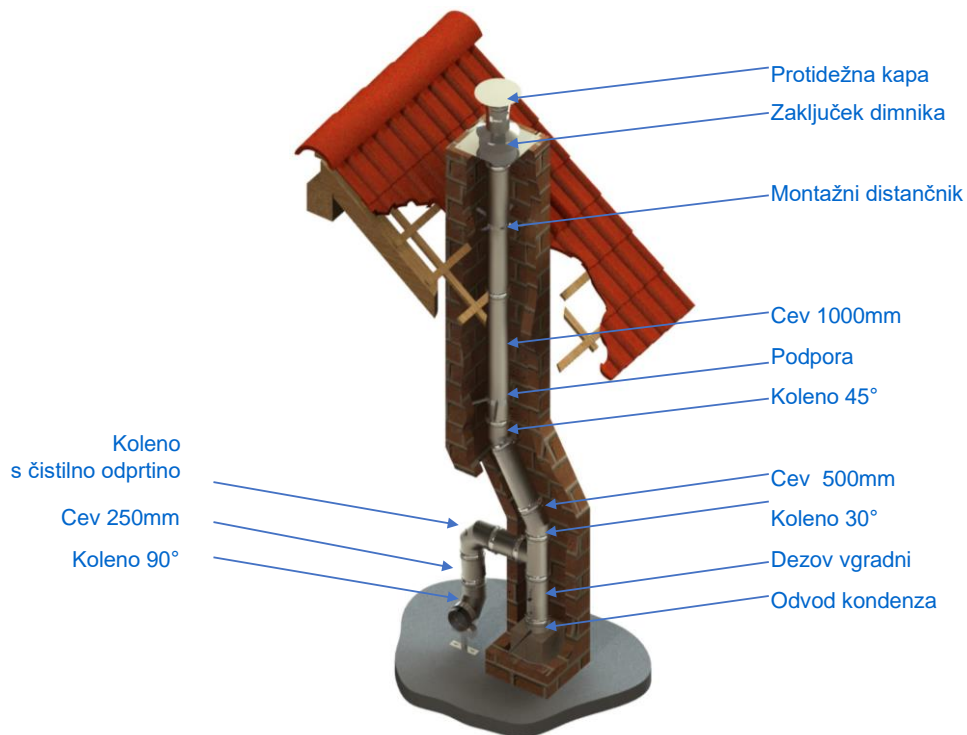

*Po naročilu

ČISTILNI ELEMENTI	Odvod kondenza 250mm	Dezov vgradni čistilni pokrov 210x140mm	Dezov veliki 210 x 480mm	Podaljšek za dezov	Dezov vgradni revizijski 500mm	Cev z revizijsko odprtino (do 600°C)
Koda	FU01B	FU0607	FU0634	FU11	FU06113	FU0607R
Ø060*	27,25				76,80	
Ø080	27,25	54,00	50,81		76,80	116,31
Ø100	31,48	57,12	50,81		85,17	116,31
Ø110	32,07	57,12	51,29		85,70	168,58
Ø115*	33,17	57,12	51,29		87,84	116,31
Ø120	33,17	59,15	54,02		97,90	122,65
Ø130	33,68	61,32	55,66		100,13	131,13
Ø140	34,49	63,38	56,14	15cm	100,69	133,16
Ø150	35,28	67,66	56,70	31,79	101,79	133,16
Ø160	36,92	69,81	58,84		104,58	141,61
Ø180	38,52	74,03	60,93		105,18	145,95
Ø200	40,69	84,55	69,50		117,94	160,69
Ø225*	41,74	88,77	74,88		121,77	169,09
Ø250	43,37	99,40	86,12		125,24	177,55
Ø300*	48,13	118,39	101,17		149,14	183,92
Ø350*		141,61			192,37	217,73
Ø400*		175,49			205,08	253,72
Ø450*		200,85		50cm	224,10	281,20
Ø500*		219,79		93,03	251,58	310,79



*Po naročilu

VRATCA T-KOSI	Vratca velika gola	Vratca velika z nastavkom	Vratca velika nihajna 210 x140mm	T- kos 87°	T- kos 45°	T- kos klix 87°
Koda	FU13	FU0960PL	FU35	FU0615	FU0616	FU0649
Ø060*	dim.	dim.		34,27	45,01	
Ø080	210x140	210x140		34,75	45,71	61,80
Ø100	mm	mm	83,08	37,96	51,01	67,95
Ø110	58,34	71,86		40,10	53,88	73,41
Ø115*				42,24	56,87	77,36
Ø120				45,49	58,59	82,29
Ø130				48,67	66,28	86,80
Ø140				50,81	73,81	83,02
Ø150				52,98	81,45	90,66
Ø160				56,93	95,23	99,60
Ø180				60,93	109,04	110,76
Ø200				75,47	126,48	123,52
Ø225*				86,60	151,17	136,85
Ø250				97,85	183,89	153,00
Ø300*				125,13	239,55	175,83
Ø350*					301,04	218,16
Ø400*					310,26	340,33
Ø450*					345,00	
Ø500*					389,00	



*Po naročilu

CEVI	Cev 1000mm	Cev 500mm	Cev 250mm	Cev 1000mm z zanko za sanacijo	Cev 1000mm z dvojno mužno žiž	Cev 250mm z dvojno mužno žiž
Koda	FU0602	FU0603	FU0604	FU0605	FU0606	FU061879
Ø060*	32,61	17,70	10,68	34,27	36,83	
Ø080	34,27	18,74	11,24	36,33	38,44	15,42
Ø100	43,37	20,85	13,36	44,92	47,51	17,56
Ø110	44,41	23,05	14,46	46,02	48,61	19,11
Ø115*	44,92	24,60	15,50	46,58	49,15	19,70
Ø120	50,81	25,65	17,70	52,45	55,04	21,93
Ø130	52,98	27,79	19,84	54,56	57,18	24,07
Ø140	55,88	29,93	21,36	57,49	60,11	25,62
Ø150	58,84	32,07	23,05	60,51	63,10	27,22
Ø160	67,38	34,27	24,10	69,02	71,67	28,35
Ø180	75,98	36,33	25,19	77,59	80,23	29,42
Ø200	89,79	46,02	27,79	91,48	94,10	32,04
Ø225*	98,38	50,81	31,48	100,02	102,61	35,73
Ø250	115,01	57,77	35,28	116,62	119,18	39,54
Ø300*	131,13	64,68	40,69	132,65	135,27	44,87
Ø350*	183,92	112,05	67,66	188,17	188,17	142,43
Ø400*	228,33	137,42	82,43	232,53	232,53	
Ø450*	274,86	164,89	99,40	279,09	279,09	
Ø500*	319,22	192,37	116,31	323,44	323,44	



*Po naročilu

KOLENA	Koleno 90°	Koleno 45°	Koleno 30°	Koleno 87° s čistilno odprtino	Koleno nastavljivo 0°-90°	Koleno nastavljivo 0-90° s čistilno odprtino
Koda	FU0629N	FU0619N	FU0618N	FU0623N	FU06101	FU06102
Ø060*	32,61	24,07	23,56			
Ø080	33,68	24,60	24,07	49,74	36,33	50,76
Ø100	43,37	25,36	25,36	59,32	38,52	52,84
Ø110	47,09	32,07	31,48	63,10	40,69	81,28
Ø115*	48,61	25,36	25,36	67,38	50,76	56,67
Ø120	50,81	25,39	27,53	72,23	45,49	56,67
Ø130	52,98	27,56	29,56	74,88	38,10	57,83
Ø140	55,04	29,59	31,79	81,05	52,84	59,04
Ø150	59,27	29,59	31,79	87,17	40,27	60,25
Ø160	65,66	33,82	35,96	95,17	61,32	122,93
Ø180	82,63	35,99	38,02	105,85	72,82	157,88
Ø200	103,23	42,39	44,41	119,21	81,39	157,48
Ø225*	115,49	50,81	52,84	131,58	145,95	192,37
Ø250	125,61	59,27	61,32	141,25	118,76	188,03
Ø300*	134,26	93,03	93,03	150,83	205,08	225,88
Ø350*	219,79	97,20	97,20	270,58		
Ø400*	257,92	112,05	112,05	298,11		
Ø450*	304,42	122,65	122,65	333,98		
Ø500*	357,29	141,61	141,61	393,20		



*Po naročilu

FLEKSIBILNE CEVI	Dimniška cev nastavljiva 320-480mm	Cev fleksibilna	Adapter Flex-Flex	Adapter Flex-FU	Adapter FU-Flex
Koda	FU06114	121-F01	FD06	FD07	FD08
Ø060*	41,09				
Ø080	41,74	33,62	40,19	33,76	33,76
Ø100	50,81	41,77	46,56	38,02	38,02
Ø110	52,98	45,91	46,56	40,19	40,19
Ø115*	55,66		50,76	42,33	40,19
Ø120	58,84	50,39	50,76	42,33	40,19
Ø130	61,49	53,80	52,84	44,41	42,33
Ø140	103,63	58,11	54,93	46,56	44,41
Ø150	70,62	62,31	59,15	46,56	46,56
Ø160	116,31	66,28	61,32	48,61	48,61
Ø180	82,94	73,41	65,58	52,84	50,76
Ø200	90,38	82,26	71,86	57,12	54,93
Ø225*	100,02				
Ø250	140,18				
Ø300*	167,46				
Ø350*	215,62				
Ø400*	226,22				
Ø450*	249,47				
Ø500*	266,32				



*Po naročilu

ZAKLJUČNI ELEMENTI	Zaključek dimnika	Protidežna kapa	Dimniški pokrov	Dimniški pokrov revizijski	Dimniški pokrov s tesnilom za T-kos	Tesnilo silikonsko
Koda	EW0626	FU28	FU43	FU50	ALBI31	ALBI26
Ø060*		14,99				
Ø080	33,17	15,50	38,02	39,23	59,15	3,52
Ø100	34,75	16,06	38,02	43,54	59,15	4,71
Ø110	36,33	17,13				4,71
Ø115*	37,45	17,70	38,02	47,94	59,15	4,71
Ø120	37,96	19,84	40,19	50,11	65,30	5,27
Ø130	38,52	23,05	40,19	56,62	65,30	5,27
Ø140	41,20	24,94	40,19	57,12	65,30	5,27
Ø150	43,79	26,80	42,33	56,62	65,30	5,27
Ø160	47,37	29,45	44,41	56,62	65,30	6,40
Ø180	50,81	32,07	46,56	56,62	65,30	6,40
Ø200	56,70	34,75	48,61	67,52	71,39	6,40
Ø225*	65,18	43,79	50,76			7,10
Ø250	103,23	54,93	52,84	67,52	71,39	7,10
Ø300*	119,21	63,38	57,12	76,12	80,40	8,17
Ø350*		76,12	76,12			8,82
Ø400*		90,92	84,55			9,95
Ø450*		105,71	97,20			11,64
Ø500*		209,34	120,53			13,47



*Po naročilu

PRITRDILNI ELEMENTI	Montažni distančnik	Rozeta	Objemka	Zidno držalo	Dilatacijski element za vgradnjo - pritrnitev v steno	Izolacija 25mm
Koda	FU40	FU72	FU45	VL09	FU42	FU39....-25
Ø060*	8,93	23,90	9,47	40,72	31,17	
Ø080	8,93	23,90	9,47	40,72	29,56	32,30
Ø100	19,05	27,25	10,60	45,68	29,56	32,30
Ø110	23,25	27,25	10,60	46,81	29,56	35,06
Ø115*	23,25	27,25	10,60	46,56	29,56	35,59
Ø120	23,25	27,25	10,60	46,56	31,79	35,59
Ø130	25,36	27,25	10,60	46,56	33,76	36,75
Ø140	25,36	27,25	10,60	46,56	35,96	40,69
Ø150	27,53	31,17	12,65	46,56	35,96	43,43
Ø160	27,53	31,17	12,65	46,56	38,02	47,85
Ø180	27,53	31,17	12,65	52,84	40,19	54,00
Ø200	27,53	35,59	14,85	52,84	40,19	60,62
Ø225*	27,53	35,59	16,99	54,93	46,56	67,30
Ø250	29,56	40,19	21,81	54,93	48,61	76,23
Ø300*	29,56	40,19	25,36	71,86	54,93	83,45
Ø350*	31,79	57,12	27,53	84,55	67,66	128,99
Ø400*	31,79	80,38	31,79	97,20	84,55	162,72
Ø450*	33,76	105,71	38,02	114,11	154,32	190,23
Ø500*	54,93	112,05	54,93	160,69	190,23	

EWR REDUCIRNI KOSI

iz Ø / na Ø	80/60								
cena	30,07								
iz Ø / na Ø	100/80								
cena	34,49								
iz Ø / na Ø	110/80	110/100							
cena	35,59	35,59							
iz Ø / na Ø	115/80	115/100	115/110						
cena	38,42	38,02	38,42						
iz Ø / na Ø	120/80	120/100	120/110	120/115					
cena	40,07	38,02	40,07	40,08					
iz Ø / na Ø	130/80	130/100	130/110	130/115	130/120				
cena	42,33	42,33	40,19	42,33	42,33				
iz Ø / na Ø	140/80	140/100	140/110	140/115	140/120	140/130			
cena	44,56	44,56	44,56	44,55	40,19	44,56			
iz Ø / na Ø	150/80	150/100	150/110	150/120	150/130	150/140			
cena	51,12	51,12	51,12	51,12	40,19	51,12			
iz Ø / na Ø	160/80	160/100	160/110	160/120	160/130	160/140	160/150		
cena	52,28	52,28	52,28	52,28	52,28	44,41	52,28		
iz Ø / na Ø	180/80	180/100	180/110	180/120	180/130	180/140	180/150	180/160	
cena	58,39	58,39	58,39	58,39	58,39	58,39	58,39	48,61	
iz Ø / na Ø	200/80	200/110	200/120	200/130	200/140	200/150	200/160	200/180	
cena	64,59	64,59	29,00	64,59	64,59	64,59	64,59	50,76	
iz Ø / na Ø			250/150	250/160	250/180	250/200	250/220		
cena			98,44	98,44	98,44	98,44	98,44		
iz Ø / na Ø			300/150	300/160	300/180	300/200	300/250	350/300	400/350
cena			105,18	105,18	105,18	105,18	105,18	162,72	186,06

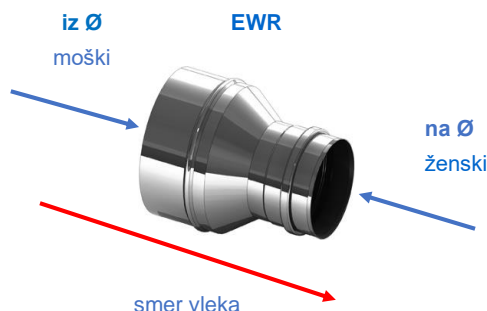

EWE KONTRAREDCIRNI KOSI

iz Ø / na Ø	60/80	60/100	60/110	60/130						
cena	30,07	34,49	35,59	42,33						
iz Ø / na Ø	80/100	80/110	80/120	80/130	80/140	80/150	80/160	80/180	80/200	
cena	34,49	35,59	40,07	42,33	44,56	51,12	52,28	58,39	64,59	
iz Ø / na Ø	100/110	100/115	100/120	100/130	100/140	100/150	100/160	100/180	100/200	100/250
cena	35,59	38,42	38,02	42,33	44,56	51,12	93,03	58,39	64,59	98,44
iz Ø / na Ø	110/120	110/130	110/140	110/150	110/160	110/180	110/200			
cena	38,02	38,02	44,56	51,12	93,03	58,39	64,59			
iz Ø / na Ø	115/120	115/130	115/140	115/150	115/160					
cena	40,08	40,19	44,55	51,12	52,28					
iz Ø / na Ø	120/130	120/140	120/150	120/160	120/180	120/200	120/250			
cena	42,33	40,19	51,12	52,28	58,39	64,59	98,44			
iz Ø / na Ø	130/140	130/150	130/160	130/180	130/200	130/250				
cena	44,56	40,19	52,28	58,39	64,59	98,44				
iz Ø / na Ø	140/150	140/160	140/180	140/200						
cena	51,12	44,41	58,39	64,59						
iz Ø / na Ø	150/160	150/180	150/200	150/250	150/300	150/350				
cena	52,28	58,39	64,59	98,44	105,18	127,95				
iz Ø / na Ø	160/180	160/200	160/250	160/300						
cena	48,61	64,59	98,44	105,18						
iz Ø / na Ø	180/200	180/250	180/300							
cena	50,76	98,44	105,18							
iz Ø / na Ø	200/250	200/300	200/350	200/400	200/450					
cena	98,44	105,18	127,95	146,35	163,09					
iz Ø / na Ø	250/300	300/450	350/450	500/600						
cena	105,18	108,70	205,08	253,72						

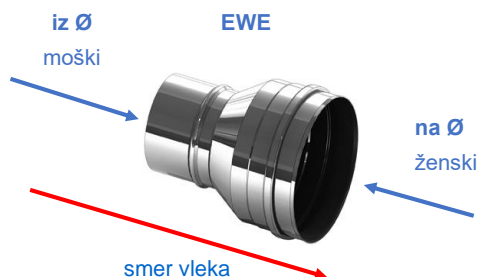

TROSLOJNI DIMNIKI

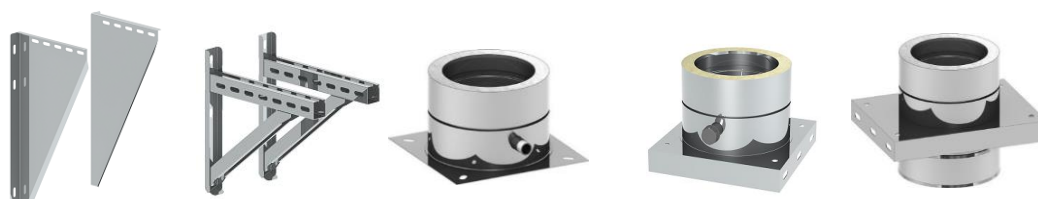
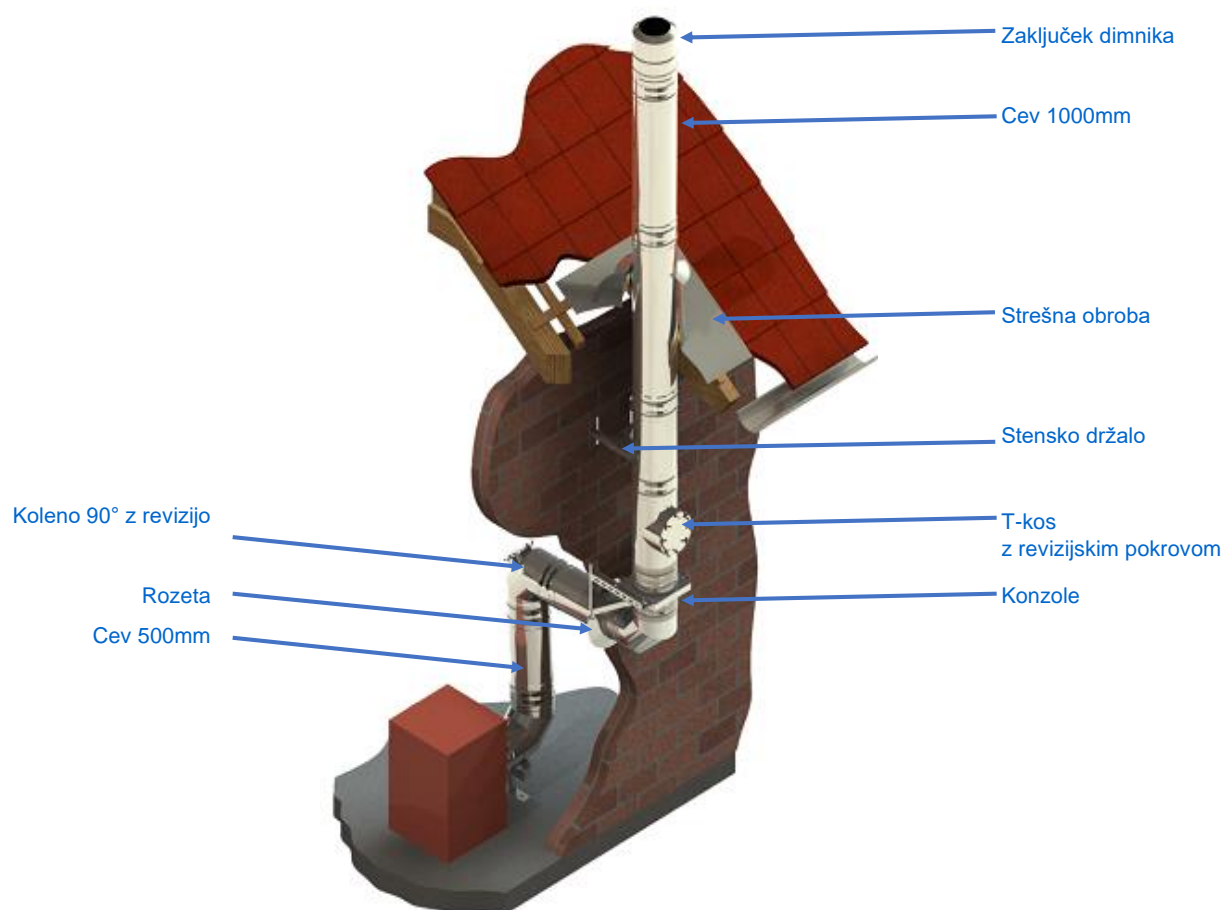

* Po naročilu

OSNOVE in ODVODI KONDENZA	Konzole 50-150mm	Konzole tip L dol.35cm	Odvod kondenza talni	Odvod kondenza konzolni	Cev s konzolnim priključkom
Koda	DW01	DW391	205-DWETN66	205-DWETN06	205-DWETN07
Ø080 *	86,66	154,78	62,08	75,98	80,66
Ø100 *	86,66		69,02	83,42	88,29
Ø110 *			72,23	88,77	92,55
Ø130	88,77		81,39	101,68	103,74
Ø150	97,20		91,48	113,94	115,01
Ø160	122,65		99,26	124,31	124,93
Ø180	131,13		106,95	134,85	134,85
Ø200	145,95		116,62	142,83	146,60
Ø225 *	241,01		130,54	153,54	158,33
Ø250	283,29		145,45	188,26	190,93
Ø300 *	317,08		182,34	217,65	224,13
Ø350 *	372,03		203,78	229,99	272,83
Ø400 *	505,19		243,38	254,03	303,21
Ø450 *	579,22		285,62	316,68	339,06
Ø500 *	655,29		330,63	363,18	400,10



* Po naročilu

ČISTILNI ELEMENTI	Dezov veliki z vrati	Cev z revizijsko odprtino	Cev 1000 mm	Cev 500 mm	Cev 250 mm	Rozeta
Koda	205-DWETN10	205-DWETN68	205-DWETN13	205-DWETN14	205-DWETN15	DWECO307
Ø080 *	185,04	323,44	106,95	62,56	36,92	19,30
Ø100 *	220,86	336,13	124,71	76,99	48,13	21,36
Ø110 *	227,26	124,06	129,41	80,66	48,67	21,36
Ø130	244,42	138,49	150,83	90,92	52,98	21,98
Ø150	250,31	173,85	167,91	103,63	59,89	23,05
Ø160	269,34	179,15	181,60	114,11	64,71	24,07
Ø180	288,27	184,56	195,22	122,65	69,50	25,19
Ø200	318,26	209,62	219,31	131,13	75,98	29,48
Ø225 *	325,76	224,13	235,35	154,04	87,73	34,78
Ø250	333,25	251,95	264,26	167,01	96,86	37,48
Ø300 *	388,32	313,98	334,86	191,47	120,31	42,33
Ø350 *	418,76	336,94	371,75	205,42	129,41	48,70
Ø400 *	497,95	371,75	433,83	239,60	151,28	59,44
Ø450 *	546,00	432,68	489,97	277,56	166,33	69,58
Ø500 *	570,71	458,41	542,36	312,43	186,62	82,43



* Po naročilu

PRIKLJUČNI ELEMENTI	T kos 45°	T kos 90°	Koleno 30°	Koleno 45°	Koleno 90°	Koleno 87° s čistilno odprtino
Koda	205-DWETN12	205-DWETN11	205-DWETN17	205-DWETN18	205-DWETN60	205-DWETN19
Ø080 *	137,44	99,48	66,79	75,98	95,79	386,88
Ø100 *	152,41	120,31	87,17	93,54	112,36	391,08
Ø110 *	160,44	128,90	91,48	101,68	122,99	127,61
Ø130	186,62	165,23	105,71	112,84	140,15	137,44
Ø150	215,56	170,67	118,39	118,39	164,27	166,33
Ø160	241,49	190,93	124,79	124,79	172,45	176,19
Ø180	267,45	211,22	131,13	128,99	180,70	186,17
Ø200	284,05	233,21	135,27	150,18	202,77	204,85
Ø225 *	339,65	266,91	184,03	191,47	240,14	
Ø250	431,61	296,33	143,81	175,49	304,37	301,18
Ø300 *	547,69	381,39	207,14	239,60	371,75	479,94
Ø350 *	752,57	465,31	247,02	265,31	376,57	606,70
Ø400 *	772,36	530,50	306,48	360,50	432,68	718,84
Ø450 *	888,35	621,47	371,16	371,16	503,25	744,09
Ø500 *	1.353,13	909,71	406,47	464,13	695,87	898,44

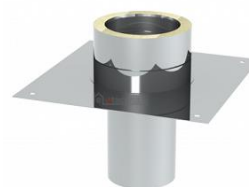

* Po naročilu

ZAKLJUČNI ELEMENTI	Protidežna kapa	Zaključek s protivetno kapo	Izoliran zaključek dimnika	Zaključni kos EN/DW enoslojni/ troslojni
Koda	215-DWECO33	205-DWETN92HS	205-DWETN32	205-DWETN08
Ø080 *	42,75		37,96	84,52
Ø100 *	50,81		44,92	92,55
Ø110 *	54,56		46,02	96,86
Ø130	64,71	120,39	50,81	109,04
Ø150	76,49	134,34	57,77	120,31
Ø160	86,12	144,83	63,38	130,74
Ø180	95,79	150,04	69,02	141,16
Ø200	99,48	167,51	72,23	153,54
Ø225 *	124,71	183,18	79,70	166,33
Ø250	148,66	198,88	87,17	200,57
Ø300 *	175,49	266,94	97,37	235,35
Ø350 *	181,77		134,26	286,16
Ø400 *	200,85		162,58	318,79
Ø450 *	230,44		215,03	356,22
Ø500 *	257,92		250,31	419,91



* Po naročilu

PREHODI, PRITRDILNI ELEMENTI	Prehodni kos EN/DW enoslojni/ troslojni	Prehodni kos DW/EN enoslojni/ troslojni	Zidno držalo nastavljivo 50-70mm	Čep z odvodom kondenza za konzole
Koda	205-DWETN37	205-DWETN37A	DWECO690	215-DWECO44
Ø080 *	36,33	52,84	21,16	143,81
Ø100 *	44,41	52,84	23,25	147,98
Ø110 *	46,02			
Ø130	50,30	50,30	25,36	158,55
Ø150	57,12	57,12	29,56	56,19
Ø160	57,12	57,12	31,79	58,36
Ø180	61,32	61,32	31,79	179,74
Ø200	67,66	67,66	33,76	84,69
Ø225 *	79,70			
Ø250	67,66	67,66	40,19	101,74
Ø300 *	74,03	74,03	44,41	230,44
Ø350 *	86,66	86,66	50,76	289,65
Ø400 *	107,80	135,27	52,84	325,59
Ø450 *	128,99	128,99	57,12	382,71
Ø500 *	141,61	158,55		441,84

*Po naročilu

TROSLOJNI DIMNIKI DW-BLACK (25mm izolacije)



DW-BLACK je troslojni dimniški sistem z notranjo cevjo iz nerjavečega jekla in zunanjo cevjo iz pocinkane pločevine, barvane s komaxitom. Primeren je za vse običajne kurilne naprave; s posebnim notranjim tesnilom je primeren tudi za kotle z nadtlakom (do 200 Pa) v mokrem načinu delovanja. Ta sistem je bil razvit za izgorevanje plina in olja za bivalne, poslovne ali industrijske objekte, z delovno temperaturo 120 °C in nadtlakom 200 Pa. EN 1856-1 T120 P1 W V2-L99050 G00.



KONZOLE	Konzola 350mm	Konzola 500mm	Konzola 750mm	Konzola 1030mm
	16-DW391	16-DW392 *	16-DW393 *	16-DW407 *
Ø130	105,47	110,11	170,37	239,91

*Po naročilu

TROSLOJNI DIMNIKI DW-BLACK (25mm izolacije)



ODVODI KONDEZA ČISTILNI KOSI	Odvod kondenza s podstavkom	Cev s konzolno ploščo	Odvod kondenza talni	Plošča za dvig dimnika T450°C / N1	Čistilni kos z revizijsko odprtino 450 °C/N1	Revizijski kos (do 600°C/N1) vratca 210x140	Revizijski kos horizontalni (do 600°C/N1)
	16-290- DWETN05	16-290- DWETN07	16-290- DWETN66	16-290- DWETN08	16-290- DWETN2747	16-205- DWETN10	16-205- DWETN68
Ø130	95,04	100,83	104,31	81,13	253,82	394,06	144,88
Ø150	98,52	108,95	113,58	84,61	274,68	414,92	152,99
Ø180	107,79	120,54	121,70	100,83	288,59	428,83	163,42
Ø200	114,74	137,92	133,29	117,06	296,70	449,69	175,01



CEVI	Cev 1000mm	Cev 500 mm	Cev 250mm	Cev 500mm z nastavkom za FERRO, nastavljiva	Adapter EW/DW-ECO	Sprej RAL9011MB
	16-290- DWETN13	16-290- DWETN14	16-290- DWETN15	16-290- DWETN1661	16-290- DWETN37	RAL9011MB- CSPRAY
Ø130	118,22	74,18	48,68	111,26	42,88	42,88
Ø150	127,49	78,81	52,16	124,01	51,00	
Ø180	148,35	89,24	59,11	156,47	53,31	
Ø200	158,78	95,04	62,59	163,42	60,27	



KOLENA	Koleno 15°	Koleno 30°	Koleno 45°	Koleno 87°	Koleno 90°	T-kos 87°
	16-290- DWETN-16	16-290- DWETN-17	16-290- DWETN-18	16-290- DWETN64	16-290- DWETN60	16-290- DWETN2746
Ø130	70,70	73,02	75,34	231,80	120,54	151,83
Ø150	76,49	78,81	82,29	249,19	129,81	165,74
Ø180	88,08	90,40	97,36	257,30	159,94	183,12
Ø200	90,40	95,04	100,83	162,26	169,21	301,34

*Po naročilu

TROSLOJNI DIMNIKI DW-BLACK (25mm izolacije)



DIMNIŠKI ZAKLJUČKI	Zaključna kapa (do 450°C/N1)	Protivetrni zaključek-vrtljiva vratca	Univerzalni zaključek za EW in DW	Protidežna kapa	Pritrdilna rozeta	Pritrdilna rozeta s prirobnico
	16-205-DWETN32	16-205-DWETN92HS	16HUB01E *	16-215-DWECO33	16-215-DWECO31	16-215-DWECO307 *
Ø130	57,95	171,53	206,30	54,47	12,75	18,54
Ø150	61,43	191,24	219,05	60,27	13,91	19,70
Ø180	69,54	212,10	235,28	68,38	16,23	23,18
Ø200	75,34	236,44	245,71	73,02	17,39	24,34



ZIDNA DRŽALA	Zidno držalo fiksno, 50 mm	Zidno držalo nastavljivo, 50-150 mm	Zidno držalo nastavljivo, 50-250 mm	Zidno držalo nastavljivo, 250-360 mm	Zidno držalo (sleeve/holder) 360 mm	Podaljšek držala 30 x 30 mm za DWECO 20	
	16-DWECO 21	16-DWECO 22 *	16-DWECO 23 *	16-DWECO 24 *	16-DWECO 20 *	16-DW86 *	16-DW85 *
						L=1000 mm	L=500 mm
Ø130	47,52	112,42	117,06	143,72	126,33	59,11	33,61
Ø150	48,68	113,58	118,22	144,88	127,49		
Ø180	51,00	114,74	119,38	146,03	128,65		
Ø200	53,31	119,38	122,85	149,51	132,13		



PRITRDILNI KOSI	Zunanja zaklepna objemka 2.0	Objemka 3 vijaki	Objemka 2 vijaka	Nastavljivi stropni nosilec 500-900mm	Sidrne cevi nastavljive do 2 m	Sidrne cevi nastavljive do 3 m	Sidrne cevi nastavljive do 4 m
	16-DWECO 989	16-DWECO 42 *	16-2R2-ZUAC989 *	16-DWECO 55 *	ZUDA 904-2000 *	ZUDA 904-3000 *	ZUDA 904-4000 *
Ø130	27,82	34,77	51,00	150,67	244,55	279,32	385,95
Ø150	28,98	34,77	52,16	154,15			
Ø180	32,45	38,25	56,79	155,31			
Ø200	35,93	38,25	57,95	173,85			

*Po naročilu

PVC CEVI ZA PLINSKE KONDENZACIJSKE PEČI EW-PPS



CEVI ČISTILNI ELEMENTI	Cev 2000 mm	Cev 1000 mm	Cev 500 mm	Cev 250 mm	Cev s čistilno odprtino	Cev z odvodom kondenza in sifonom
Koda	130-PP339	130-PP02	130-PP03	130-PP04	130-PP30	130-PP111
Ø060	23,22	14,36	10,32	7,54	20,90	43,44
Ø080	32,48	18,26	12,01	8,86	26,43	39,16
Ø100 *	50,98	29,76	20,90	15,25	36,96	55,51
Ø110 *	73,54	47,71	27,32	21,70	60,18	89,71
Ø125 *	96,27	60,38	40,88	29,27	93,55	97,85
Ø160 *	127,29	81,77	55,51	45,61	162,99	133,54
Ø200 *	204,07	120,90	93,15	55,51	146,88	184,49
Ø250 *	316,57	221,99	146,88	120,90	316,57	279,16



KOLENA	Koleno 30°	Koleno 45°	Koleno 87°	Koleno 87° s podporo	Koleno s čistilno odprtino	Zaključek dimnika PP
Koda	130-PP18	130-PP19	130-PP22	130-PP06	130-PP23	130-PP837
Ø060	10,32	10,32	11,61	33,57	20,90	76,12
Ø080	12,64	12,64	15,11	54,19	28,84	75,06
Ø100 *	29,01	18,49	23,02	71,62	40,40	
Ø110 *	32,34	32,34	34,55	91,34	80,82	
Ø125 *	49,03	49,03	50,55	133,54	127,52	
Ø160 *	92,00	92,00	92,00	184,49	155,96	
Ø200 *	146,88	146,88	166,49	204,07	184,49	
Ø250 *	221,99	241,49	316,57	429,22	354,22	



ZAKLJUČNI ELEMENTI	Distančnik	Rozeta	Zaključek dimnika z rozeto in cevjo Inox *odprodaja	Razširitveni kos 130-PPE.....				
Koda	130-PP40	FU72	PP342	Ø60	Ø80	Ø100	Ø110	Ø125
Ø060	12,73	23,90	58,76					
Ø080	11,27	23,90	61,48	28,84				
Ø100 *		27,25			36,96			
Ø110 *		27,25			61,30	58,49		
Ø125 *		27,25			148,63	83,03	122,36	
Ø160 *		31,17				94,64		91,34
Ø200 *		35,59						
Ø250 *		40,19						

*Po naročilu

PVC CEVI ZA PLINSKE KONDENZACIJSKE PEČI EW-PPS



REDUCIRNI ELEMENTI	Reducirni kos ekscentričen					Reducirni kos					
	130-PPE.....EX					130-PPR.....					
Koda	Ø60	Ø80	Ø100	Ø110	Ø160	Ø80	Ø100	Ø110	Ø125	Ø160	Ø200
Ø060						31,19					
Ø080	39,31						31,19	31,19			
Ø100 *		47,36						36,96	76,12		
Ø110 *		80,22	80,22						91,34		
Ø125 *			83,03	57,23						91,34	
Ø160 *			166,49								184,49
Ø200 *					109,43						
Ø250 *											

FLEKSIBILNE PVC CEVI ZA PLINSKE KONDENZACIJSKE PEČI EW-PP-FLEX



Naziv	Cev fleksibilna	Cev z revizijsko odprtino	Adapter za flex cev	Montažni set 1	Montažni set 2
Koda	PPFLEX02	PPFLEX30	PPFLEX07	PPFLEX09	PPFLEX804
Ø060	23,14	85,64	46,24		40,88
Ø080	26,12	111,99	69,24	19,98	43,44
Ø100 *	45,64	136,13	92,23		49,03
Ø110 *		143,44	100,66		63,91
Ø125 *	88,10	277,41	156,80		184,49
Ø160 *	121,93	315,03	182,86		221,99

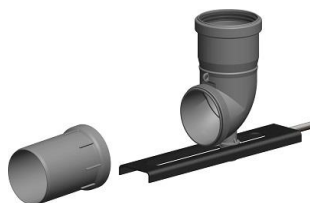

Naziv	Distančnik - 4 kosi	Koleno z snemljivim priključkom in podporo
Koda	PPFLEX41	130-PP1234
Ø060		69,93
Ø080		76,12
Ø100	11,61	
Ø110	11,61	

*Po naročilu

KOAKSIALNI DIMNIKI ZA PLINSKE KONDENZACIJSKE PEČI TWIN-PL



Naziv	Cev 1000 mm	Cev 500 mm	Cev 250 mm	Cev s čistilno odprtino	Cev z merilno odprtino
Koda	TWPL13	TWPL14	TWPL15	TWPL10	TWPL51
ø060/100	47,36	30,07	23,65	90,31	68,84
ø080/125	49,46	32,34	25,80	94,64	71,02
ø100/150 *	58,11	34,35	34,35	118,32	92,49
ø110/160 *	71,02	43,06	34,35	141,89	111,84



Naziv	Koleno 30°	Koleno 45°	Koleno 87°	Koleno 87° s čistilno odprtino	T kos 87° z revizijo in priključkom na kotel
Koda	TWPL17	TWPL18	TWPL64	TWPL67	TWPL308
ø060/100	45,18	32,34	66,72	133,40	98,88
ø080/125	49,46	45,18	71,02	141,89	101,12
ø100/150 *	71,02	58,11	77,44	157,00	129,04
ø110/160 *	51,63	64,48	83,86	172,02	150,55



Naziv	Rozeta	Zaključek dimnika črn	Zunanje tesnilo	Strešna obroba 0-48°
Koda	TWL31	TWPL1944	TW26	TWPL354
ø060/100	32,34	152,78		208,63
ø080/125	34,35	159,12	23,65	208,63
ø100/150 *	34,35			
ø110/160 *	36,58			

ČRNI DIMNIKI ZA KAMINE IN KAMINSKE PEČI FERRO



CEVI	Cev 1000mm		Cev 500mm		Cev 250mm		Cev z revizijo in loputo 500mm		Cev z loputo 500mm		Dimniški radiator (po naročilu)		Zidni vložek 100mm	
	FERRO	1401 črna	3401 siva	1403 črna	3403 siva	1405 črna	3405 siva	1451 črna	3451 siva	1418 črna	3418 siva	1102 črn	1413 črna	3413 siva
Ø120	56,31	56,31	29,44	29,44	17,24	17,24	68,59	68,59	49,14	49,14			18,59	
Ø130	58,77	58,77	31,93	31,93	19,65	19,65	68,59	68,59	51,44	51,44				
Ø150	68,59	68,59	39,24	39,24	22,14	22,14	71,00	71,00	53,93	53,93	71,00		18,59	18,59
Ø160	76,92	76,92	41,75	41,75	24,49	24,49	80,91	80,91	58,77	58,77			26,51	
Ø180	84,00	84,00	46,51	46,51	26,98	26,98	83,56	83,56	68,59	68,59			29,14	31,74
Ø200	92,67	92,67	55,37	55,37	31,93	31,93	99,61	99,61	75,95	75,95			31,74	



KOLENA	Koleno 45°		Koleno 90°		Koleno 90° z vratci čistilno		Koleno 0- 90° gibljivo		Koleno 0-90° gibljivo z revizijo		Rozeta 55mm		Rozeta 85mm	
	FERRO	1410 črna	3410 siva	1454 črna	3454 siva	1407 črna	3407 siva	1101 črna	3101 siva	1431 črna	3431 siva	1422 črna	3422 siva	1423 črna
Ø120	53,24	53,24	61,84	61,84	55,73	55,73	60,04		61,84	61,84	9,32	9,32	16,30	16,30
Ø130	53,24	53,24	66,99	66,99	60,38	60,38			66,99	66,99	9,32	9,32	18,59	18,59
Ø150	57,97	57,97	77,31	77,31	69,51	69,51	71,55	75,12	77,31	77,31	11,57	11,57	25,54	25,54
Ø160	64,97	64,97	87,57	87,57	78,86	78,86	74,13		87,57	87,57	14,00	14,00	30,13	30,13
Ø180	74,18	74,18	95,32	95,32	85,78	85,78	82,12	94,49	95,32	95,32	14,00	14,00	30,13	30,13
Ø200	85,78	85,78	113,25	113,25	102,05	102,05	92,72		113,25	113,25	16,30	16,30	34,75	34,75



RAZŠIRITVENI KOSI	DN120		DN130	DN150	DN160	DN180	REDUCIRNI KOSI	DN130	DN150	DN160	DN180	DN200	
	FERRO-	E1110 črna	E1120 črna	E3120 siva	E1130 črna	E1150 črna		E1160 črna	E1180 črna	FERRO-	R1130 črna	R1150 črna	R1160 črna
Ø120	33,59							Ø120	39,46	45,16			
Ø130		39,46						Ø130		45,16		40,87	
Ø150	58,27	42,11	68,81	42,11				Ø150		46,29	60,26	71,00	
Ø160		42,11		44,11				Ø160			60,26	71,00	
Ø180		68,81		71,55	42,25	42,25		Ø180				71,89	
Ø200		71,55		74,13	43,75	43,75	56,67	Ø200					

ČRNI DIMNIKI ZA PELETNE KAMINE EWEC.



CEVI	Cev za peletne kamine 1000mm	Cev za peletne kamine 500mm	Cev za peletne kamine 250mm	Cev za peletne kamine z revizijo 500mm	Objemka	Rozeta
Koda	6C15AL.013	6C15AL.014	6C15AL.015	6C15AL.725	4C1500.045	15-ZUWA676
ø80	60,87	39,88	32,38	72,29	19,05	26,63
ø100	64,68	47,51	38,02	79,92	19,05	26,63



PRIKLJUČNI KOSI	Koleno 90°	Koleno 90° z revizijo	Koleno 45°	T-kos za peletne kamine s kondenzno posodo
Koda	6C15AL.060	6C15AL.019	6C15AL.018	6C15AL.557
ø80	51,35	83,70	36,19	91,34
ø100	55,12	87,59	36,19	95,17



VENTILATOR DIMNIH PLINOV MF8701A

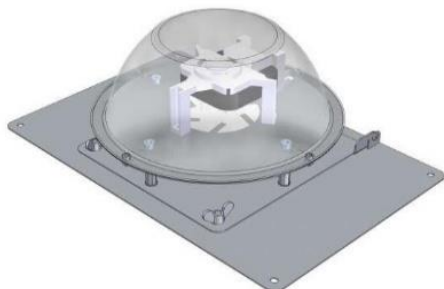

Koda	Naziv	Cena
MF8701A	Ventilator dimnih plinov za oglate dimnike (zunanja mera)	268,40

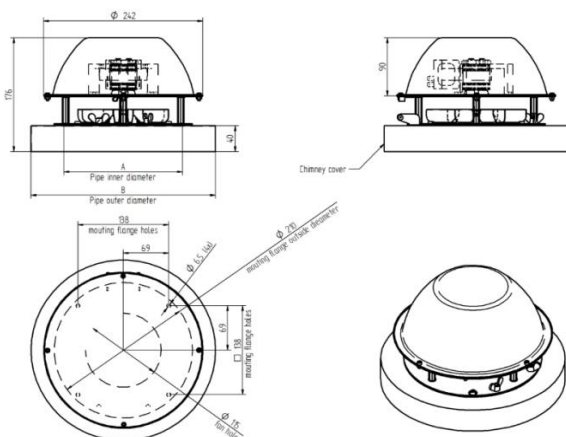

VENTILATOR DIMNIH PLINOV MF8702A

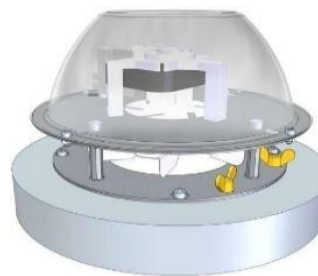

Koda	Naziv	Cena
MF8702A	Ventilator dimnih plinov za okrogle dimnike (zunanji premer)	268,40

Dimniški ventilator je namenjen odvodu dimnih plinov iz kurilnih naprav do 50 kW na trda goriva, kjer dimovodna naprava sama ne zagotavlja zadostnega vleka za optimalno delovanje, ali če je optimalno delovanje dimovodne naprave moteno zaradi vetra ali drugih naravnih pogojev. Delovanje ventilatorja poveča in ustvari potreben vlek dimnika za optimalno delovanje kurilne naprave in optimizira razmerje ogljikovega monoksida in kisika. Montira se na ustje nerjavnega dimnika. Sestavljen je iz osnovne plošče, ki se pritrdi na obstoječi dimnik ter zgornje plošče z ventilatorjem in kapo, ki se lahko z odvitjem dveh krilnih vijakov kipoma odstrani ter tako omogoča čiščenje dimnika. Maksimalna dovoljena temperatura dimnih plinov je na ustju dimnika 250°C, dimniški ventilator ustreza dimenzijam dimnikov do velikosti 120x240 mm za oglate dimnike in od fi 130-280 mm za okrogle dimnike.

Model	MF9701A	MF8702A
Motor		32W, 0,27A
Dimenzije	374 x 244 x 136mm	280 x 242 x 136
Dimenzije dimnika za montažo	130-230mm, 150-250mm, 180-280mm	
Napajanje UV in vodoodporen kabel	3g 0,75 5m	
Teža	3,6 kg	2,9 kg
Max. ustvarjen tlak	110 Pa	
Pretok	360 m ³ /h	
Glasnost	52 dB	
Temperaturno območje delovanja	40 - 70°C	

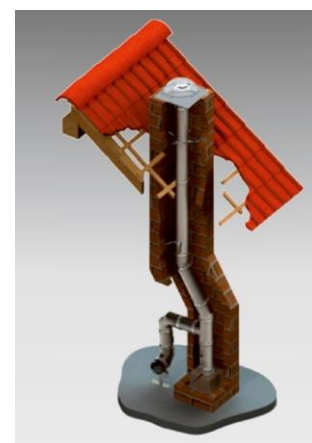

REGULATOR VENTILATORJA S TIPALOM DIMNIH PLINOV



Koda	Naziv	Cena
BS-844/2	Regulator obratov za ventilator dimnih plinov s tipalom	96,38
A-844/2	Tipalo dimnih plinov do 450°C	29,95



čiščenje kotlov, kaminov in dimnikov



Cenik velja od 1.11.2022. Cene vsebujejo 22% DDV. komerciala@pilremag.si www.pilremag.si Tel.: +386 - 1 - 786 - 39 - 83 Trgovina: 059 - 11 - 2000

ČISTILNI PRIBOR ZA PEČI, KAMINE IN DIMNIKE

7005	7000	7001	7002	7003	7004	Vedro10 Vedro12 Vedro15	4779022361098
Komplet za čiščenje	Lopata	Grebljica	Krtača	Kljuka	Nosilec pribora za čiščenje	Vedro za pepel 10/12/15 litrov	Negorljive rokavice par
14,64	4,27	3,05	6,10	3,05	2,44	7,32 8,54 9,76	35,38

4779022360596	4779022361012	4779022360558	4779022360619	4779022360565
Rotacijska fleksibilna cev za čiščenje Tornado (cev 6m)	Palica za čiščenje (za univerzalno ščetko) 6 x 1m	Univerzalna ščetka ø400mm za čiščenje dimnika	Dimne kapsule za kontrolo vleka	Kaminski termometer magnetni
231,80	38,92	18,18	12,20	15,74

4779022360237	4779022361326	4779022360176	4779022360220	4779022360572	4779022360183
Odstranjevalec saj briket 1,1kg	Odstranjevalec saj v vrečkah 5 x 18g za kamine 7-14kW	Odstranjevalec saj v vrečkah 0,5kg (10 x 50g)	Briketi za vžig 32 kosov	Koncentrirani odstranjevalec saj v prahu 0,5kg	Koncentrirani odstranjevalec saj v prahu 1kg
13,66	6,66	11,96	1,88	7,08	15,25

4779022360169	4779022360626	4779022360411	4779022361739	4779022360275	4779022360114	4779022360145	4779022360138
Čistilna pena 500ml za kaminsko steklo	Čistilna pena Eco 500ml za kaminsko steklo	Goba za suho in mokro čiščenje kaminskega stekla	Barva v spreju do 800°C 400ml bela 990	Barva v spreju do 800°C 400ml siva 970	Barva v spreju do 800°C 400ml antracit 930	Barva v spreju do 800°C 400ml dark antracit 937	Barva v spreju do 800°C 400ml črna 910
10,25	13,66	5,98	13,42	13,42	13,42	13,42	13,42

4779022360480	4779022360459	4779022360466	4779022360473	4779022360695	4779022360510	477922360640	4779022360930
Samolepilna tesnilna vrstica 10 x 2 mm	Tesnilna vrstica 6 mm do 850°C	Tesnilna vrstica 8 mm do 850°C	Tesnilna vrstica 10 mm do 850°C	Tesnilna vrstica 12 mm do 850°C	Lepilo za tesnilno vrstico do 1200°C 17 ml	Usnjena košara za drva 35 x 35 x 50cm	Nylon košara za drva 46 x 25 x 24cm
20,98	10,49	13,91	17,32	22,94	12,20	195,08	17,08

ELEKTRIČNI KOTEL stenski

Koda	Naziv	Cena
ECO-08MRT	Električni kotel 08MRT stenski	839,36
ECO-12MRT	Električni kotel 12MRT stenski	844,24



NOVO

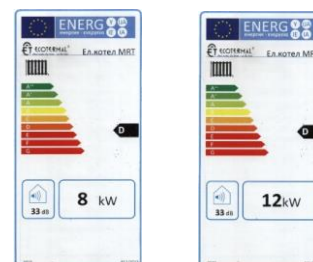

Pretočni električni kotel ECOTERMAL je sodoben ekološki vir toplote, namenjen za etažno in centralno ogrevanje manjših in srednje velikih objektov. Glavne prednosti ogrevanja z električno energijo so predvsem **stroškovna učinkovitost, visok izkoristek, prijaznost do okolja in zanesljivost.**

Električni kotel se lahko uporablja v vsakem sistemu centralnega ali etažnega (lokalnega) ogrevanja v direktnem, akumulacijskem ali hibridnem sistemu.

Možno ga je vgraditi tudi v obstoječe ogrevalne sisteme vzporedno s kotlom na trda goriva ali toplotno črpalko. Pri odprtem sistemu deluje do temperature 95°C max., pri zaprtem sistem do 110°C pri tlaku 1,8 bar v samostojnem ogrevalnem krogu.

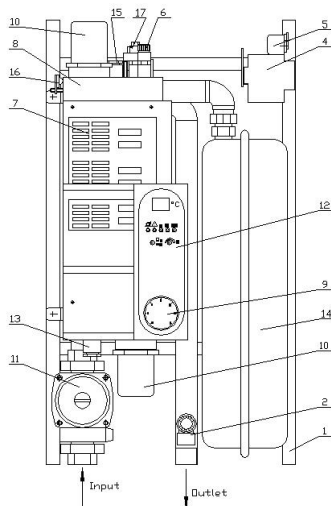

SESTAVA ELEKTRIČNEGA KOTLA

1. Okvir
2. Varnostni ventil 2,5 bar
4. Avtomatske varovalke
5. Zasilni (blokirni) termostat
6. Odzračevalni lonček
7. Regulacija
8. Izmenjevalec
9. Manometer
10. Grelniki
11. Obtočna črpalka
12. Nadzorna plošča
13. Ventil za manometer
14. Raztezna posoda
15. Prostor za termostat
16. Termostat – bimetalni
17. Tlačno stikalo

TEHNIČNE LASTNOSTI

Model		ECO-08MRT	ECO-12MRT
Moč	kW	8	12
Dimenzije			
Višina	mm	700	700
Širina	mm	385	385
Globina	mm	260	260
Teža	kg	29,0	29,0
Tehnične značilnosti			
Stopnje modulacije		3	3
Volumen izmenjevalca kotlov	dm ³	8,9	8,9
Napajanje	V	240 / 400	240 / 400
Tehnični podatki			
Grelec	(A)	11,11	16,67
Prečni presek napajalnih kablov	[mm ²]	5 x 2,5	(3 x 4 + 2,5) + 1 x 4
Varovalka	(A)	16	25
Največji delovni tlak	Bar	2,50	2,50
Testni tlak	Bar	4,00	4,00
Regulacija temp. toplotnega medija	°C	30 - 90	30 - 90
Nadzor sobne temperature	°C	5 - 30	5 - 30
Dimenzije priključnih cevi		1"	1"
Indeks učinkovitosti	%	99,30	99,30
Oprema kotlov			
Raztezna posoda		da	da
Obtočna črpalka		da	da
Varnostni ventil		da	da
Varnostno stikalo		da	da
Termostat		da	da
Odzračevalni lonček		da	da
Montažni nosilci		da	da

TOPLOTNA ČRPALKA monoblock z inverternim modulom PRIMA 6-16GT

Koda	EAN	Naziv	Cena
09-400600		PRIMA 6GT - monoblock toplotna črpalka inverter	4.867,80
09-400800		PRIMA 8GT - monoblock toplotna črpalka inverter	5.477,80
09-401000		PRIMA 10GT - monoblock toplotna črpalka inverter	6.051,20
09-401210		PRIMA 3F 12GT - monoblock toplotna črpalka inverter	7.015,00
09-401610		PRIMA 3F 16GT - monoblock toplotna črpalka inverter	7.535,21

3 funkcije v 1 napravi -
ogrevanje, hlajenje
in sanitarna voda

Najvišji razred energetske
učinkovitosti

Spletni nadzor prek
aplikacije - priloženo

Tiho delovanje

Ekološko hladilno sredstvo

Garancija: 5 let



Tehnične lastnosti			PRIMA 6GT	PRIMA 8GT	PRIMA 10GT	PRIMA 3F 12GT	PRIMA 3F 16GT
Grelna moč	enota	kW	6,35	8,40	10,00	12,10	12,10
Priključna moč	ogrevalni način (A7W35)	kW	1,28	1,63	2,02	2,44	3,53
Koeficient učinkovitosti - COP			4,95	5,15	4,95	4,95	4,50
Grelna moč	ogrevalni način (A7W35)	kW	6,00	7,50	9,50	11,90	16,00
Priključna moč	ogrevalni način (A7W35)	kW	2,03	2,36	3,06	3,90	5,61
Koeficient učinkovitosti - COP			2,95	3,18	3,10	3,05	2,85
Hladilna moč	hladilni način (A7W35)	kW	7,00	7,45	8,20	11,50	14,00
Priključna moč	hladilni način (A7W35)	kW	2,33	2,22	2,52	4,18	5,60
EER			3,00	3,35	3,25	2,75	2,50
ErP razred energetske učinkovitosti	W35						A+++
	W55						A++
Razpon regulacije grelne moči (min/max) A7W35	kW		2,73 / 7,41	3,36 / 9,11	3,81 / 10,03	5,58 / 14,60	6,43 / 16,80
Moč dodatnega električnega grelca	kW		3	3	3	9	9
Zvočna moč	dB		58	59	60	65	68
Zvočni tlak na razdalji 3m	dB		40	41	42	45	48
Kompresor			dvojni rotacijski				
Ventilator			DC				
Toplotni izmenjevalnik (uparjalnik)			lamelni				
Hladilno sredstvo			R32 1,4kg	R32 1,4kg	R32 1,4kg	R32 1,75kg	R32 1,75kg
Dimenzije (v x š x g)	mm		792x1295x429	945x1385x526	945x1385x526	945x1385x526	945x1385x526
Dimenzije paketa (v x š x g)	mm		945x1375x475	1120x1465x560	1120x1465x560	1120x1465x560	1120x1465x560
Neto/bruto teža	kg		103 / 126	126 / 153	126 / 153	165 / 193	165 / 193
Območje delovanja (zunanja temperatura)	hlajenje	°C	-5 ~ 43				
	ogrevanje	°C	-25 ~ 35				
	sanitarna voda	°C	-25 ~ 43				
Toplotni izmenjevalnik (uparjalnik)			tip plošče				
Priključki			1	5/4	5/4	5/4	5/4
Temperaturno območje vode	hlajenje	°C	5 ~ 30				
	ogrevanje	°C	12 ~ 65				
	sanitarna voda	°C	10 ~ 60				
Napetost in frekvenca	V / Hz		220-240 / 50	220-240 / 50	220-240 / 50	280-415 / 50	280-415 / 50

Skladno s standardom EN 14511 A - temperatura zraka; W -
temperaturno območje ogrevane vode

Skladno s standardom EN 12102

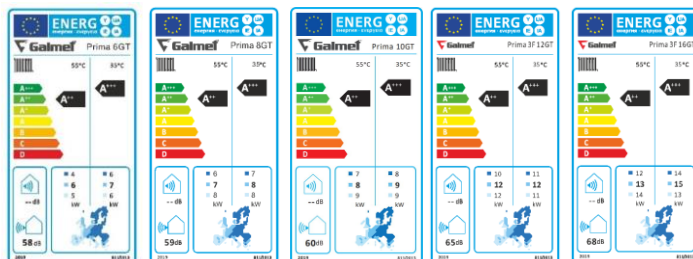

TOPLOTNA ČRPALKA split inverter PRIMA S 6-16GT

Koda	EAN	Naziv	Cena
09-410600		PRIMA S 6GT - toplotna črpalka split inverter	5.439,98
09-410800		PRIMA S 8GT - toplotna črpalka split inverter	6.140,26
09-411000		PRIMA S 10GT - toplotna črpalka split inverter	6.140,26
09-411210		PRIMA S 3F 12GT - toplotna črpalka split inverter	7.340,74
09-411610		PRIMA S 3F 16GT - toplotna črpalka split inverter	7.840,94

3 funkcije v 1 napravi - ogrevanje, hlajenje in sanitarna voda

Najvišji razred energetske učinkovitosti

Spletni nadzor prek aplikacije - priloženo

Tiho delovanje

Ekološko hladilno sredstvo

Garancija: 5 let



Tehnične lastnosti		enota	PRIMA S 6GT	PRIMA S 8GT	PRIMA S 10GT	PRIMA S 3F 12GT	PRIMA S 3F 16GT
Zunanja enota			ODU Prima S 6GT	ODU Prima S 8GT	ODU Prima S 10GT	ODU Prima S 12GT	ODU Prima S 16GT
Notranja enota			IDU Prima S 6GT	IDU Prima S 8GT	IDU Prima S 10GT	IDU Prima S 12GT	IDU Prima S 16GT
Grelna moč	ogrevalni način	kW	6,20	8,30	10,00	12,10	16,00
Priključna moč	(A7W35)	kW	1,24	1,60	2,00	2,44	3,56
Koeficient učinkovitosti - COP			5,00	5,20	5,00	4,95	4,50
Grelna moč	ogrevalni način	kW	6,00	7,50	9,50	12,00	16,00
Priključna moč	(A7W35)	kW	2,00	2,36	3,06	3,87	5,52
Koeficient učinkovitosti - COP			3,00	3,18	3,10	3,10	2,90
Hladilna moč	hladilni način	kW	7,00	7,40	8,20	11,60	14,00
Priključna moč	(A7W35)	kW	2,33	2,19	2,48	4,22	5,71
EER			3,00	3,38	3,30	2,75	2,45
ErP razred energetske učinkovitosti	W35				A+++		
	W55				A++		
Nazivni pretok vode		m ³ /h	1,07	1,43	1,72	2,08	2,75
Kompresor			dvojni rotacijski				
Ventilator			DC				
Toplotni izmenjevalnik (uparjalnik)			lamelni				
Hladilno sredstvo			R32 1,5kg	R32 1,65kg	R32 1,65kg	R32 1,84kg	R32 1,84kg
	vrsta priključka	mm	navojni priključek				
	tekočina (ø)	mm	6,35	9,52	9,52	9,52	9,52
	plin (ø)	m	15,9				
	min. dolžina	m	2				
	max. dolžina	m	30				
Dovoljena razlika v viš. namestitve enot		m	20				
Zvočna moč (nivo hrupa) zunanje enote		dB	58	59	60	64	68
Zvočni tlak zunanje enote		dB	38	39	40	44	48
Zvočna moč (nivo hrupa) notranje enote		dB	38	42	42	43	43
Dimenzije zunanje enote (v x š x g)		mm	712x1008x426	865x1118x523	865x1118x523	865x1118x523	865x1118x523
Dimenzije notranje enote (v x š x g)		mm	790x420x270	790x420x270	790x420x270	790x420x270	790x420x270
Dimenzije paketa zunanje enote (v x š x g)		mm	800x1065x485	890x1180x560	890x1180x560	890x1180x560	890x1180x560
Dimenzije paketa notranje enote (v x š x g)		mm	1050x525x360	1050x525x360	1050x525x360	1050x525x360	1050x525x360
Neto/bruto teža zunanje enote		kg	60 / 65,5	78,5 / 92	78,5 / 92	116 / 129,5	116 / 129,5
Neto/bruto teža notranje enote		kg	43 / 49	43 / 49	43 / 49	45 / 51	45 / 51
Razpon regulacije grelne moči (min/max) A7W35		kW	2,7 / 7,4	3,4 / 9,1	3,8 / 10,3	5,6 / 14,6	6,4 / 16,8
Moč dodatnega električnega grelca		kW	3	3	3	9	9
Priključki notranje enote		*	1	1	1	1	1
	hlajenje	°C	-5 ~ 43				
	ogrevanje	°C	-25 ~ 35				
	sanitarna voda	°C	-25 ~ 43				
Toplotni izmenjevalnik (uparjalnik)			lamelni				
	hlajenje	°C	5 ~ 25				
	ogrevanje	°C	25 ~ 65				
	sanitarna voda	°C	30 ~ 60				
Temperaturno območje vode							
	zunanja enota	V / Hz	220-240 / 50	220-240 / 50	220-240 / 50	380-415 / 50	380-415 / 50
	notranja enota	V / Hz	220-240 / 50	220-240 / 50	220-240 / 50	380-415 / 50	380-415 / 50

Skladno s standardom EN 14511 A - temperatura zraka; W - temperaturno območje ogrevane vode

Skladno s standardom EN 12102

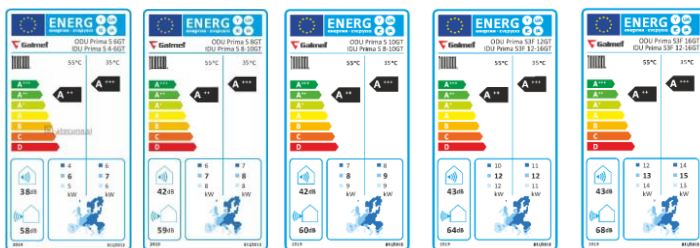

TOPLOTNA ČRPALKA ZA OGREVANJE SPLIT DC INVERTER

Koda	EAN	Naziv	Cena
MIDEA6SPLIT		Midea S 6kW - toplotna črpalka, split inverter Zunanja + notranja enota	5.439,98
MIDEA8SPLIT		Midea S 8kW - toplotna črpalka, split inverter Zunanja + notranja enota	6.140,26
MIDEA3F12SPLIT		Midea S 3F 12kW - toplotna črpalka, split inverter Zunanja + notranja enota	7.340,74
MIDEA3F14SPLIT		Midea S 3F 14kW - toplotna črpalka, split inverter Zunanja + notranja enota	7.540,82
MIDEA3F16SPLIT		Midea S 3F 16kW - toplotna črpalka, split inverter Zunanja + notranja enota	7.840,94
MIDEA3F30MONO		Midea 30kW - toplotna črpalka, monoblock inverter Zunanja + notranja enota	10.790,90

GARANCIJA:
2eti + 3 leta po servisni shemi proizvajalca

MIDEA
toplotni izmenjevalec

MITSUBISHI
kompresor twin - rotary

ELEKTRONSKA
obtočna črpalka



SPLIT INVERTER ZUNANJA ENOTA



NOTRANJA ENOTA



MONOBLOCK DC INVERTER 30kW

Tehnične lastnosti		SPLIT DC INVERTER					MONO DC INVERTER
MODEL	enota	MHA-V 6W/HB-A60	MHA-V 8W/HB-A100	MHA-V 12W/HB-A160	MHA-V 14W/HB-A160	MHA-V 16W/HB-A160	MHC-V 30W D2RN8
Električni prikllop	V/Hz/Ph	220/50/1	220/50/1	380/50/3	380/50/3	380/50/3	380/50/3
Električni tok	A	16	20	12	12	12	12
Tip hladiva		R 32	R 32	R 32	R 32	R 32	R 32
Grelna moč	kW	6	8	12	14	16	30
COP + 2 - 35 - 7 - 55° C energetski certifikat	A+++/A++	5,01	5,21	4,95	4,71	4,51	3,99
Temperatura sistemske vode max	°C	65	65	65	65	65	60
Temperatura san. vode min - max - nastavljivo	°C	30 - 60	30 - 60	30 - 60	30 - 60	30 - 60	30 - 60
Minimalna zunanja temperatura	°C	-25	-25	-25	-25	-25	-25
WI FI krmiljenje	vgrajeno	155,73	155,73	155,73	155,73	155,73	155,73
Notranja enota							
Tipalo za sanitarni. Vodo		DA	DA	DA	DA	DA	DA
Dimenzije notranje enote Š x V x G	mm	42 x 79 x 27	42 x 79 x 27	42 x 79 x 27	42 x 79 x 27	42 x 79 x 27	
Teža notranje enote	kg	37	37	39	39	39	
Zunanja enota							
Število kompresorjev		1	1	1	1	1	1
Št. ventilatorjev		1	1	1	1	1	2
Dimenzije zunanje enote Š x V x G	mm	100 x 72 x 43	112 x 86 x 53	112 x 86 x 53	112 x 86 x 53	112 x 86 x 53	113 x 156 x 54
Teža zunanje enote	kg	58	77	112	112	114	178

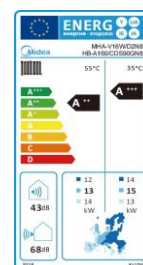
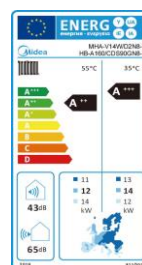
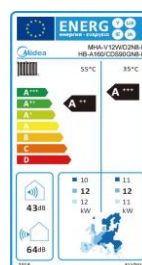
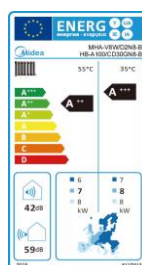
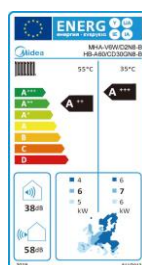
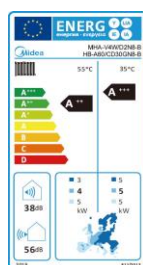

TOPLOTNA ČRPALKA ZA OGREVANJE SPLIT DC INVERTER z bojlerjem

Koda	EAN	Naziv	Cena
MIDEA6W190SPLIT		Midea S 6kW - toplotna črpalka, split inverter z integriranim bojlerjem 190L	7.890,96
MIDEA8W190SPLIT		Midea S 8kW - toplotna črpalka, split inverter z integriranim bojlerjem 190L	8.091,04
MIDEA3F12W240SPLIT		Midea S 3F 12kW - toplotna črpalka, split inverter z integriranim bojlerjem 240L	9.190,26
MIDEA3F14W240SPLIT		Midea S 3F 14kW - toplotna črpalka, split inverter z integriranim bojlerjem 240L	6.750,26
MIDEA3F16W240SPLIT		Midea S 3F 16kW - toplotna črpalka, split inverter z integriranim bojlerjem 240L	9.490,38

GARANCIJA:

2 leti + 3 leta kompresor
po servisni shemi proizvajalca

MIDEA

toplotni izmenjevalec

MITSUBISHI

kompresor twin - rotary

ELEKTRONSKA

obtočna črpalka



Tehnične lastnosti		SPLIT DC INVERTER					
MODEL	enota	MHA-V4W/190	MHA-V6W/190	MHA-V8W/190	MHA-V12W/240	MHA-V14W/240	MHA-V16W/240
Električni priključek	V/Hz/Ph	220/50/1	220/50/1	220/50/1	380/50/3	380/50/3	380/50/3
Električni tok	A	16	16	20	16	16	16
Tip hladiva		R 32	R 32	R 32	R 32	R 32	R 32
Grelna moč	kW	6	6	8	12	14	16
COP + 2 - 35 - 7 - 55°C energetski certifikat	A+++/A++	5,01	5,01	5,21	4,95	4,71	4,51
Temperatura sistemske vode do	°C	65	65	65	65	65	65
Temperatura san. vode min - max - nastavljivo	°C	30 - 60	30 - 60	30 - 60	30 - 60	30 - 60	30 - 60
Minimalna zunanja temperatura	°C	-25	-25	-25	-25	-25	-25
Notranja enota z bojlerjem 190 ali 240 l		190 l	190 l	190 l	240 l	240 l	240 l
Možnost cirkulacije		DA	DA	DA	DA	DA	DA
Dimenzije notranje enote Š x V x G	cm	60 x 60 x 168	0	0	60 x 60 x 194	0	0
Teža notranje enote	kg	135	135	135	165	165	165
Zunanja enota							
Število kompresorjev		1	1	1	1	1	1
Št. ventilatorjev		1	1	1	1	1	1
Dimenzije zunanje enote Š x V x G	cm	100 x 72 x 43	100 x 72 x 43	112 x 86 x 53	112 x 86 x 53	112 x 86 x 53	112 x 86 x 53
Teža zunanje enote	kg	58	58	77	112	112	114

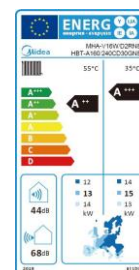
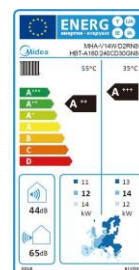
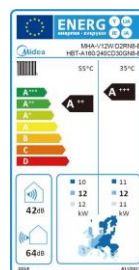
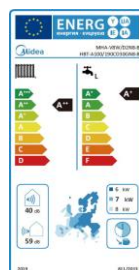
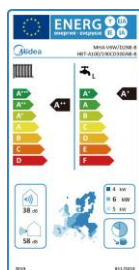
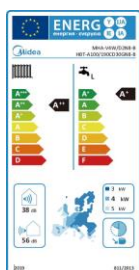

TOPLOTNA ČRPALKA ZRAK / VODA HOTJET ONE 2(i) - inverter

Koda	Naziv	Moč (kW)	Cena
HJ07ZETXe	Hotjet 7 ONE2(i)	A7/W35 za 60Hz : 6,00 / 4,8	8.552,20
EKOJ10ZETXe	Hotjet 10 ONE2(i)	A7/W35 za 60Hz : 7,98 / 4,72	9.052,40
EKOJ20ZETXe	Hotjet 20 ONE2(i)	A7/W35 za 60Hz : 12,00 / 4,9	10.321,20



Ogrevanje (do 60°C), hlajenje (hladilno sredstvo R454B (GWP 466) podobni parametri kot R410A), inverter Copeland Scroll YHB, el. omarica s Siemens regulacijo RVS, sobna / kontrolna enota QAA75, EC ventilator, Danfoss sofstarter

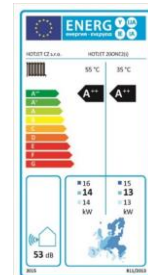
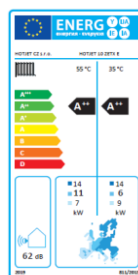

Tehnični podatki		HJ07 ZETXe	EKOJ10 ZETXe	EKOJ20 ZETXe
Podatki o učinkovitosti	enota	Moč ogrevanja [kW] / Poraba energije [kW] / Faktor ogrevanja [COP]		
Nazivna moč (min. / max.) kW	6,0	6,0 (0,9-8,0)	8,0 (2,0-10,7)	10,0 (3,0-14,5)
Nazivna moč / COP za A7/W35 1) - za 60Hz	kW / -	6,00 / 4,8	7,98 / 4,72	12,00 / 4,9
Nazivna moč / COP za A2/W35 1) - za 60Hz	kW / -	4,10 / 3,40	5,65 / 3,60	8,60 / 3,60
Nazivna moč / COP za A-7/W35 1) - za 60Hz	kW / -	3,82 / 3,55	7,63 / 2,48	7,85 / 3,57
Nazivna hladilna zmogljivost za kompresor (za 60Hz)	kW	5,0 (1,1-8,9)	6,0 (3,3-11,9)	11,0 (5,5-14,0)
Razred energijske učinkovitosti 4)		A++/ A++	A++/ A++	A++/ A++
Tehnične lastnosti				
Izvedba			Monoblok	
Sistem			Zrak - voda	
Vrsta operacije			Ogrevanje / hlajenje	
Testirano			EHPA lab	
Inverterska tehnologija			Emerson Copeland Scroll	
Upravljanje sistema			Siemens RVS 21	
Rezervno napajanje			Zunanji	
Nočno delovanje (zatemnitev)			Da, nastavljeni parametri	
Delovno območje vira toplote	°C	-23 do +37	-23 do +37	-23 do +37
Maks. izhodna temperatura kompresorja do -7°C	°C	65	65	65
Najnižja izhodna temperatura med hlajenjem (protitočni kondenzator)	°C	7	7	7
Nazivni pretok vode (ogrevanje) za Δt 5 K	m³/h	1,95	2,34	3,37
Največja zunanja izguba tlaka ogrevalnega sistema	kPa	5,5	6	7
Največji delovni pritisk vode	bar	3	3	3
Priključki za ogrevanje in povratno vodo		zunanj 1 1/4"	zunanj 1 1/4"	zunanj 1 1/4"
Priporočen premer priključne Cu cevi	mm	28	28	28
Hladilni krog				
Hladilno sredstvo 2)		R454B	R454B	R454B
Količina hladilnega sredstva	kg	1,2	1,4	1,6
Hladilni krog			hermetično zaprta	
Mehanske informacije, teža				
Dimenzije	mm	1271 x 600 x 1184	1271 x 600 x 1184	1271 x 600 x 1184
Teža	kg	205	205	205
Električni podatki				
Napajanje kompresorja	V/ Ph/ Hz	230/1~/50	400/3~/50	400/3~/50
Stikalni napajalnik z RVS	V/ Ph/ Hz	230/1~/50	230/1~/50	230/1~/50
Moč za električno bivalentnost	V/ Ph/ Hz	400/3~/50	400/3~/50	400/3~/50
Nazivna poraba energije za hlajenje A7/W35	kW	1,22	1,6	2,04
Tok A7/W35 (toplotna črpalka na fazo)	A	5,3	2,57	3,27
Zaščita zunanje enote (stikalna plošča brez električne bivalence)	A B	1 x 16	3 x 20	3 x 25
Dobava za stikalno ploščo toplotne črpalke CYKY	n x mm3	3 x 2,5	5 x 2,5	5 x 4
Hrupnost				
Zvočna moč LwA, nazivni zvočni tlak LWP 1m	dB(A)	52 / 47	53 / 47	54 / 50
Nazivni zvočni tlak LpA 3) / nočno dušenje	dB(A)	32 / 25	34 / 27	36 / 29

1) Pod pogoji 7°C zraka na vstopu v toplotno črpalko in vode 35°C na izstopu iz toplotne črpalke. (V skladu z evropskim standardom EN 14511)

2) V skladu z evropskim standardom EN 14825 za povprečne podnebne razmere.

3) Dimenzije kabljskih povezav in velikost varovalk je predvidena za osnovno konfiguracijo toplotne črpalke - kompresor, ventilator, obtočne črpalke in regulacijo.

4) Izračunano za največjo dolžino 25m.



TOPLOTNA ČRPALKA ZRAK / VODA HOTJET ONE ZET - monoblock inverter - notranja postavitev

Koda	Naziv	Tehnični podatki	Cena
HJ7ZETXn	Hotjet ONE ZET7	A7/W35 : 6,25 / 5,1	10.199,20
EKOHJ10ZETXn	Hotjet ONE ZET10	A7/W35 : 8,04 / 5,02	11.321,60
EKOHJ20ZETXn	Hotjet ONE ZET20	A7/W35 : 10,29 / 5,03	12.431,80

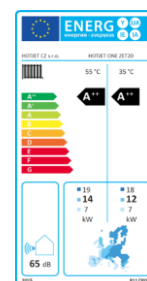
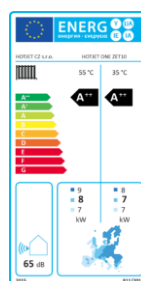
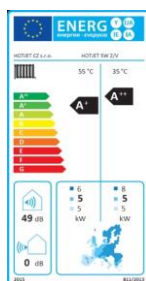

Tehnični podatki	HJ7ZETXn	EKOHJ10ZETXn	EKOHJ20ZETXn
Podatki o učinkovitosti	Moč ogrevanja [kW] / Poraba energije [kW] / Faktor ogrevanja [COP]		
Moč ogrevanja (min/max)	0,9-8kW	2-10,7kW	3-14,5kW
Ogrevanje: A7/W35 - toplotna moč / priključna moč / grelno število [COP] ¹⁾ kW / kW / -	6,25 / 5,1	8,04 / 5,02	10,29 / 5,03
Ogrevanje: A2/W35 - toplotna moč / priključna moč / grelno število [COP] ¹⁾ kW / kW / -	4,33 / 4,09	6,35 / 4,04	8,33 / 4,11
Ogrevanje: A7/W35 - toplotna moč / priključna moč / grelno število [COP] ¹⁾ kW / kW / -	3,82 / 3,55	5,57 / 3,42	7,85 / 3,57
Nazivna toplotna moč	6	8	10
Hlajenje: A35/W7 hladilna zmogljivost / poraba energije / faktor hlajenja [EER] 1)	4,90 / 2,81		12,20 / 2,65
Hlajenje: A35/W18 hladilna zmogljivost / poraba energije / faktor hlajenja [EER] 1)	5,7 / 3,61		12,77 / 3,81
Hlajenje: A27/W18 hladilna zmogljivost / poraba energije / faktor hlajenja [EER] 1)	5,8 / 3,92		18,2 / 4,11
Hlajenje: nazivna moč	5	6	11
Razred energijske učinkovitosti za 35°C 2)	A++	A++	A++
Razred energijske učinkovitosti za 55°C 2)	A++	A++	A++
Tehnične lastnosti			
Nazivna temperatura vira, območje delovanja [°C]	-23 do 37°C	-23 do 37°C	-23 do 37°C
Nazivna temperatura odjema min./max. [°C]		20 do 65°C (do -10°C)	20 do 65°C (do -10°C)
Delovno območje hlajenja	15 do 45°C	15 do 45°C	15 do 45°C
Priključki za ogrevanje in povratno vodo	1 1/4"	1 1/4"	1 1/4"
Nominalni pretok ogrevalne vode [m3 . h-1]	1	1,4	1,6
Dispozicijski tlak obtočne črpalke kPa	60	50	40
Zaščita ogrevalne vode pred zamrzitvijo	s spremljanjem temperature krmilnikov		
Hladilni krog			
Ekspanzijski ventil	Emerson EEV	Emerson EEV	Emerson EEV
Hladilno sredstvo	R454B	R454B	R454B
Teža hladilnega sredstva [kg]	1,1	1,3	1,6
Omejitev CO2	0,51t	0,61t	0,75t
Način odmrzovanja	reverzibilno	reverzibilno	reverzibilno
Ogrevanje posode za zbiranje kondenzata	S preostalo toploto hladilne tekočine		
Odvod kondenzata	Po cevi	Po cevi	Po cevi
Dimenzije. Teža			
Širina x globina x višina [mm]	1600 x 1000 x 800	1600 x 1000 x 800	1600 x 1000 x 800
Teža [kg]	180	200	220
Postavitev	notranja	notranja	notranja
Zaščita proti koroziji	Pocinkana pločevina + poliuretanski premaz		
Električni podatki			
Kompresor	Emerson copeland Scroll Inventor		
Električno napajanje kompresorja	1 x 230V AC, 50Hz	1 x 230V AC, 50Hz	3 x 230/ 400V AC, 50Hz
Električno napajanje el. kotla	3 x 230/ 400V AC, 50Hz	3 x 230/ 400V AC, 50Hz	3 x 230/ 400V AC, 50Hz
Nazivni tok pri A7/W35	5,3	2,57	3,27
Največja moč kompresorja (kW)	3,8	5	8
Varovalke	16B/3 - 400V	16B/3 - 400V	16B/3 - 400V
El. povezava do kompresorja CYKY [n x mm2]	5 x 2,5	5 x 2,5	5 x 4
Hrupnost			
Raven zvočne moči Lwa (dB)	56	58	60
Raven zvočnega tlaka Lpa 5m (dB)	35	38	39
Nočno dušenje, regulacija hitrosti glede na zunanjo temperaturo	da	da	da
Oprema			
Omarica z varnostnimi in regulacijskimi elementi	zunanja	zunanja	zunanja
Integrirana električna kartuša	da	da	da
Integrirana obtočna črpalka	da	da	da
Krmilni regulator	Siemens RVS21	Siemens RVS21	Siemens RVS21
Zunanji senzor	da	da	da
Daljnisko upravljanje preko interneta	webserver	webserver	webserver

1) Pod pogoji 7°C zraka na vstopu v toplotno črpalko in vode 35°C na izstopu iz toplotne črpalke. (V skladu z evropskim standardom EN 14511)

2) V skladu z evropskim standardom EN 14825 za povprečne podnebne razmere.

TOPLOTNA ČRPALKA ZRAK / VODA HOTJET ONE 2



Koda	Naziv	Moč (kW)	Cena
HOTJET20ONE2	Hotjet 20 ONE2	A7/W35 : 18,81 / 4,18 / 4,50	10.394,40
HOTJET25ONE2	Hotjet 25 ONE2	A7/W35 : 30,10 / 6,99 / 4,30	17.921,80
HOTJET45ONE2	Hotjet 45 ONE2	A7/W35 : 40,20 / 9,10 / 4,42	22.265,00

Ogrevanje do 63°C,
(opcija - aktivno hlajenje
Hydrobox), el. omarica
s Siemens regulacijo,
sobna / kontrolna enota
QAA75, EC ventilator,
Danfoss softstarter

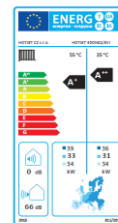
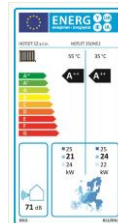
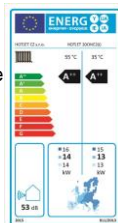

Tehnični podatki	HOTJET20ONE2	HOTJET25ONE2	HOTJET45ONE2
Podatki o učinkovitosti	Moč ogrevanja [kW] / Poraba energije [kW] / Faktor ogrevanja [COP]		
Ogrevanje: A7/W35 1)	18,81 / 4,18 / 4,50	30,10 / 6,99 / 4,30	40,2 / 9,1 / 4,42
Ogrevanje: A2/W35 1)	15,62 / 4,21 / 3,71	25,20 / 6,43 / 3,62	33,60 / 8,85 / 3,74
Ogrevanje: A-7/W35 1)	11,66 / 3,7 / 3,15		
Ogrevanje: A-7/W55 1)	16,91 / 5,79 / 2,92	29,99 / 10,99 / 2,73	40,1 / 14,32 / 2,8
Ogrevanje: A-2/W55 1)	14,48 / 5,74 / 2,52	25,73 / 10,90 / 2,36	34,35 / 14,08 / 2,44
Ogrevanje: A-7/W55	12,29 / 5,66 / 2,17	21,94 / 10,74 / 2,04	29,21 / 13,66 / 2,14
Razred energijske učinkovitosti 35°C 2)	A++	A++	A++
Razred energijske učinkovitosti 55°C 2)	A+	A++	A+
Hlajenje: A35/W7 4)	14,00 / 5,80 / 2,40	22	28,32 / 11,79 / 2,4
Tehnični podatki			
Nazivna temperatura vira, območje delovanja [°C]	-22 do 40°C	-22 do 40°C	-22 do 40°C
Nazivna temperatura odjema min./max. [°C]	20 do 62°C (do -10°C)	20 do 62°C (do -10°C)	20 do 62°C (do -10°C)
Priključki na toplotni črpalki	G 5/4" ZN	G 5/4" ZN	G 5/4" ZN
Nominalni pretok na strani segrevanja Δt = 5 °C [m3 . h-1]	3,37	5,18	7,64
Minimalni pretok na strani segrevanja Δt = 7 °C [m3 . h-1]	2,4	3,69	5,46
Padeč tlaka [kPa]	7	9	10,3
Koeficient pretoka Kvs [-]	12,7	17,2	-
Zaščita ogrevalne vode pred zamrzitvijo		Da (mora biti priključena na el. omrežje)	
Pretok zraka [m3 . h-1]	5000	8400	12300
Ekspanzijski ventil	Elektronsko nadzorovan: 1 x glavni, 1 x vbrizg plina EVI		
Z EVI vbrizgom plina	Da	Da	Da
Plin	R407C	R407C	R407C
Odtaljevanje	Samodejno ali na zahtevo		
Količina plina	5	11,5	15,4
Način odtaljevanja	Z vročim plinom (vzratno ogrevalni krog) * v primeru hlajenja 11,5kg v 25 ONE2		
Ogrevanje lovilne posode za kondenz	S preostalo toploto plina		
Odvod kondenza [mm]	Ø30	Ø30	Ø30
Ogrevanje odtočne cevi za kondenz	Optimizirana funkcija v regulaciji pripravljena		
Stikalo za nizek tlak (izklop) [MPa]	0,05	0,05	0,05
Stikalo za visok tlak (izklop) [MPa]	3,2	3,2	3,2
Dimenzije, teža			
Širina x globina x višina [mm]	1270 x 500 x 1210	1621 x 600 x 1483	1721 x 700 x 1680
Teža [kg]	205	250	370
Mesto montaže	Zunanja (po prilagoditvi notranja)		
Ohišje	Barvana z politeranskim UV odpornim lakom. Pocinkana pločevina		
Barva	RAL 7016 (možna zamenjava barve)		
Nazivna napetost	400V / 3 fazna / 50Hz		
Kompresor	Scroll EVI		
Nazivni tok A7/W35 [A]	8,4	11,2	16,4
Max. trenutni tok [A]	16,5	22	30
Zagonski tok [A]	73	80	96
Zagonski tok z mehkim zaganjačem	43,8	48	58
Varovalke za kompresor z mehkim zaganjačem	20C/3	25C/3	32C/3
Varovalke	25B/3	32B/3	40C/3
El. povezava do kompresorja CYKY [n x mm2] 3)	5 x 6	5 x 10	5 x 10
Električni podatki v kombinaciji z Hydrobox			
Glavne varovalke za toplotno črpalko s Hydrobox	25C/3	32C/3	-
El. povezava do toplotne črpalke s Hydrobox CYKY [n x mm2] 4)	5 x 4	5 x 6	-
Stopnja zaščite IPX (EN 60 529)	Z nameščeno nadzorno ploščo IP40		
Hrupnost	Po EN 12 102 pri A7 / W55 (najvišja zmogljivost)		
Nivo hrupa Lwa [dB]	max: 67	max: 71,5	max 76,5
Pritisk hrupa na Lpa 5 m [dB]	48	52,5	57,5
EC ventilator	630mm	800mm	900mm
Spremenljiva hitrost ventilatorja	Gladko, z regulacijo 0-10V signal. Funkcije: glede na temperaturo, nočno delovanje itd..		
Nadzor hrupa in zmogljivosti s spremembami hitrosti ventilatorja	Neprekinjeno, od regulacije s signalom 0-10V		
Oprema			
Električna kovinska omarica z regulacijo	Zunanja (398 x 647 x 166 - š/v/g) 16 kg		
Kontrolna enota	po izbiri AVS37 ali AVS74		
Električni kabel (med zunanjo enoto in krmilno omarico)	5m v sklopu zunanje enote (do 25m poskrbljeno za zaščito, nad 25m je potreben ponoven izračun)		
Siemens regulacija	RVS21+ razširitevni AVS55.199 + AVS75.370	RVS21 + razširitevni modul AVS55.196	
Raztezni ekspanzijski ventil	Z regulacijo RVS21	Neodvisna regulacija: Carel ali Emerson	
Kontrola faz	Da (pri RVS21 zunanja, RVS61 notranja)		
Sobna kontrolna enota (žična)	QAA75 (žična), QAA78 (brežžična)		
Zunanje tipalo	Dodatno (QAC34)		
Upravljanje preko interneta	Da (z webserverjem za 1, 4 ali 16 regulacij)		
Kaskada	Do 16 enot (RVS21 z povezovalnim modulom, RVS61 standardno)		
MODBUS komunikacija	Da (z razširitevni Modbus komunikacijskim modulom)		

1) Pod pogoji 7°C zraka na vstopu v toplotno črpalko in vode 35°C na izstopu iz toplotne črpalke. (V skladu z evropskim standardom EN 14511)
 2) V skladu z evropskim standardom EN 14825 za povprečne podnebne razmere.
 3) Dimenzije kablskih povezav in velikost varovalk je predvidena za osnovno konfiguracijo toplotne črpalke - kompresor, ventilator, obtočne črpalke in regulacijo.
 4) Izračunano za največjo dolžino 25m.



TOPLOTNA ČRPALKA ZEMLJA / VODA HOTJET W - inverter

Koda	Naziv	Tehnični podatki	Cena
HJB7WX	HOTJET5W	B0/W35: moč 3,7 kW poraba energije: 0,73 kW, COP 5,1	7.795,80
HJB10WX	HOTJET10W	B0/W35: moč 5,3 kW poraba energije: 1,07 kW, COP 4,95	8.332,60
EKOHJB15WX	HOTJET15W	B0/W35: moč 7,97 kW poraba energije: 1,65 kW, COP 4,8	9.357,40
EKOHJW33H	HOTJET33W	B0/W35: moč 28,57 kW poraba energije: 6,1 kW, COP 4,7	12.907,60

Ogrevanje, aktivno hlajenje (opcija), pasivno hlajenje, Siemens regulacija

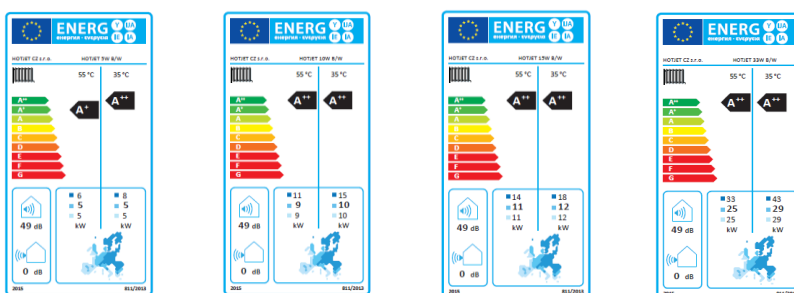

TOPLOTNA ČRPALKA VODA / VODA HOTJET W - inverter

Koda	Naziv	Tehnični podatki	Cena
EKOHJW7WX	HOTJET5W	W10/W35: moč 4,7 kW poraba energije: 0,7 kW, COP 6,4	7.978,80
EKOHJW10WX	HOTJET10W	W10/W35: moč 6,3 kW poraba energije: 0,98 kW, COP 6,4	8.479,00
EKOHJW15WX	HOTJET15W	W10/W35: moč 9,46 kW poraba energije: 1,52 kW, COP 6,2	9.491,60

Ogrevanje, aktivno hlajenje (opcija), pasivno hlajenje, Siemens regulacija

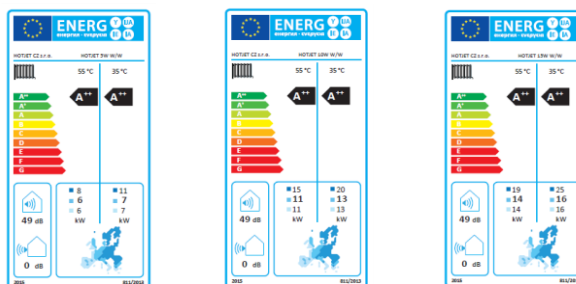

Tehnični podatki	HJB 7WX	HJB 10WX	EKO HJB 15WX	EKO HJW 33H	EKO HJW 7WX	EKO HJW 10WX	EKO HJW 15WX
Podatki o učinkovitosti							
Moč ogrevanja [kW] / Poraba energije [kW] / Faktor ogrevanja W [COP]							
Ogrevanje: B0/W35 zemlja-voda: ogrevalna moč / vhodna moč / COP 1)	3,7 / 0,73 / 5,1	5,3 / 1,07 / 4,95	7,97 / 1,65 / 4,8	28,57 / 6,1 / 4,7			
Ogrevanje: B0/W35 zemlja-voda: Pdesign / SCOP 2)	9,09 / 5,76	12,62 / 5,77	19,18 / 5,55				
Ogrevanje: B0/W35 zemlja-voda: obseg delovanja	2,6 - 9,4	3,6 - 13	5,5 - 19,7				
Ogrevanje: B0/W55 zemlja-voda: ogrevalna moč / vhodna moč / COP 1)	4,7 / 1,38 / 3,4	6,5 / 1,97 / 3,3	9,92 / 3,18 / 3,1	25,29 / 9,1 / 2,78			
Ogrevanje: B0/W55 zemlja-voda: Pdesign / SCOP 2)	8,55 / 4,28	11,87 / 4,28	18,05 / 4,21				
Ogrevanje: B0/W55 zemlja-voda: obseg delovanja	3 - 8,8	4,1 - 12	6,3 - 18,1				
Ogrevanje: W10/W35 voda-voda: ogrevalna moč / COP 1)	4,5 / 0,7 / 6,4			4,5 / 0,7 / 6,4	6,3 / 0,98 / 6,4	9,46 / 1,52 / 6,2	
Ogrevanje: W10/W35 voda-voda: Pdesign / SCOP 2)	9,19 / 7,44			9,19 / 7,44	12,77 / 7,45	19,41 / 7,28	
Ogrevanje: W10/W35 voda-voda: obseg delovanja	4 - 11 4,4 - 15,2 7 - 23			4 - 11 4,4 - 15,2 7 - 23	4,4 - 15,2	7 - 23	
Ogrevanje: W10/W55 voda-voda: ogrevalna moč / COP 1)	5,5 / 1,47 / 3,73			5,5 / 1,47 / 3,73	7,7 / 2,09 / 3,68	9,65 / 2,69 / 3,58	
Ogrevanje: W10/W55 voda-voda: Pdesign / SCOP 2)	9,16 / 5,64			9,16 / 5,64	12,72 / 5,66	19,33 / 5,51	
Ogrevanje: W10/W55 voda-voda: obseg delovanja	4 - 10,5			4 - 10,5	5 - 14	7,2 - 20,5	
Razred energijske učinkovitosti 35°C / 55°C	A+++ / A+++			A+++ / A+++	A+++ / A+++	A+++ / A+++	A+++ / A+++
Tehnični podatki							
Delovno območje vira toplote: voda °C	>3	>3	>3	>3	>3	>3	>3
Delovno območje vira toplote: zemlja °C	-10 do +30 (antifriz)						
Izhodna temperatura ogrevalne vode min / maks °C	15 do +60	15 do +60	15 do +60	15 do +55	15 do +60	15 do +60	15 do +60
Priključki na toplotni črpalke	zunanj G1"	zunanj G1"	zunanj G1"	zunanj G1"	zunanj G1"	zunanj G1"	zunanj G1"
Sekundarni krog							
Pretok vode skozi ogrevalni krog Δt = 5 °C (m³, h-1)	1,25	1,25	1,25		1,25	2,26	2,79
Najmanjši prostorninski pretok na ogrevalni strani Δt = 7 °C (m³, h-1)	0,9	0,9	0,9		0,9	1,59	2
Priključki na toplotni črpalke	zunanj G1"	zunanj G1"	zunanj G1"		zunanj G1"	zunanj G1"	zunanj G1"
Zaščita ogrevalne vode pred zamrzitvijo	Da (dodatna regulacijska elektronika)						
Hladilni krog							
Ekspanzijski ventil	Elektronsko krmiljen						
Hladilno sredstvo	R410A / R454B	R410A / R454B	R410A / R454B	R410A / R454B	R410A / R454B	R410A / R454B	R410A / R454B
Teža polnjenja (hladilno sredstvo) kg	1,3	1,3	1,3	3,2	1,3	1,4	1,5
Izklopni tlak visokotlačnega stikala Mpa	4,5	4,5	4,5	3	4,5	4,5	4,5
Tehnični podatki (mere, teža)							
Širina x globina x višina [mm]	600 x 700 x 1 000	600 x 700 x 1 000	600 x 700 x 1 000	1123 x 647 x 1166	600 x 700 x 1 000	600 x 700 x 1 000	600 x 700 x 1 000
Teža [kg]	130	130	130	175	130	135	140
Mesto montaže	Notranja	Notranja	Notranja	Notranja	Notranja	Notranja	Notranja
Zaščita ohišja	Komaxit	Komaxit	Komaxit	Komaxit	Komaxit	Komaxit	Komaxit
Barva	RAL 7035	RAL 7035	RAL 7035	RAL 7035	RAL 7035	RAL 7035	RAL 7035
Električni podatki							
Nazivna napetost	230V / 1 faza / 50Hz	230V / 1 faza / 50Hz	230V / 1 faza / 50Hz	400V / 3 faze / 50Hz	230V / 1 faza / 50Hz	400V / 3 faze / 50Hz	
Kompresor	Copeland Variable Speed Scroll						
Max. trenutni tok B0/W55 [A]		7,19	8,53	22,2		7,19	8,53
Zaščita dovoda toplotne črpalke	16B / 1	16B / 1	16B / 1	25C / 3	16B / 1	20B / 3	20B / 3
El. povezava do toplotne črpalke CYKY [n x mm²]	3 x 4	3 x 4	3 x 4	5 x 6 (rez.5,3kW/400W)	3 x 4	5 x 4	5 x 4
Stopnja zaščite IPX (EN 60 529)	IP21	IP21	IP21	IP21	IP21	IP21	IP21
Hrupnost							
Raven zvočne moči LWA B0/W55 (2275rpm) dB	40,7	40,7	40,7	< 53	40,7	40,7	40,7
Oprema							
Električna kovinska omarica z regulacijo	V napravi	V napravi	V napravi	Ločena (proti doplačilu) / v napravi	V napravi	V napravi	V napravi
Vgrajena obtočna črpalka za drugi krog	UPM3K 15-75	UPM3K 15-75	UPM3K 15-75		UPM3K 15-75	UPM3K 15-75	UPM3K 15-75
Integrirano pretočno stikalo za primarni krog	senzor PT1000	senzor PT1000	senzor PT1000		senzor PT1000	senzor PT1000	
Integrirano pretočno stikalo za sekundarni krog	senzor PT1000	senzor PT1000	senzor PT1000		senzor PT1000	senzor PT1000	
Siemens regulacija	RVS21 + AVS55	RVS21 + AVS55	RVS21 + AVS55	RVS21 + AVS55	RVS21 + AVS55	RVS21 + AVS55	RVS21 + AVS55
Nadzorna plošča	AVS74	AVS74	AVS74	AVS37 / QAA74	AVS74	AVS74	AVS74
Zunanje tipalo	QAC34	QAC34	QAC34	QAC34	QAC34	QAC34	QAC34
Žični krmilnik	QAA74	QAA74	QAA74	QAA75 / QAA55	QAA74	QAA74	QAA74
Daljiško upravljanje preko interneta OZW672	Neobvezno z 2-letno garancijo, obvezno s 5-letno garancijo			Da (z webserverjem za 1, 4 ali 16 regulacij)	Neobvezno z 2-letno garancijo, obvezno s 5-letno garancijo		
MODBUS komunikacija	Da (z razširjenim Modbus komunikacijskim modulom)						
1) V skladu s standardom EN 14511							
2) V skladu s standardom EN 14511 za hladno cono							
3) V skladu s standardom ČSN EN 14825							

NADZOR PREKO INTERNETA SIEMENS

OCI345.06	OCI351.1	OZW672.01	OZW672.04	AVS75.391	AVS75.370
LPB modul (za kaskadno povezavo RVS21)	LPB Modbus modul (za kaskadno povezavo RVS21)	WEB server - možen nadzor toplotne črpalke, upravljanje preko interneta	WEB server - možen nadzor do 4-ih toplotnih črpalk, upravljanje preko interneta	Razširitveni modul	Razširitveni modul
150,06	189,10	600,24	1.273,68	314,76	331,84

QAA58COOLSOLO	QAA55.110/301	QAA2030	RGQ74	RGA74	RGA37
Sobna enota QAA58.301/701	Sobna enota (hlajenje) QAA55	Sobni senzor	Napredna sobna enota QAA74	Kontrolna enota QAA74	Kontrolna plošča (odprodaja)
240,34	158,60	56,12	363,56	265,96	265,96

AVS71.393/101	AVS71.390/109	OCI700.1
Brezžični sprejemnik AVS71.393	Brezžični sprejemnik AVS71.390 (odprodaja)	Servisno orodje
206,18	206,18	605,12

QAC34	QAD36/101	QAZ36.522/109	QAZ36.526	QAZ36.481
Zunanje tipalo QAC34	Naležno tipalo QAD36/101 (odprodaja)	Tipalo QAZ36 kabel dolžina 2m	Tipalo QAZ36 kabel dolžina 6m	Tipalo za solar QAZ36 OEM NTC10k -30°C do 200°C, kabel dolžina 1,5m
30,50	42,70	24,40	36,60	70,76

ELEKTRIČNI GRELCI

EK75	3000-0092	GRELECPRET
Električni pretočni grelec HOTJET 7,5kW	Pretočni električni grelec 3-6-9 kW, brez regulacije	Grelec pretočni 2-4-6 kW
567,30	256,20	378,20

ELEKTRIČNI BOJLER ZA KUHINJO LYRA



Koda	Naziv	Volumen (L)	Cena
174831	Bojler za kuhinjo Lyra MT 8N - nadpultni	8	137,25
174832	Bojler za kuhinjo Lyra MT 8P - podpultni	8	137,25

TEHNIČNI PODATKI	LYRA MT 8N
Vrsta bojlerja:	Malolitražni bojler za kuhinje
Volumen:	8 L
Vgradnja:	Nadpultna / podpultna
Dimenzije (Š x V x D) mm:	274 x 396 x 266
Notranja obdelava:	Emajliran
Nosilec:	Razdalja lukenj 140mm
Varnostni ventil:	Da
MG anoda:	Da
Prirobnica:	Elipsasta
Izolacija	Polivretanska pena 15mm
Električni grelec:	1,5 kw (nikelj)
Delovni tlak:	6 bar
Napetost:	230 V
Energetski razred:	B
Za vse priključke	
Delovni in varnostni termostat	
Čas segrevanja vode na 75 23 min	
Teža:	7,3 kg
Garancija:	Na bojler 5 let, na rezervne dele 25 mesecev

ELEKTRIČNI BOJLER ZA SANITARNO VODO HYDRA



Koda	Naziv	Volumen (L)	Cena
098933	Bojler za sanitarno vodo Hydra MB P50 R	50	180,32
098935	Bojler za sanitarno vodo Hydra MB P80 R	80	192,52
108875	Bojler za sanitarno vodo Hydra MB P100 R	100	228,02
098937	Bojler za sanitarno vodo Hydra MB P120 R	120	270,84

TEHNIČNI PODATKI	HYDRA MB P_R			
Vrsta bojlerja:	Akumulacijski bojler za sanitarno vodo			
Volumen:	50 litrov	80 litrov	100 litrov	120 litrov
Vgradnja:	Vertikalna			
Dimenzije (ŠxV) mm:	454x605	454x825	454x965	454x1105
Notranja obdelava:	Emajliran			
Nosilec:	Univerzalni - razdalja lukenj 130-360 mm			
Varnostni ventil:	da			
MG anoda:	da			
Prirobnica:	Okrogla ø72			
Izolacija:	Polivretanska pena (purpen) 17-40 mm			
Električni grelec:	2 kW (bakreni)			
Delovni tlak:	6 bar			
Napetost:	230 V			
Energetski razred:	C			
Inox izlivna cev, palični termostat, zunanja regulacija temperature				
Čas segrevanja vode na 75°C:	110 min	175 min	220 min	265 min
Teža:	20,6 kg	26,1	30,5	35,2
Garancija:	Na bojler 5 let, na rezervne dele 25 mesecev			

ELEKTRIČNI BOJLER ZA SANITARNO VODO HYDRA HORIZONTALNI

Koda	Naziv	Volumen (L)	Cena
111441	Bojler za sanitarno vodo horizontalni Hydra EZV P80HL - levi priključek	80	241,56
111444	Bojler za sanitarno vodo horizontalni Hydra EZV P80HD - desni priključek	80	241,56

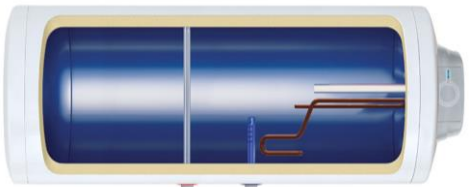

TEHNIČNI PODATKI	HYDRA EZV P80H
Vrsta bojlerja:	Bojler za sanitarno vodo
Volumen:	80 L
Vgradnja:	Horizontalna
Notranja obdelava:	Emajlirana
Dimenzije (ŠxV):	ø 395 mm x 1018mm
Nosilec:	Univerzalni - razdalja lukenj 130-360 mm
Varnostni ventil	Da
MG anoda:	Da
Prirobnica:	Okrogla ø72
Izolacija:	Polivretanska pena (purpen) 17-40 mm
Električni grelec:	2 kW (bakren)
Delovni tlak	6 bar
Napetost	230 V
Energetski razred:	C
Inox izlivna cev, palični termostat, zunanja regulacija temperature	
Čas segrevanja vode na 75°C:	200 min
Teža:	27,5 kg
Garancija:	Na bojler 5 let, na rezervne dele 25 mesecev

ELEKTRIČNI BOJLER KOMBINIRAN TAURUS

Koda	Naziv	Cena
343706	Bojler kombinirani Taurus MB PKL 50 R - levi priključek	249,25
343756	Bojler kombinirani Taurus MB PKD 50 R - desni priključek	249,25
124211	Bojler kombinirani Taurus MB PKL 80 R - levi priključek	279,26
124219	Bojler kombinirani Taurus MB PKD 80 R - desni priključek	279,26
124308	Bojler kombinirani Taurus MB PKL 120 R - levi priključek	361,00
124309	Bojler kombinirani Taurus MB PKD 120 R - desni priključek	361,00



TEHNIČNI PODATKI	TAURUS MB PKL_R		
Vrsta bojlerja:	Kombinirani bojler za sanitarno vodo		
Volumen:	50 litrov	80 litrov	120 litrov
Vgradnja:	Vertikalna		
Dimenzije (ŠxV) mm:	454 x 605	454 x 825	454 x 1105
Notranja obdelava:	Emajliran		
Nosilec:	Univerzalni - razdalja lukenj 130-360 mm		
Varnostni ventil:	da		
MG anoda:	da		
Prirobnica:	Okrogla ø72		
Izolacija:	Polivretanska pena (purpen) 17-40 mm		
Električni grelec:	2 kW (nikelj)		
Moč izmenjevalca (spirale):	7 kW		
Delovni tlak:	6 bar		
Napetost:	230 V		
Energetski razred:	C		
Delovni in varnostni termostat			
Čas segrevanja vode na 75°C:	110 min	175 min	265 min
Teža:	23,6 kg	31,6 kg	40,3kg
Garancija:	Na bojler 5 let, na rezervne dele 25 mesecev		

*Po naročilu

KOMBINIRANI TLAČNI BOJLER SGW(S) NEPTUN KOMBI - viseči

Koda	EAN	Volumen (l)	Izmenjevalec (m ²)	Višina (mm)	Premer (mm)	Cena
06-084670	5901224415432	80	desni 0,6	920	480	454,69
06-084671	5901224415449	80	levi 0,6	920	480	454,69
06-104670	5901224415456	100	desni 0,6	1080	480	484,58
06-104671	5901224415463	100	levi 0,6	1080	480	484,58
06-124670	5901224414817	120	desni 0,95	1200	480	551,07
06-124671	5901224416897	120	levi 0,95	1200	480	551,07
06-144670 *	5901224420054	140	desni 0,95	1340	480	565,59
06-144671 *	5901224416392	140	levi 0,95	1340	480	565,59

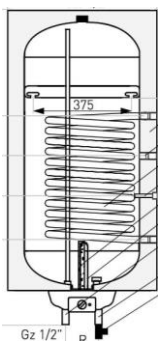

KOMBINIRANI TLAČNI BOJLER SGW(S) VULCAN KOMBI - viseči

Koda	EAN	Volumen (l)	Izmenjevalec (m ²)	Višina (mm)	Premer (mm)	Cena
26-105600 *	5901224407598	100	1,2	1050	455/455	664,66
26-125600 *	5901224422423	120	1,2	1150	455/455	705,53
26-145600 *	5901224414589	140	1,2	1300	455/455	741,15

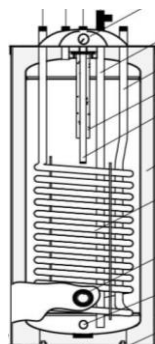

KOMBINIRANI TLAČNI BOJLER SGW(S) VULCAN KOMBI - stoječi

Koda	EAN	Volumen (l)	Izmenjevalec (m ²)	Višina (mm)	Premer (mm)	Cena
26-105500 *	5901224416057	100	1,2	1050	455/455	664,66
26-125500 *	5901224407604	120	1,2	1150	455/455	705,53
26-145500 *	5901224413995	140	1,2	1300	455/455	741,15
26-205500 *	5901224531941	200	1,6	1190	650/650	1.002,11

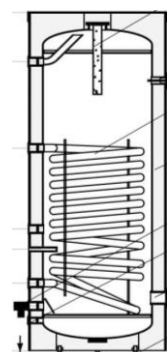

KOMBINIRANI TLAČNI BOJLER SGW(S) MINI TOWER - stoječi

Koda	EAN	Volumen (l)	Izmenjevalec (m ²)	Višina (mm)	Premer (mm)	Cena
26-108000 *	5901224420641	100	0,6	1040	518	554,86
26-128000 *	5901224419027	120	0,95	1150	518	593,41
26-148000 *	5901224417481	140	0,95	1290	518	644,77



*Po naročilu

BOJLER SG(S) trda izolacija

Koda	EAN		Volumen (l)	Višina (mm)	Premer (mm)	Cena
22-108000	5901224420641	*	100	1040	518	477,87
22-128000		*	120	1150	518	519,11
22-148000		*	140	1290	518	545,46
22-208000N		*	200	1100	670	724,56
22-308000N	5901224541513	*	300	1615	670	924,03
22-408000N		*	400	1750	700	1.189,87
22-504000N	5901224552496	*	500	1950	755	1.516,46
22-704000N		*	720	2080	860	2.373,14
34-104000N		*	1000	1990	900	3.000,35
34-154000N	5901224545788	*	1500	2680	900	4.004,41

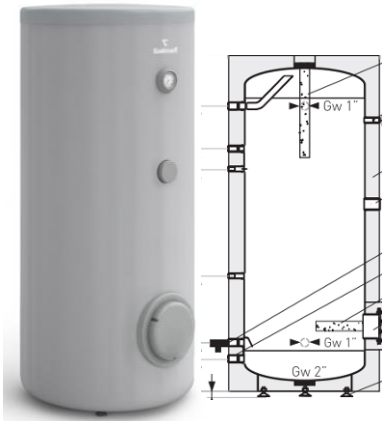

BOJLER SGW(S) TOWER z enim izmenjevalcem trda izolacija

Koda	EAN	Volumen (l)	Izmenjevalec spodnji (m ²)	Višina (mm)	Premer brez / z izolacijo (mm)	Cena
TOWER trda izolacija 70mm						
26-208000	5901224540677	200	1,4	1100	550/670	890,67
26-308000N	5901224558467	300	1,4	1615	550/670	1.106,82
26-408000N	5901224563706	400	1,8	1750	600/700	1.384,21
26-504000N	5901224559884	500	1,8	1950	630/755	1.720,57
BIG TOWER trda izolacija 70mm						
26-704000N *	5901224566059	720	2,4	2050/2080	700/855	2.581,89
BIG TOWER mehka izolacija 100mm						
26-704600 *		720	2,4	2050/2080	700/860	2.581,89
36-104600 *		1000	2,7	1960/1990	900/1060	3.191,64
36-154600 *		1500	2,7	2650/2680	900/1100	4.404,44

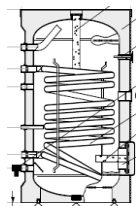

200 l

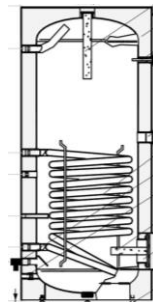

250-300 l

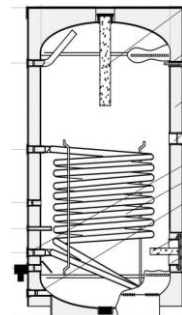

big tower 800-1000 l

BOJLER SGW(S) B TOWER BIWAL Z DVEMA IZMENJEVALCEMA - trda izolacija

Koda	EAN	Volumen (l)	Izmenjevalec (m ²) zgornji - spodnji (sonč.kolekt.)		Višina (mm)	Premer brez / z izolacijo (mm)	Cena
26-209000	5901224518478	200	0,7	1,0	1140	550/670	1.103,66
26-309000N	5901224558474	300	1,1	1,4	1615	550/670	1.219,07
26-409000N	5901224558481	400	1,1	1,8	1750	600/700	1.476,57
26-509000N	5901224558498	500	1,1	2,0	1950	630/755	1.752,16
26-709000N *	5901224580666	720	1,2	2,4	2080	700/860	2.658,62
36-109600N *	5901224538278	1000	1,5	2,7	1990	900/1060	3.326,94
36-159600N *		1500	1,5	2,7	2680	900/1100	4.509,36

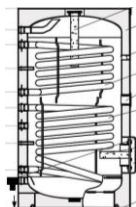

200 l

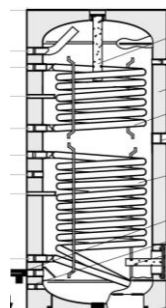

250 - 500 l

*Po naročilu

BOJLER ZA TOPLOTNO ČRPALKO SGW(S) MAXI Z VEČJIM IZMENJEVALCEM - trda izolacija



Koda	EAN	Volumen (l)	Izmenjevalec zgornji (m ²)	Višina (mm)	Premer brez / z izolacijo (mm)	Cena
26-258500N	5901224544439	250	2,9	1380	550/670	1.520,49
26-308500N	5901224558504	300	3,6	1615	550/670	1.600,64
26-408100N	5901224558511	400	5,0	1750	600/700	1.925,65
26-504100N	5901224561726	500	6,0	1950	630/755	2.335,69
26-704100N	5901224563898	700	605,0	2050	700/855	3.924,01

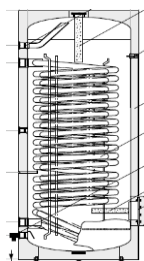

250-500 l

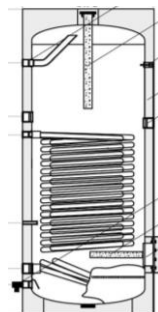

720-1000 l

BOJLER ZA TOPLOTNO ČRPALKO SGW(S) TOWER GRAND



Koda	EAN	Volumen (l)	Izmenjevalec zgornji (m ²)	Višina (mm)	Premer brez / z izolacijo (mm)	Cena
26-168107 *	5901224579875	160	1,4	920	550/670	869,01
26-208107	5901224583117	200	2,0	1140	550/670	1.103,25
26-308107N	5901224587313	300	2,7	1615	550/670	1.455,22
26-408107N *	5901224583964	400	4,1	1750	600/700	1.701,41
26-504107N *	5901224579776	500	4,3	1950	630/755	2.084,37

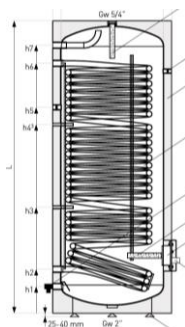

160-500 l

BOJLER ZA TOPLOTNO ČRPALKO SGW(S)B MAXI PLUS Z DVEMA VEČJIMA IZMENJEVALCEMA - trda izolacija



Koda	EAN	Volumen (l)	Izmenjevalec (m ²)		Višina (mm)	Premer brez / z izolacijo (mm)	Cena
			zgornji toplotna črpalka (m ²)	spodnji sončni kolektor (m ²)			
26-309100N	5901224561733	300	2,2	1,0	1615	550/670	1.925,65
26-409100N *	5901224566202	400	3,8	1,5	1750	600/700	2.140,00
26-509100N *		500	4,8	1,8	1950	630/755	2.581,76

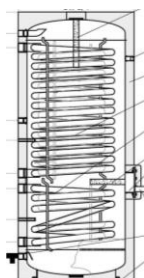

300-500 l



Izmenjevalec v dveh špiralah

*Po naročilu

ELEKTRIČNI GRELCI za bojlerje



Koda	EAN	Naziv	Moč (kW)	Napetost (V)	Priklj uček	Cena
41-020001EX	5901224814709	Električni grelec	2	230	5/4"	73,24
41-030001EX	5901224830631	Električni grelec	3	230	5/4"	88,30
41-020011EX	5901224814716	Električni grelec	2	230	6/4"	73,24
41-030011EX	5901224830648	Električni grelec	3	230	6/4"	93,40
41-045011	5901224841040	Električni grelec	4,5	400	6/4"	340,06
41-060011	5901224841057	Električni grelec	6	400	6/4"	358,99



Koda	EAN	Naziv	Moč (kW)	Napetost (V)	Priklj uček	Cena
GB01.2054		V.Električni grelec 2kW 5/4"	2	230	5/4"	73,57
GB01.2064		V.Električni grelec 2kW 6/4"	2	230	6/4"	73,57
GB01.3054		V.Električni grelec 3kW 5/4"	3	230	5/4"	88,30
GB01.3064		V.Električni grelec 3kW 6/4"	3	230	6/4"	93,40



PRIROBNICA za bojler

Koda	EAN	Naziv	Priključek	Cena
40-300230		Prirobnica 180mm z mufno	6/4"	58,80

POTOPNA TULKA za tipalo



Koda	EAN	Naziv	Cena
14880		Potopna tulka za 1 tipalo 1/2"- 7 x 9 x 100	7,61
14881	8595222651113	Potopna tulka za 1 tipalo 1/2"- 7 x 9 x 200	13,91
15744	8595222657450	Potopna tulka za 3 tipala 1/2"- 13,5 x 16 x 100	8,23
15743	8595222657443	Potopna tulka za 3 tipala 1/2"- 13,5 x 16 x 230	15,65
14882	8595222651120	Potopna tulka za 4 tipala 1/2"- 15 x 17 x 120	8,75
M-010085	5901224070075	Potopna tulka 1/2" dolž. 350mm (40 - 80 litrov)	17,26
M-013178	5901224070075	Potopna tulka 1/2" dolž. 700mm (100-140 litrov)	22,51

MALI ZALOGOVIKI ZA TOPLOTNE ČRPALKE GALMET SG(B) zidna montaža - GRETJE / HLAJENJE

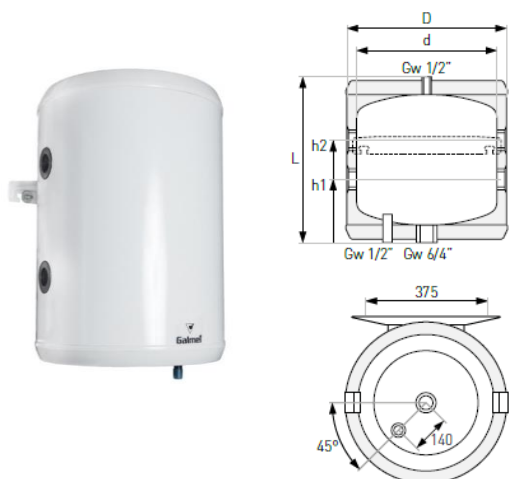

Koda	EAN	Volumen (l)	Višina (mm)	Premer (mm)	Cena
70-067000	5901224337307	63	680	460	262,54
70-087000 *		86	865	460	301,58
70-107000	5901224337321	106	1015	460	336,23
70-127000 *		118	1115	460	373,56
70-147000 *		136	1265	460	407,60

MALI ZALOGOVIKI ZA TOPLOTNE ČRPALKE G. LEON - GRETJE



Koda	Naziv	Volumen (l)	Višina (mm)	Premer (mm)	Cena
Z40 *	Zalogovnik Leon 40 L CK stenski				173,24
	1x pritrdilna konzola na zadnji strani	40	450	450	
Z50	Zalogovnik Leon 50 L CK stenski				181,05
	1x pritrdilna konzola na zadnji strani	50	510	450	
Z60	Zalogovnik Leon 60 L CK stenski				201,30
	1x pritrdilna konzola na zadnji strani	60	600	450	
Z100	Zalogovnik Leon 100 L CK stenski				232,78
	2x pritrdilna konzola na zadnji strani	100	905	450	
Z100N	Zalogovnik Leon 100 L CK talni				267,42
	Nogice pri talni izvedbi zalogovnika	100	905	450	
Z150N	Zalogovnik Leon 150 L CK talni				321,35
	Nogice pri talni izvedbi zalogovnika	150	1300	450	

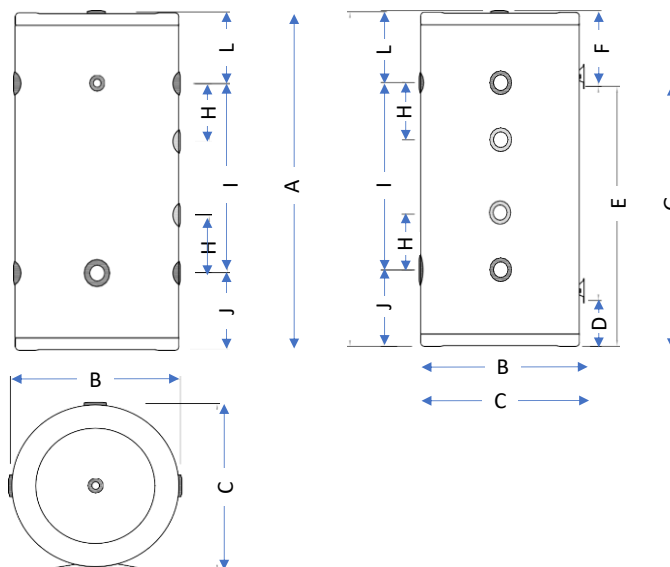

	A	B	C	D	E	F	G	H	I	J	L
40 lit	450	450	460	/	/	185	265	/	95	185	190
60 lit	600	450	460	/	/	190	410	/	210	200	190
80 lit	745	450	460	/	/	190	555	100	365	200	190
100 lit	905	450	460	115	600	190	685	100	530	190	190
120 lit	1080	450	460	120	770	190	990	100	495	200	190
150 lit	1300	450	460	110	995	190	1105	100	925	200	190

ZALOGOVNIK ZA OGREVANJE BREZ IZMENJEVALCA z izolacijo

Koda	EAN	Volumen zalogovnika (l)	Moč kotla (kW)	Teža z izolacijo (kg)	Delovni tlak / max.temp. bar / °C	Višina z izolacijo (mm)	Premer brez / z izolacijo (mm)	Cena
P150		150	6-10	38	3/95	1310	400/500	506,79
P200		200	6-10	47	3/95	1710	400/500	556,56

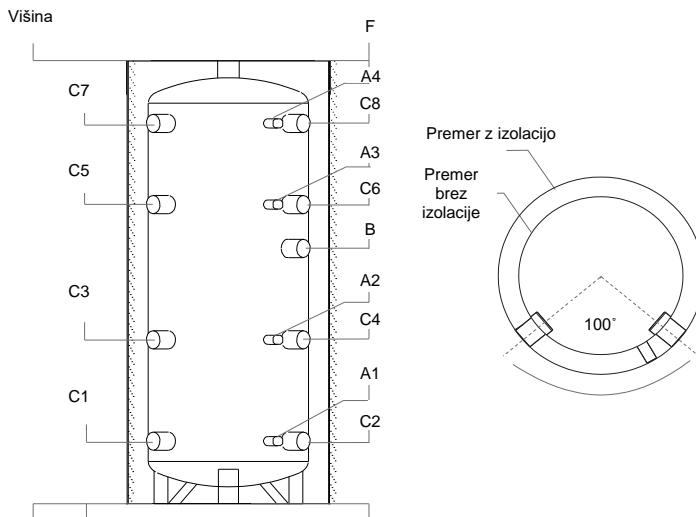

ZALOGOVNIK ZA OGREVANJE BREZ IZMENJEVALCA - izolacija posebej

Koda	EAN	Volumen zalogovnika (l)	Moč kotla (kW)	Teža brez / z izolacijo (kg)	Delovni tlak / max.temp. bar / °C	Višina brez / z izolacijo (mm)	Premer brez / z izolacijo (mm)	Cena
P300NI		300	6-10	60/70	3/95	1410/1460	650/750	636,35
P500NI		500	10-17	90/102	3/95	1610/1660	650/850	777,75
P800NI		800	15-27	118/134	3/95	1860/1910	790/990	990,15
P1000NI		1000	18-33	133/151	3/95	2040/2090	790/990	1.091,41
P1500NI		1500	27-50	206/229	3/95	2150/2220	1000/1200	1.716,66
P2000NI		2000	36-67	273/300	3/95	2132/2182	1200/1400	2.081,08

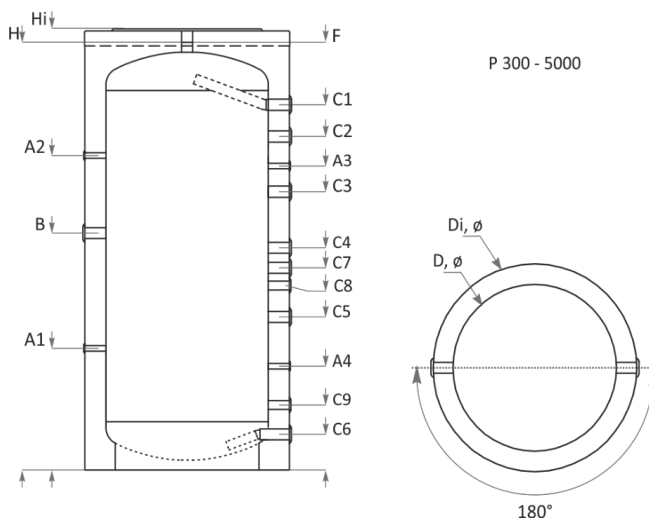
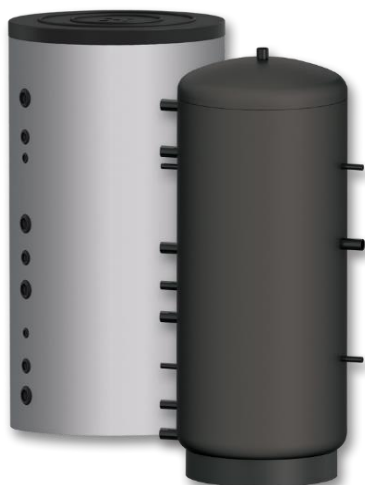

*Po naročilu

ZALOGOVNIK ZA OGREVANJE SG(B) 100-5000 L brez izmenjevalca - mehka izolacija



Koda	EAN	Volumen (l)	Višina in prekučna višina (mm)	Premer brez / z izolacijo (mm)	Cena
70-100400	5901224408113	100	1010-trda izolacija	400/500	409,43
70-200000	5901224718328	200	1140-trda izolacija	550/670	562,05
70-300000N	5901224316685	300	1615-trda izolacija	550/670	640,62
70-400000	5901224776014	380	1685-trda izolacija	600/700	798,49
70-500000	5901224791475	500	1925-trda izolacija	600/700	835,58
70-800600	5901224720000	800	1730/1995	790/950	1.105,32
70-100600	5901224720017	1000	2050/2270	790/990	1.225,86
70-150600 *	5901224720024	1500	2700/2920	900/1100	2.102,91
80-200600 *		2000	2500/2820	1100/1300	2.824,18
80-300600 *	5901224725043	3000	2750/3120	1250/1450	4.044,91
80-400600 *		4000	2355/2970	1600/1800	5.180,36
80-500600 *		5000	2855/3380	1600/1800	6.271,17

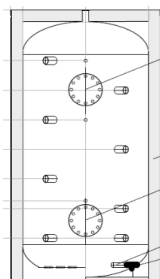
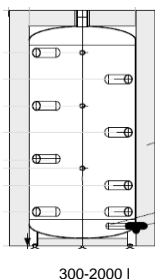
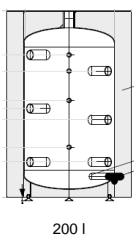

ZALOGOVNIK ZA OGREVANJE SG(B) 200-2000 L z enim izmenjevalcem - mehka izolacija

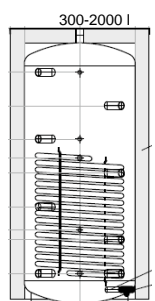
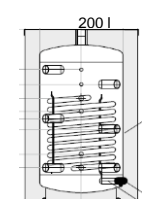

Koda	EAN	Volumen (l)	Izmenjevalec (m ²)	Višina in prekučna višina (mm)	Premer brez / z izolacijo (mm)	Cena
71-200000	5901224718342	200	1,4	1140-trda izolacija	550/670	705,77
71-300000N	5901224320675	300	1,4	1615-trda izolacija	550/670	785,19
71-400000		380	1,8	1660-trda izolacija	600/700	984,17
71-500000	5901224317385	500	2,5	1925-trda izolacija	600/700	1.049,44
71-800600		800	3,0	1730/1995	790/950	1.495,23
71-100600	5901224720031	1000	3,5	2050/2270	790/990	1.634,19
71-150600 *	5901224720048	1500	4,0	2700/2920	900/1100	2.432,56
81-200600 *		2000	4,5	2500/2820	1100/1300	3.386,72

ZALOGOVNIK ZA OGREVANJE SG(B) 380-2000 L z dvema izmenjevalcema - mehka izolacija

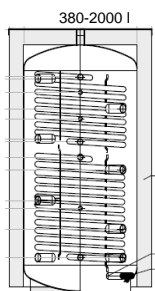

Koda	EAN	Izmenjevalec (m ²) spodnji / zgornji (sončni kolektor)	Volumen (l)	Višina in prekučna višina (mm)	Premer brez / z izolacijo (mm)	Cena
72-400000		1,4 1,8	400	1830-trda izolacija	700	1.266,60
72-500000		1,4 2,5	500	1905-trda izolacija	760	1.352,98
72-800600		1,8 3,0	800	1730/1995	950	1.716,66
72-100600		2,1 3,5	1000	2050/2270	990	1.986,53
72-150600		2,5 4,0	1500	2700/2920	1100	2.850,29
82-200600	5901224317422	2,7 4,5	2000	2500/2820	1300	4.026,12

*Po naročilu

ZALOGOVNIK Z INTEGRIRANIM BOJLERJEM SANITARNE VODE BREZ IZMENJEVALCA SG(K) KUMULO - mehka izolacija 10 mm



Koda	EAN	Volumen skupni (l)	Volumen bojlerja (l)	Volumen zalogov. (l)	Višina (mm)	Premer brez / z izolacijo (mm)	Cena
70-506000 *		500	160	340	1670	700/900	2.374,97
70-608000 *		600	200	400	1840	700/900	2.503,93
70-808600 *		800	200	600	1620	900/1100	2.714,01
70-108000 *		1000	200	800	1820	900/1100	2.982,53

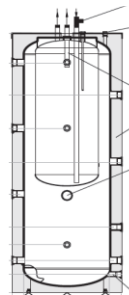

varnostni ventil odzračevanje DN ½"

magnezijeva anoda DN 5/4" izolacija

na električni grelec DN6/4"

izpust vode 1"



mehka izolacija

ZALOGOVNIK Z INTEGRIRANIM BOJLERJEM SANITARNE VODE Z ENIM IZMENJEVALCEM SG(K) KUMULO - mehka izolacija 10mm



Koda	EAN	Volumen skupni (l)	Volumen bojlerja (l)	Volumen zalogov. (l)	Izmenjev. (m²)	Višina (mm)	Premer brez / z izolacijo (mm)	Cena
71-506000	5901224702211	500	160	340	2,1	1670	700/900	2.488,19
71-608000	5901224702228	600	200	400	2,1	1840	700/900	2.724,02
71-808600 *		800	200	600	2,4	1650	900/1100	3.089,04
71-108600 *	5901224787621	1000	200	800	2,4	1850	900/1100	3.425,27

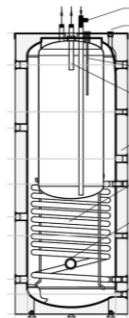

varnostni ventil odzračevanje DN ½"

tipalo

magnezijeva anoda DN 5/4" izolacija

toplotni izmenjevalec za sončno ogrevanje električni grelec DN6/4"

izpust vode 1"



mehka izolacija

ZALOGOVNIK Z INTEGRIRANIM BOJLERJEM SANITARNE VODE Z DVEMA IZMENJEVALCEMA SG(K) KUMULO - mehka izolacija



Koda	EAN	Volumen skupni (l)	Volumen bojlerja (l)	Volumen zalogov. (l)	Izmenjev. zgornji (m²)	Izmenjev. spodnji (m²)	Višina (mm)	Premer brez / z izolacijo (mm)	Cena
72-506000 *	5901224711510	500	160	340	1,0	2,1	1670	700/900	2.642,64
72-608000 *		600	200	400	1,0	2,1	1840	700/900	2.886,76
72-808600 *		800	200	600	1,0	2,4	1620	900/1100	3.300,34
72-108600 *		1000	200	800	1,0	2,4	1820	900/1100	3.610,71

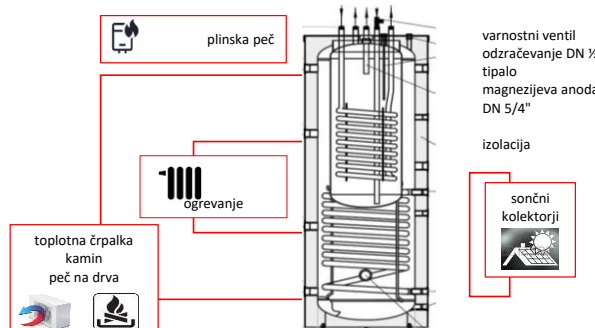

mehka izolacija

*Po naročilu

MULTI-INOX ZALOGOVNIK ZA SANITARNO VODO Z INOX IZMENJEVALCEM



Koda	EAN	Volumen zalogovn. (l)	Volumen inox izmenjev.(l)	Izmenjev. sanitarne vode (m ²)	Višina (mm)	Premer brez / z izolacijo (mm)	Cena
70-601600 *		600	39,0	5,65	1900	700/900	2.199,05
70-801600 *		800	39,0	5,65	1880	790/990	2.425,36
70-101600 *		1000	48,0	6,95	2270	790/990	2.727,43
70-151600 *		1500	48,0	6,95	2665	900/1100	3.655,49
80-201600 *		2000	56,0	8,0	2500	1100/1300	4.644,54

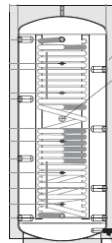

mehka izolacija

MULTI-INOX ZALOGOVNIK ZA SANITARNO VODO Z INOX IZMENJEVALCEM IN SPODNJIM IZMENJEVALCEM



Koda	EAN	Volumen zalogovn. (l)	Volumen inox izmenjev.(l)	Izmenjev. sanitarne vode (m ²)	Izmenjev. spodnji (m ²)	Višina (mm)	Premer brez / z izolacijo (mm)	Cena
71-601600 *		600	39,0	5,65	1,4	1900	700/900	3.075,99
71-801600 *		800	39,0	5,65	1,8	1880	790/990	3.139,18
71-101600 *		1000	48,0	6,95	1,8	2270	790/990	3.310,35
71-151600 *		1500	48,0	6,95	3,0	2665	900/1100	3.869,35
80-201600 *		2000	56,0	8,0	4,5	2500	1100/1300	4.774,84

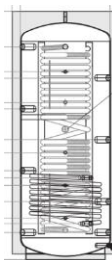

mehka izolacija

MULTI-INOX ZALOGOVNIK ZA SANITARNO VODO Z INOX IZMENJEVALCEM IN DVEMA IZMENJEVALCEMA



Koda	EAN	Volumen zalogovn. (l)	Volumen inox izmenjev.(l)	Izmenjev. sanitarne vode (m ²)	Izmenjev. spodnji / zgornji (m ²)	Višina (mm)	Premer brez / z izolacijo (mm)	Cena
72-601600 *	5901224326356	600	39,0	5,65	1,4 / 1,4	1900	700/900	3.236,54
72-801600 *		800	39,0	5,65	1,8 / 1,8	1880	790/990	3.318,16
72-101600 *		1000	48,0	6,95	1,8 / 1,8	2270	790/990	3.484,56
72-151600 *		1500	48,0	6,95	3,0 / 2,4	2665	900/1100	4.109,33
82-201600 *		2000	56,0	8,0	4,5 / 3,0	2500	1100/1300	5.073,61

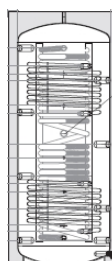

mehka izolacija

*Po naročilu

REFLEX N, RAZTEZNE POSODE ZA CENTRALNO OGREVANJE IN HLAJENJE, 4 bar - 120°C, siva

Koda	EAN	Naziv	Premer (mm)	Višina (mm)	Viš. priklj. (mm)	Teža (kg)	Priključek	Cena
8202501	4036705214462	Reflex N8/4	272	236		2,35	R3/4"	45,34
8203301	4036705086564	Reflex N12/4	272	317		2,75	R3/4"	48,10
8204301	4036705086618	Reflex N18/4	308	360		3,60	R3/4"	50,96
8206301	4036705032059	Reflex N25/4	308	477		4,35	R3/4"	62,32
8208401	4036705032066	Reflex N35/4	376	466	130	5,60	R3/4"	76,34

REFLEX N, RAZTEZNE POSODE ZA CENTRALNO OGREVANJE IN HLAJENJE, 6 bar - 120°C, siva

Koda	EAN	Naziv	Premer (mm)	Višina (mm)	Viš. priklj. (mm)	Teža (kg)	Priključek	Cena
8209300	4036705078590	Reflex N50/6	441	487	175	9,60	R3/4"	118,35
8210200	4036705078613	Reflex N80/6	512	558	172	13,28	R1"	182,76
8216300	4036705078637	Reflex N100/6	512	669	172	15,84	R1"	295,02
8211400	4036705078651	Reflex N140/6	512	890	172	19,90	R1"	336,79
8213300	4036705032394	Reflex N200/6	634	758	205	23,80	R1"	452,52
8214300	4036705110542	Reflex N250/6	634	888	205	24,70	R1"	598,30
8215300	4036705110108	Reflex N300/6	634	1092	235	30,00	R1"	696,50
8218000	4036705110139	Reflex N400/6	740	1102	245	47,00	R1"	870,63
8218300	4036705110153	Reflex N500/6	740	1321	245	52,00	R1"	1.044,32
8218400	4036705110177	Reflex N600/6	740	1531	245	66,00	R1"	1.561,26
8218500	4036705110191	Reflex N800/6	740	1996	245	96,00	R1"	1.874,55
8218600	4036705110207	Reflex N1000/6 *	740	2413	245	118,00	R1"	2.428,04

REFLEX S, RAZTEZNE POSODE ZA SOLARNE SISTEME 10 bar - 120°C

Koda	EAN	Naziv	Premer (mm)	Višina (mm)	Viš. priklj. (mm)	Teža (kg)	Priključek	Cena
8707700	4036705109973	Reflex S2/10 *	132	260		0,98	G3/4"	41,77
8703900	4036705109850	Reflex S8/10	206	332		1,80	G3/4"	65,02
8704000	4036705109874	Reflex S12/10	280	300		2,16	G3/4"	70,52
8704100	4036705040993	Reflex S18/10	280	409		2,95	G3/4"	76,53
8704200	4036705041006	Reflex S25/10	280	518		3,68	G3/4"	94,99
8706200	4036705057731	Reflex S33/10	354	455		4,80	G3/4"	130,15
8209500	4036705037115	Reflex S50/10	415	469	158	8,06	R3/4"	245,42
8210300	4036705110382	Reflex S80/10 *	486	562	166	12,10	R1"	266,30
8210500	4036705110399	Reflex S100/10 *	486	667	165	12,90	R1"	327,66
8211500	4036705110405	Reflex S140/10 *	486	886	172	19,05	R1"	608,48
8213400	4036705110412	Reflex S200/10 *	640	758	205	27,50	R1"	679,26
8214400	4036705110429	Reflex S250/10 *	640	888	205	32,40	R1"	946,53
8215400	4036705110436	Reflex S300/10 *	640	1092	235	47,00	R1"	1.127,17
8219000	4036705110443	Reflex S400/10 *	746	1102	245	61,00	R1"	1.293,03
8219100	4036705110450	Reflex S500/10 *	746	1321	245	72,00	R1"	1.578,25

TEHNIČNE LASTNOSTI REFLEX N

5-letna garancija za Reflex N raztezne posode

Za zaprte ogrevalne in hladilne sisteme. Z navojnim priključkom. Nad 35 litrov stoječa posoda, velikost pod N80 stenska montaža. Obratovalna temperatura: 70°C. Dovoljen delovni tlak 4bar (8-35 l); 6bar (50-140 l). Primerno za dodajnje protizmrazovalne tekočine koncentracije 25 - 50%. Odobreno po Direktivi o tlačni opremi (2014/68/EU). Zaščiteno z vzdržljivim epoxy premazom. Tovarniško preizkušena komora. Temperatura ogrete tekočine: 120°C.



*Po naročilu

REFLEX C, PLOŠČATE RAZTEZNE POSODE 3bar - 120°C (za več kot 50% protizmzovalne tekočine)



Stenske konzole vključene v ceno

Koda	EAN	Naziv	Debelina (mm)	Višina (mm)	Viš. priklj. (mm)	Teža (kg)	Premer (mm)	Priključek	Cena
8280000	4036705110245	Reflex C8/3 *	176	296	52	2,71	280	G1/2"	115,44
8280100	4036705110252	Reflex C12/3	182	370	64	3,60	354	G1/2"	120,66
8280200	4036705110269	Reflex C18/3	236	370	76	4,10	356	G3/4"	132,37
8280300	4036705110283	Reflex C25/3	253	427	93	5,10	409	G3/4"	150,82
8280400	4036705110290	Reflex C35/3	256	465	97	6,55	480	G3/4"	176,28
8280500	4036705110306	Reflex C50/3 *	332	465	125	8,00	480	G3/4"	234,19
8280600	4036705110313	Reflex C80/3 *	338	621	135	15,70	634	G3/4"	328,37

REFLEX G, RAZTEZNE POSODE Z MEMBRANO 6bar - 120°C



Koda	EAN	Naziv	Premer (mm)	Višina (mm)	Viš. priklj. (mm)	Teža (kg)	Priključek	Cena
8519000	4036705111129	Reflex G100/6 *	480	850	145	19,20	G1"	1.305,86
8519100	4036705111136	Reflex G200/6 *	634	967	144	36,50	G1 1/4"	1.513,32
8519200	4036705111143	Reflex G300/6 *	634	1267	144	41,60	G1 1/4"	2.012,24
8521605	4036705111204	Reflex G400/6 *	740	1276	146	43,00	G1"	2.299,89
8521705	4036705111235	Reflex G500/6 *	740	1494	146	51,00	G1"	2.668,99
8522605	4036705111297	Reflex G600/6 *	740	1739	146	66,00	G1"	2.956,63
8546605	4036705111532	Reflex G1000/6 *	740	2593	146	150,00	G1"	4.739,78
8527605	4036705110825	Reflex G2000/6 *	1200	2451	291	300,00	DN 65 / PN 6	14.253,70

REFLEX G, RAZTEZNE POSODE Z MEMBRANO 10bar - 120°C



Koda	EAN	Naziv	Premer (mm)	Višina (mm)	Viš. priklj. (mm)	Teža (kg)	Priključek	Cena
8518000	4036705110993	Reflex G100/10 *	480	850	146	19,2	G1"	1.482,77
8518100	4036705111020	Reflex G200/10 *	634	966	144	33,4	G1 1/4"	1.892,60
8518200	4036705111051	Reflex G300/10 *	634	1267	144	34,6	G1 1/4"	2.545,53
8521005	4036705111167	Reflex G400/10 *	740	1275	133	52	G1 1/4"	3.547,20
8521006	4036705111174	Reflex G500/10 *	740	1494	133	60	G1 1/4"	4.438,13

REFLEX V, VMESNA RAZTEZNA POSODA 10bar - 110°C

Koda	EAN	Naziv	Premer (mm)	Višina (mm)	Viš. priklj. (mm)	Teža (kg)	Priključek	Cena
8303100	4036705181092	Reflex V6/10 *	206	244	319	4	R 3/4"	87,88
8303400	4036705181122	Reflex V40/10 *	409	562	113	9,75	R1"	345,41
8303600	4036705181146	Reflex V200/10 *	634	901	142	35,25	DN 40 / PN 16	1.454,48

REFIX HW, RAZTEZNE POSODE ZA HIDROFOR 10bar - 70°C

Koda	EAN	Naziv	Dolžina / dolžina / d (mm)	Premer (mm)	Višina (mm)	Podstavek (mm)	Teža (kg)	Priključek	Cena
7200310	4036705106910	Refix HW 25/10	517,7 / 491 / 458	280	301	270	5,05	G 3/4"	78,32
7200320	4036705102288	Refix HW 50/10	503 / 476 / 440	409	432	350	9,00	G 1"	208,86
7200340	4036705102301	Refix HW 80/10	593 / 564 / 523	480	504	350	12,50	G 1"	426,13
7200350*	4036705102318	Refix HW 100/10	706 / 667 / 640	480	504	350	14,06	G 1"	476,69

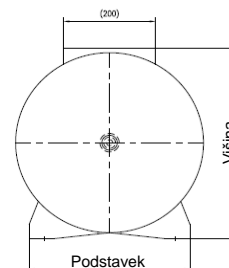
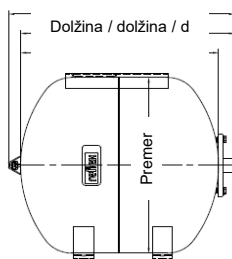

*Po naročilu

REFIX DD, PRETOČNE RAZTEZNE POSODE ZA SANITARNO VODO
10bar – 70°C

Koda	EAN	Naziv	Premer (mm)	Višina (mm)	Teža (kg)	Priključek	Cena
7381500	4036705082658	Refix DD2/10 *	132	269	0,98	G3/4"	118,86
7308000	4036705001406	Refix DD8/10	206	345	1,80	G3/4"	126,36
7308200	4036705001420	Refix DD12/10	280	318	2,20	G3/4"	135,01
7308300	4036705001437	Refix DD18/10	280	418	3,04	G3/4"	158,09
7308400	4036705001444	Refix DD25/10	280	528	3,80	G3/4"	188,67
7380700	4036705057779	Refix DD33/10	354	468	5,06	G3/4"	225,02

REFIX DT, PRETOČNE RAZTEZNE POSODE ZA SANITARNO VODO
10bar - 70°C + flowjet

Koda	EAN	Naziv	Premer (mm)	Višina (mm)	Viš. priklj. (mm)	Teža (kg)	Priključek-ventil (flowjet)	Cena
7309000	4036705001475	Refix DT60/10	409	766	80	15,00	Rp 1¼"	1.200,13
7309100	4036705001482	Refix DT80/10	480	750	17	17,00	Rp 1¼"	1.269,37
7309200	4036705001499	Refix DT100/10	480	834	19	19,20	Rp 1¼"	1.351,30
7309300	4036705001505	Refix DT200/10	634	973	80	37,00	Rp 1¼"	2.124,47
7309400	4036705001512	Refix DT300/10	634	1273	80	51,00	Rp 1¼"	2.329,87
7319305	4036705079382	Refix DT400/10	740	1245	69	74,00	Rp 1¼"	2.655,29
7309500	4036705001529	Refix DT500/10	740	1475	69	72,00	Rp 1¼"	2.791,46

REFIX DT, PRETOČNE RAZTEZNE POSODE ZA SANITARNO VODO
10bar - 70°C - 2 priključka

Koda	EAN	Naziv	Premer (mm)	Višina (mm)	Viš. priklj. (mm)	Teža (kg)	Priključek	Cena
7365400	4036705043512	Refix DT100/10 *	480	834	97	26,8	DN50/PN16	1.290,14
7365100	4036705039492	Refix DT200/10 *	634	973	105	53,00	DN50/PN16	2.076,00
7365200	4036705039508	Refix DT300/10 *	634	1273	105	59	DN50/PN16	2.288,33
7365500	4036705078217	Refix DT400/10 *	740	1245	80	80	DN50/PN16	2.613,75
7365300	4036705039515	Refix DT500/10 *	740	1475	90	88	DN50/PN16	2.759,15
7365600	4036705078224	Refix DT600/10 *	740	1859	233	164	DN50/PN16	6.110,29
7365700	4036705078231	Refix DT800/10 *	740	2324	233	204	DN50/PN16	7.173,10
7365800	4036705078248	Refix DT1000/10 *	740	2804	233	260	DN50/PN16	8.020,12
7335705	4036705079207	Refix DT80/10 *	480	750	107	24,70	DN65/PN16	1.235,91
7336505	4036705079399	Refix DT400/10 *	740	1245	105	81,00	DN65/PN16	2.624,14
7320105	4036705066887	Refix DT1000/10 *	1000	2001	160	386,20	DN65/PN16	8.516,33
7320305	40367050665798	Refix DT1500/10 *	1200	2001	158	502,40	DN65/PN16	11.229,32
7365406	4036705079245	Refix DT100/10 *	480	834	114	26,8	DN80/PN16	1.351,30
7365106	4036705079290	Refix DT200/10 *	634	973	120	57,00	DN80/PN16	2.124,47
7337205	4036705079603	Refix DT1000/10 *	1000	2001	160	386,20	DN80/PN16	8.084,74

REFIX DT, PRETOČNE RAZTEZNE POSODE ZA SANITARNO VODO
16bar - 70°C - 2 priključka

Koda	EAN	Naziv	Premer (mm)	Višina (mm)	Viš. priklj. (mm)	Teža (kg)	Priključek	Cena
7370200	4036705078279	Refix DT200/16 *	634	973	105	61	DN50/PN16	2.707,22
7370300	4036705078286	Refix DT300/16 *	634	1273	105	70	DN50/PN16	3.136,50
7370600	4036705078316	Refix DT600/16 *	740	1859	235	174	DN50/PN16	6.504,95
7370700	4036705078323	Refix DT800/16 *	740	2324	235	224	DN50/PN16	7.967,03
7370800	4036705078330	Refix DT1000/16 *	740	2804	235	275	DN50/PN16	9.130,24
7370102	4036705080265	Refix DT100/16 *	480	834	114	38	DN80/PN16	2.028,69
7370505	4036705079467	Refix DT500/16 *	740	1615	235	140	DN80/PN16	4.494,73

*Po naročilu

REFIX DE, RAZTEZNE POSODE ZA SANITARNO VODO
10bar - 70°C

Koda	EAN	Naziv	Premer (mm)	Višina (mm)	Viš. priklj. (mm)	Teža (kg)	Priključek	Cena
7200300	4036705072475	Refix DE2/10	132	260		0,98	G3/4"	55,61
7301000	4036705000584	Refix DE8/10	206	332		1,80	G3/4"	64,23
7302000	4036705000737	Refix DE12/10	280	310		2,16	G3/4"	67,94
7303000	4036705000836	Refix DE18/10	280	407		3,27	G3/4"	79,28
7304000	4036705000935	Refix DE25/10	280	518		3,75	G3/4"	93,99
7303900	4036705057793	Refix DE33/10	354	457		4,95	G3/4"	122,02
7306400	4036705001208	Refix DE60/10	409	734	161	10,50	G1"	317,21
7306500	4036705001215	Refix DE80/10	480	737	143	12,80	G1"	357,68
7306600	4036705001222	Refix DE100/10	480	852	143	14,80	G1"	386,23
7306700	4036705001239	Refix DE200/10	634	967	150	34,80	G1 1/4"	805,53
7306800	4036705001246	Refix DE300/10	634	1267	150	41,60	G1 1/4"	887,67
7306900	4036705001253	Refix DE500/10	740	1475	133	74,00	G1 1/4"	1.425,50
7311605	4036705066764	Refix DE1500/10	1200	1991	291	426,00	DN65/PN16	9.533,18
7311805	4036705066788	Refix DE3000/10	1500	2531	320	962,00	DN65/PN16	21.958,08

Z nezamenljivo membrano:

Koda	EAN	Naziv	Višina (mm)	Viš. priklj. (mm)	Premer (mm)	Priključek	Cena
7200400	4036705074110	Refix DC25/10 junior	510		289	G1"	119,62
7309600	4036705037245	Refix DC50/10 junior	588	115	418	G1"	201,61

REFIX WD MINI, PRETOČNA RAZTEZNA POSODA ZA SANITARNO VODO, 10bar – 70°C

Koda	EAN	Naziv	Premer (mm)	Višina (mm)	Teža (kg)	Priključek	Cena
7351000	4036705005374	Refix WD mini (za pralne stroje, plinske kotli	83	111	0,30	G 1/2"	79,42

SERVISNI VENTIL

Koda	EAN	Naziv	Cena
8770	8595222613357	Servisni ventil 3/4" za raztezne posode in kontrolo tlaka	28,92
7613000	4036705008108	Servisni ventil 3/4" za raztezne posode in kontrolo tlaka	79,42
7613100	4036705008115	Servisni ventil 1" za raztezne posode in kontrolo tlaka	110,61
12295	8595222633119	Servisni ventil 1" za raztezne posode in kontrolo tlaka	30,64
9116799	4036705066566	Servisni ventil 3/4" M/F za pretočne raztezne posode in kontrolo tlaka	45,58

DIGITALNI MERILNIK TLAKA

Koda	EAN	Naziv	Cena
9119198	4036705083143	Elektronski merilnik tlaka v raztezni posodi (max.9bar)	54,30

KONZOLA ZA RAZTEZNO POSODO

Koda	EAN	Naziv	Cena
KONEKS34	3830016900769	Konzola za raztezno posodo 3/4"	9,800
7610	3830016907614	Konzola za raztezno posodo 1"	11,050

PRITRDILNA OBJEMKA

Koda	EAN	Naziv	Cena
7611000	4036705008085	Objemka pritrdilna za raztezno posodo	19,62



OBTOČNA ČRPALKA

Koda	Naziv	Cena
AVANSA254180	AVANSA OBT.ČRPALKA 25-40-180	96,75
AVANSA256180	AVANSA OBT.ČRPALKA 25-60-180	105,16
AVANSA258180	AVANSA OBT.ČRPALKA 25-80-180	192,76
AVANSA326180	AVANSA OBT.ČRPALKA 32-60-180	108,34
AVANSA328180	AVANSA OBT.ČRPALKA 32-80-180	205,20

TEHNIČNE LASTNOSTI

	Avansa 25/4/180	Avansa 25/6/180	Avansa 25/8/180	Avansa 32/6/180	Avansa 32/8/180
Skupna dolžina	180mm	180 mm	130 mm	180 mm	180 mm
Vhod	38/53/72 W	93/67/46 W	182/170/145 W	93/67/46 W	150/210/1250 W
Dostava (m)	4	6	8	6	8
Dimenzije (cm)	13,5x19,5x14,5	13,5x19,5x14,5	19x16x15	19,5x14,5x13,5	19,5x14,5x15,5
Teža (kg)	2,7	2,8	4,5	3	3
DN dovod (mm)	25	25	25	32	32
DN izpust (mm)	25	25	25	32	32
Največji pretok (l/min)	48	55	115	55	160
Navoj povezave	6/4"	6/4"	6/4"	2"	2"

Največji delovni tlak: 10 bar
 Temperatura tekočine: od -10 do +110°C
 Zaščita: IP44
 Razred izolacije: FH
 Material: lito železo / plastika
 Napetost (V): 230



ELEKTRONSKA OBTOČNA ČRPALKA

Koda	Naziv	Cena
AVANSA254E180	AVANSA OBT.ČRPALKA 25-40-180E	183,73
AVANSA256E180	AVANSA OBT.ČRPALKA 25-60-180E	185,68
AVANSA326E180	AVANSA OBT.ČRPALKA 32-60-180E	188,12

TEHNIČNE LASTNOSTI

	Avansa 25/4/180E	Avansa 25/6/180E	Avansa 32/8/180E
Skupna dolžina	180 mm	180 mm	180 mm
Vhod	35 W	45 W	150/210/1250 W
Dostava (m)	4	6	6
Dimenzije (cm)	19,5x14,5x15,5	19,5x14,5x15,5	19,5x14,5x15,5
Teža (kg)	2,5	2,7	3,3
DN dovod (mm)	25	25	2"
DN izpust (mm)	25	25	2"
Največji pretok (l/min)	48	58	160
Navoj povezave	1"	6/4"	6/4"

Največji delovni tlak: 10 bar
 Temperatura tekočine: -10 až +110°C
 Zaščita: IP44
 Razred izolacije: FH
 Material: lito železo / plastika
 Napetost (V): 230
 Frekvenca: 50/60Hz

SET ZA TALNO OGREVANJE
Z NASTAVLJIVO TEMPERATURO 20-45°C

Koda	DN	Cena
104687G-F3-P6	1"	342,21

SET ZA TALNO OGREVANJE
S 3-POTNIM MEŠALNIM VENILOM

Koda	DN	Cena
104686-M3-C6	1"	264,91



MOTORNI POGON TRITOČKOVNI

Koda	Napetost	Cena
TRM20	230V	89,91



3-POTNI MEŠALNI VENTIL M za talno ogrevanje

Koda	DN	Cena
041036	1"M	48,98



3-POTNI MEŠALNI VENTIL F

Koda	DN	Cena
041055-10	1"F	49,39
051055-16	1 1/4"F	57,64



KROGELNI VENTIL S TERMOMETROM

Koda	navoj/matica/holandec	Cena
04550STER-(R/B)	1"/1 1/4"	25,10
05550STER-(R/B)	1 1/2"/1 1/4"	28,11
0555AMS-TER-(B/R)	1 1/4"/2"	31,47

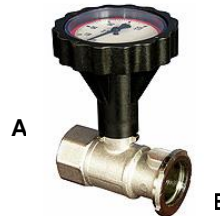

4-POTNI MEŠALNI VENTIL F

Koda	DN	Cena
041065-10	1"F	55,83
051065-16	1 1/4"F	63,61



KROGELNI VENTIL S TERMOMETROM Z NEPOVRATNO LOPUTO

Koda	DN	Cena
04550S/2TER-R	1"	27,98
05550S/2TER-R	1 1/4"	31,54



SET MATICE IN TESNILA

Koda	DN	Cena
AYHU26SET	1 1/4"	2,71
AYHT07SET	2"	6,11



KROGELNI VENTIL S PODALJŠANO ROČICO

Koda	DN	Cena
04550SISO	1"	20,51
05550SISO	1 1/4"	23,74



KROGELNI VENTIL S HOLANDCEM ZA VODOMER

Koda	DN	Cena
0328	1/2" x 3/4"	10,02



KROGELNI VENTIL S HOLANDCEM ZA VODOMER

Koda	DN	Cena
0319	3/4" x 1"	14,90



SERVISNI VENTIL ZA RAZTEZNO POSODO



Koda	DN	Cena
8770	3/4" M/F	15,81
EAN: 8595222613357		
12295	1" M/F	20,97
EAN: 8595222633119		

TERMIČNO VAROVALO za kotel s hladilnim krogom



Koda	Naziv	Cena
14478	BVTS 4m / 95°C 3/4"F	113,09
EAN: 8595222647918 tulka 140mm		

Termično varovalo proti pregretju kotla s hladilnim krogom fiksna kapilara 4m

REGULATOR VLEKA RT4



Koda	Naziv	Cena
13878	RT4	40,85
EAN: 8595222643910		

Regulator vleka za kotle na trda goriva

TERMIČNO VAROVALO za kotel s hladilnim krogom



Koda	Naziv	Cena
14477	BVTS 1,3m	76,86
EAN: 8595222647901 3/4"F		

95°C
tulka 140mm

Termično varovalo proti pregretju kotla s hladilnim krogom fiksna kapilara 1,3m

TERMIČNO VAROVALO DBV2



Koda	Naziv	Cena
16627	DBV2	131,76
v izolaciji		
EAN: 8595222663925 3/4"		
97°C		
Teža 0,8 kg		

Termično varovalo proti pregretju kotla brez hladilnega kroga

TERMIČNO VAROVALO s hladilnim krogom JBV-1P



Koda	Naziv	Cena
8877	JBV-1P	58,41
EAN: 8595222602054 3/4" / '97°C		

Termično varovalo proti pregretju kotla s hladilnim krogom

PLOŠČATI IZMENJEVALEC DV193-20E



Koda	Naziv	Cena
9548	20kW 1000 L/h	144,94
Priključek: 4 x 3/4" M		
Tlak: 29,4bar		
Izoliran, 20 inox plošč		
Max.temp.delovanja: 150°C		

Za ogrevanje vode v zalogovniku ali bazenu - kotli, sončno ogrevanje, toplotna črpalka

PLOŠČATI IZMENJEVALEC DV193-30E



Koda	Naziv	Cena
9549	30kW 1000 L/h	183,37
Priključek: 4 x 3/4" M		
Tlak: 29,4bar		
Izoliran, 30 inox plošč		
Max.temp.delovanja: 150°C		

Za ogrevanje vode v zalogovniku ali bazenu - kotli, sončno ogrevanje, toplotna črpalka

POTOPNA TULKA



Koda	Naziv	Cena
14880	za 1 tipalo	4,68
1/2"- 7 x 9 x 100		
14881	za 1 tipalo	8,55
1/2"- 7 x 9 x 200		
15744	za 3 tipala	5,06
1/2"- 13,5 x 16 x 100		
15743	za 3 tipala	9,62
1/2"- 13,5 x 16 x 230		
14882	za 4 tipala	5,38
1/2"- 15 x 17 x 120		

TEMPERATURNI MEŠALNI VENTIL TSV3B



Koda	Naziv	Temp./dim.	Cena
11281	DN25	55°C	68,73
EAN: 8595222624070 3 x 1"F			

TEMPERATURNI MEŠALNI VENTIL TSV5B



Koda	Naziv	Temp./dim.	Cena
11807	DN32	55°C	82,24
EAN: 8595222629471 3 x 5/4"F			
11808	DN32	65°C	82,24
3 x 5/4"F			

GRELEC za bojler / zalogovnik



Koda	Naziv	Cena
8939	Grelec 7,5kW	135,05

TERMOELEMENT za temperat. meš. ventil TSV3B, 5B



Koda	Naziv	Cena
12102	Termoelement za temperaturni mešalni ventil TSV3B, 5B, 45°C	39,97
12101	Termoelement za temperaturni mešalni ventil TSV3B, 5B, 55°C	39,97

ROČNA POLNILNA NAPRAVA z lijakom 600ml



Koda		Cena
15054	Za solarne sisteme	147,13

ROČNA POLNILNA NAPRAVA



Koda		Cena
15111	Za solarne sisteme	84,67

MEŠALNI VENTIL TSV-TV-MT52HC



Koda	*Odprodaja	Temp./dim.	Cena
7079		5/4" M, DN32 20-70°C	103,58

MEŠALNI VENTIL TSV1

Koda	*Odprodaja	Temp./dim.	Cena
8121		1" 45°C	46,24

ELEKTROMOTORNI VENTIL LK525 5/4" M 230V



Koda	*Odprodaja	Temp./dim.	Cena
12875		DN32 90°C	84,18

z aktuatorjem in kablom

11278	Adapter za pogone LK52	7,20
--------------	------------------------	-------------



TEMPERATURNI MEŠALNI VENTIL TSV6B



Koda	*Odprodaja	Temp./dim.	Cena
12975		DN40 55°C 3 x 6/4" F	54,79

ROTODIVERT



Koda	*Odprodaja	Temp./dim.	Cena
11285		DN32 80°C	74,30

Z aktuatorjem in kablom

TEMPERATURNI MEŠALNI VENTIL TSV8B



Koda	*Odprodaja	Temp./dim.	Cena
12978		DN50 55°C 3 x 2" F	71,98

HOLANDEC MS za TSV



Koda	*Odprodaja	Cena
6549	1"	3,72
6552	2"	12,08
65528	6/4"	12,08
12700	Cu28 x 5/4" (set 3)	8,91

TEMPERATURNI MEŠALNI VENTIL TSV5



Koda	*Odprodaja	Temp./dim.	Cena
11804		DN32 65°C 3 x 5/4" F	42,58

SOLARNI SKLOP S1 RS25/6



Koda	*Odprodaja	Cena
9047	2-12L/min 3/4"	193,98

TEMPERATURNI MEŠALNI VENTIL TSV6



Koda	*Odprodaja	Temp./dim.	Cena
11821		DN40 65°C 3 x 6/4" F	54,41

TIPALO KOLEKTORJA TSK 10 D1



Koda	*Odprodaja	Cena
1818		11,96

SOLARNI REGULATOR UR1 A-DT z dvema tipaloma



Koda	*Odprodaja	Cena
14159		172,02

VARNOSTNI VENTIL SOLAR



Koda	*Odprodaja	DN	Cena
02690-03		1/2" x 3/4"	6,83

GRELEC za bojler / zalogovnik



Koda	*Odprodaja	Cena
8930	Grelec 2kW 6/4" 3F	169,58



SERIJA SMART HOME

Koda *Po naročilu Naziv EAN: 5060103697670 Cena

SQ610 * Podometni žič./brezžič. sobni termostat Quantum, bel, deb.11mm **158,60**

Podometni večfunkcijski termostat s senzorjem vlage za: -brezžično krmiljenje naprav iz serije SMART HOME preko aplikacije in internetnega prehoda UGE600, -žično krmiljenje naprav (žični priključni modul, kotel) - offline (brez povezave z internetom) preko enote CO10RF Senzor vlage, univerzalni vhod (senzor temperature, senzor zasedenosti, onetouch), zaščita ventilov, možnost zaklepa PIN in omejitve temperature, funkcije časovni načrt in warm floor, poveča pokritost Zig-bee omrežja. Napajanje 230V AC 50Hz, temperaturna natančnost 0,5-0,1°C; delovna temperatura 0-45°C, zaščita IP30, dimenzije 86x86x28mm, nadometna debelina 10mm.

Koda Naziv EAN: 5060103697687 Cena

SQ610RF Nadometni brezžični sobni termostat Quantum, bel, deb.11mm **158,60**

Podometni večfunkcijski termostat s senzorjem vlage in vgrajenim akumulatorjem za brezžično krmiljenje Senzor vlage, univerzalni vhod (senzor temperature, senzor zasedenosti, onetouch), zaščita ventilov, možnost zaklepa PIN in omejitve temperature, funkcije časovni načrt in warm floor, poveča pokritost Zig-bee omrežja. Napajanje 230V AC 50Hz, temperaturna natančnost 0,5-0,1°C; delovna temp. 0-45°C, zaščita IP30, dim. 86x86x28mm, nadometna debelina 10mm.

Koda *Po naročilu Naziv EAN: 5060103692330 / 5060103692323 Cena

VS10WRF Podometni brezžični sobni termostat, bel **134,44**

VS10BRF * Podometni brezžični sobni termostat, črn **134,44**

Omogoča krmiljenje priključnega modula KL10RF/KL08RF (ogrevanje/hlajenje), termostatske glave TRV, modula RX10RF in drugih Smart Home naprav preko aplikacije in internetnega pregoda UGE600, ali brez povezave z internetom preko enote CO10RF. Časovni načrt: 3 nastavljive temperature, ročni, počitniški način, časovnik za toplo vodo. Vhod za dodatni senzor temp. (tal, zraka) ali senzor zasedenosti. Napajanje 230V AC 50Hz, temperaturno območje 5 - 35°C, temperaturna natančnost 0,5°C, temp. diferenca ±0,25°C ±0,5°C, komunikacija brezžična ZigBee 2.4 Ghz, dim.: 86x86x42mm. Podometna doza ø60. 5-letna garancija.

Koda *Po naročilu Naziv EAN: 5060103692354 / 5060103692347 Cena

VS20WRF Brezžični sobni termostat, baterijsko napajanje, bel **134,44**

VS20BRF * Brezžični sobni termostat, baterijsko napajanje, črn **134,44**

Omogoča krmiljenje priključnega modula KL10RF/KL08RF (ogrevanje/hlajenje), termostatske glave TRV, modula RX10RF in drugih Smart Home naprav preko aplikacije in internetnega pregoda UGE600, ali brez povezave z internetom preko enote CO10RF. Časovni načrt: 3 nastavljive temperature, ročni, počitniški način, časovnik za toplo vodo. Vhod za dodatni senzor temperature (tal, zraka) ali senzor zasedenosti. Napajanje 4 x AAA baterije, temperaturno območje 5 - 35°C, temp. natančnost 0,5°C, histereza ±0,25°C ±0,5°C, komunikacija brezžična ZigBee 2.4 Ghz, dim.: 86x86x29mm. 5-letna garancija.

Koda Naziv EAN: 5060103692682 Cena

KL08RF Priključni brezžični modul, 8 con, talno ogrevanje **278,04**

Modul deluje s termostati SmartHome preko aplikacije in internetnega pregoda UGE600, ali offline preko enote CO10RF. Brezžična komunikacija, Zigbee 2,4GHz. Za 8 kontrolnih območij, 24 izhodov za povezavo pogonov (3 pogoni na cono). Vhodi: sprememba načina ogrevanje/hlajenje, senzor rosišča. Krmilni izhodi za črpalko in kotel. Združljivo s termostati VS10RF/VS20RF, termostati HTR-RF(20), HTRS-RF(30), HTRP-RF(50), temp. senzorjem TS600, sistemskim oddajnikom RX10RF. Dim.: 353x85x67mm. Opcija: dodatna antena za povečanje RF območja. Napajanje 230V AC 50Hz. Izhodi za pogone: 230V. Garancija 5 let.

Koda *Po naročilu Naziv EAN: 5060103692675 Cena

KL04RF * Dodatni priključni brezžični modul za KL08RF, 4 cone **71,98**

Modul za nadgradnjo KL08RF za dodatna 4 kontrolna območja, preklap ogrevanje/hlajenje. Napajanje 230V. Izhod: 230V. Dimenzije 170 x 85 x 67mm. Garancija 5 let.

Koda Naziv EAN: 5060103694457 Cena

TS600 Brezžični sobni senzor s funkcijo termostata, baterijski **65,88**

Brezžični nadometni senzor / programski termostat je preko aplikacije združljiv z napravami iT600RF sistema: KL10RF/KL08RF- brezžični priključni modul za talno ogrevanje, TRV- digitalna termostatska glava, RX10RF- sprejemnik za kotel (brezžični krmilni modul), SR600-programabilen rele, SPE600- programabilen električni priključek. Deluje samo v povezavi z univerzalnim prehodom UGE600. Napajanje: 2xAA bateriji, natančnost prikaza temperature (v aplikaciji) 0,5°C, histereza ±0,25°C ±0,5°C. Brezžični signal: ZigBee 2.4 GHz, temperaturno območje: 5-35°C. Dimenzije 51x85x26mm.

Koda Naziv EAN: 5060103692279 Cena

RX10RF Brezžični sprejemnik (samo ena enota na posamezni sistem) **98,82**

Krmilni modul je izvršilni element sistema SmartHome, ki se vključuje, ko prejme signal s termostata. Je alternativa žični povezavi med kotlom in KL08RF priključnim modulom. V sistemu s TRV10RFM glavami je opcijski element za zagon vira toplote. Lahko deluje kot sprejemnik za en termostat (tip RX2) ali skupine termostatov (tip RX1). Napajanje 230V AC 50Hz, maksimalna obremenitev 16 (5)A, izhodni signal rele NO/COM, brezžični komunikator ZigBee 2.4GHz. Dimenzije: 145x100x35mm. Garancija 5 let.

Koda Naziv EAN: 5060103693269 / 5060103693474 Cena

TP10 Zaščita za termostatsko glavo TRV10RAM (javni prostori) **15,25**

TP28-30 Zaščita za termostatsko glavo TRV10RFM / TRV28RFM (javni prostori) **15,25**

Zaščita pred poseganjem in krajo. V setu: A objemka M30x1,5, B objemka M28x1,5, vijak, imbus ključ.



SERIJA SMART HOME

Koda	*Po naročilu Naziv	EAN: 5060103692903	Cena
TRV10RAM *	TRV brezžična termostatska radiatorska glava (Danfoss RA)		100,65

Za nadzor radiatorskega ogrevanja, v povezavi z brezžičnim termostatom preko enote CO10RF ali internetnega prehoda UGE600 (ni priloženo), možnost krmiljenja do 6 glav z enim termostatom. Združljivo s termostati VS10RF/VS20RF, HTRS-RF(30), HTRP-RF(50), TS600, priključnim žičnim modulom KL10RF, sprejemnikom RX10RF. Za Danfoss RA ventile. Napajanje 2 x AA baterije. Dimenzije: 52x85mm. Garancija 5 let.

Koda	Naziv	EAN: 5060103692743	Cena
TRV10RFM	TRV brezžična termostatska radiatorska glava (univerzalna)		100,65

Za nadzor radiatorskega ogrevanja, v povezavi z brezžičnim termostatom preko enote CO10RF ali internetnega prehoda UGE600 (ni priloženo), možnost krmiljenja do 6 glav z enim termostatom. Združljivo s termostati VS10RF/VS20RF, HTRS-RF(30), HTRP-RF(20), HTRP-RF(50), TS600, priključnim žičnim modulom KL10RF, sprejemnikom RX10RF. Za ventile Danfoss RA, TA Heimeier, Honeywell, Oventrop. Priključek M30 x 1,5. Napajanje 2 x AA baterije. Dimenzije: 52x85mm. Garancija 5 let.



SERIJA SMART HOME (iT600RF)

Koda	Naziv	EAN: 5060103693252	Cena
UGE600	Univerzalni internetni prehod ZigBee		187,15

Omogoča koordinacijo naprav SmartHome s krmiljenjem preko telefona ali računalnika z uporabo aplikacije. Napajanje: 5V DC preko USB. ZigBee 2.4Ghz. Delovna temperatura 0-50°C. Omogoča povezavo do 100 oz. do 32 naprav, če so vse na baterijsko napajanje. Napajanje 5V DC, Port 1 x 10/100 LAN port, priložen LAN-kabel in napajalnik. Dim.: višina 55,5mm, ø90mm.



Koda	Naziv	EAN: 5060103693184	Cena
SPE600	Pametni priključek		88,33

Nadzor prek pametnega telefona ali računalnika z uporabo aplikacije SALUS Smart Home, v povezavi z univerzalnim vhodom UGE600. Meri moč priključenih naprav, zaščita pred prekomerno obremenitvijo, programabilen urnik v aplikaciji SmartHome, deluje kot ponavljalnik za omrežje ZigBee, LED indikator, razširitev ZigBee signala. Maksimalna obremenitev 16A. Dim. 42x77x42mm.

Koda	Naziv	EAN: 5060103694167	Cena
RE600	Repetitor ZigBee - ojačevalac signala		68,32

Repetitor RE600 poveča obseg omrežja ZigBee, v primeru motenj med posameznimi napravami. Online: v povezavi z univerzalnim sprejemnikom UGE600 (naprodaj posebej) in aplikacijo SmartHome, offline s koordiniranjem CO10RF. Napajanje 230V AC 50Hz. Dim. 45x45x20mm.



Koda	Naziv	EAN: 5060103694143	Cena
SR600	Pametni rele (z S1/S2 komunikacijskima kontaktoma)		60,63

Daljinski rele za napetostne naprave (kotli, črpalke, ventili, pogoni, osvetlitev - 230V), za breznapetostne naprave (alarm, krmilniki vrat, senzor odpiranja), deluje kot ponavljalnik - poveča ZigBee območje, ali kot pametni vhod sistema, programabilen urnik v aplikaciji. Uporaba z UGE600 vhodom in Salus Smart Home aplikacijo. Napajanje 230V AC 50Hz, maksimalna obremenitev 16 (5)A, vhod S1, S2 izhodni signal rele NO/COM, brezžična komunikacija ZigBee 2.4GHz. Dimenzije: 45x45x20mm.



Koda	Naziv	EAN: 5060103697144	Cena
RS600	Krmilnik za rolete in osvetlitev		64,66

Upravljanje s stenskim roletami, zavesami ali osvetlitvijo z maksimalno obremenitvijo 5 A. Možno namestiti v dozi ali ohišju SRS600. Deluje kot ponavljalnik - poveča ZigBee območje. Naprava je tovarniško pripravljena za krmiljenje pogonov 230 V AC, razširitev ZigBee signala. Napajanje 230V AC 50Hz, maksimalna obremenitev 5(2)A, vhod in izhod S1, S2: 230V AC 50Hz. Brezžična komunikacija ZigBee 2.4GHz. Dimenzije: 45x45x20mm.



Koda	Naziv	EAN: 5060103697731	Cena
PS600	Brezžično temperaturno tipalo		72,47

Temperaturno tipalo PS600 omogoča krmiljenje izdelkov priključenih na pametne vtičnice SPE600 ali releje SR600, npr. črpalke, ventilov, pogonov. Veliko merilno območje tipala je zelo pomembno, ker zagotavlja široko področje uporabe za sisteme ogrevanja, hlajenja, nadzorovanja temperatur ali aktiviranja dogodkov/pravil OneTouch v okviru sistema. Za pravilno delovanje senzorja sta potrebna internetni prehod UGE600 in aplikacija SALUS Smart Home. Senzor za namestitev na cev 15-18mm, odstranljiva sponka omogoča namestitev tipala npr. v kabelski cevi, izklopi črpalke, ko temperatura pade pod 25°C. Merilno območje -50 do 100°C. Napajanje 1xCR2, brezžična komunikacija ZigBee 2.4GHz, dolžina kabla 470mm. Dim.: 73,5x24,7x20mm.



Koda	Naziv	EAN: 5060103694440	Cena
SW600	Senzor okna / vrata, tanka izvedba		79,06

Brezžični senzor za kontrolo ogrevanja pri odprtih oknih / vratih z aplikacijo (izklopljene luči in termostati, obveščanje preko e-mail, SMS). Uporaba z UGE600 in Salus Smart Home aplikacijo. Napajanje: 1 x CR2 3V akumulator. Signal Zigbee 2.4Ghz. Delovna temperatura: 0-40°C. Dimenzije: Senzor š=22mm, v=70mm, g=20mm, Magneti: š=11mm, v=41mm, g=10mm



Koda	Naziv	EAN: 5060103697083	Cena
WLS600	Tipalo izliva vode		75,64

Tipalo je zasnovano z namenom zaznave prisotnosti vode na površini pod tipalom ali na kabljih, ki so povezani s tipalom. Namesti se lahko vodoravno ali navpično. Povezava z aplikacijo omogoča prejetje brezplačnih obvestil v primeru puščanja ali poplave (SMS, e-mail). Popolno odporen na vodo, različne vrste sestavljanja (dodatki vključeni). Napajanje 1 x CR2, komunikacija brezžična ZigBee, dolžina zunanega senzorja 2m, dim. viš. 25mm, ø55mm, ohišje 60x66x30mm.





SERIJA SMART HOME (IT600RF)

Koda	Naziv	EAN: 5060103698783	Cena
DI600	Krmilnik razsvetljave s funkcijo zatemnjevanja (dimmer)		79,54

Naprava je namenjena upravljanju z razsvetljavo. Ima funkcijo uravnavanja intenzitete razsvetljave (dimmer). Možnost daljnega vklopljanja/izklopljanja razsvetljave ter zatemnjevanja na podlagi brezžične komunikacije, in lokalnega upravljanja z uporabo vgrajenega stikala za luč. Deluje skupaj z internetnim prehodom UGE600 in aplikacijo SALUS Smart Home. Montaža se v stikalno omarico. Stikalo za vklop napajanja razsvetljave, uravnavanje intenzitete svetlosti, deluje kot repeater omrežja ZigBee, ima nastavljen urnik v aplikaciji SALUS Smart Home. Napajanje: 230V AC 50Hz. Maks. obremenitev: 1,5 A. Maks. moč svetlobnih virov: LED 200W halogen 400W. Komunikacija: brezžična ZigBee 2,4 GHz. Mere [mm]: 45,5 x 45 x 20,3.

Koda	Naziv	EAN: 5060103696956	Cena
SD600	Detektor dima		71,98

Uporablja se za zaznavo prisotnosti dima v realnem času. Detektor je možno uporabljati kot samostojno enoto (brez internetnega prehoda UGE600). Obvešča o zaznanih grožnjah (zvočni in svetlobni alarm), sinhroniziran z internetnim prehodom UGE600 in aplikacijo SALUS Smart Home, omogoča sprotno obveščanje o stanju (SMS in e-mail), za hotele, skladišča). Napajanje 1 x CR2, komunikacija brezžična ZigBee, raven hrupa <85dB, delovna temp. -10-50°C, dim. 60x60x49mm.

Koda	Naziv	EAN: 5060103698097	Cena
MS600	Brezžični senzor gibanja		83,08

Brezžični senzor za zaznavanje gibanja. Za pravilno delovanje senzorja sta potrebna internetni prehod UGE600 in aplikacija SALUS SmartHome. Preko aplikacije lahko na daljavo spremljamo prisotnost oseb v prostoru in prejmemo obvestila SMS/e-mail. OneTouch lahko napravam, kot sta SPE600 ali SR600, senzor gibanja vklopi/izklopi katero koli električno napravo, (luči, ko zazna prisotnost na stopnicah, ali gibanje v kopalnici). Odporen proti živalim do 35kg. Napajanje 1 x CR2, komunikacija brezžična ZigBee 2,4GHz, območje detekcije 8m, kot zaznavanja gibanja 80°, dim. 60,45 x 80,52 x 43,18mm.

Koda	Naziv	EAN: 5060103693665	Cena
SB600	Pametni gumb, baterijsko napajanje		55,39

Brezžični, za aktiviranje dveh različnih OneTouch pravil, aktivira po dva dogodka, npr. izklop ogrevanja, vklop urnika, vklop osvetlitve (brez prehoda in aplikacije). Obveščanje preko SMS ali e-mail. Napajanje 2 x AAA baterije, komunikacija brezžična ZigBee 2,4GHz, dim. 59 x 19 x 19mm.

Koda	Naziv	EAN: 5060103693658	Cena
FC600	Brezžični sobni termostat za konvektorje, bel		150,06

Za krmiljenje 2- in 4-cevnih ventilatorskih stenskih konvektorjev, talnih konvektorjev ali grelnikov vode z vgrajenim ventilatorjem. Krmili ventilator in ventila za vzdrževanje željene temperature. Deluje z internetno povezavo s prehodom UGE600 in aplikacijo SmartHome. Nastavljen kot dnevni termostat z možnostjo tedenskega načina. razširi ZigBee območje. Napajanje 230V AC 50Hz, brezžična komunikacija ZigBee 2,4GHz. Max. obremenitev 5(2)A, krmilni izhodi (hitrosti in pogon) 230V AC 50Hz, razpon nastavljene temperature 5-40°C, natančnost prikaza temperature 0,1...0,5°C. Dim.: 86 x 86 x 46mm, nadometna debelina 16,5mm.

Koda	*Po naročilu Naziv	EAN: 5060103694587	Cena
FC600-M 0-10V *	Modul za ventilatorje		89,06

Modul za ventilatorske konvektorje, talne konvektorje ali grelnike z ventilatorji na signal 0-10V. Dopolnjuje glavni termostat FC600. Upravlja hitrost ventilatorja z EC motorjem - določa napetost od 0 - 10V. Upravlja dva električna pogona (ventil ogrevanja in hlajenja), pretvarja signal 230V AC /24V DC. Napajanje 24V DC. Vhodi (230V AC): F1, F2, F3 - nizki, srednji, visoki tek ventilatorja; V1, V2 - pogoni ventilov ogrevanje in hlajenje. Izhodi: napajanje ventilatorja 24V DC, 6,5A; krmiljenje ventilatorja 0...10V; pogoni za ventila ogrevanje/hlajenje 24V DC, 1A. Namestitve: rele DIN 35mm. Dimenzije 51x90x65mm.

SERIJA SMART HOME HTR - brezžični sistem

Koda	Naziv	EAN: 5060103694402	Cena
HTR-RF20	Brezžični elektronski sobni termostat, baterijski		65,88

Sobni termostat, nadometni, v povezavi s KL08RF regulira talno gretje, ali se povezuje z iT600RF napravami preko ZigBee signala (2,4 GHz). Precizno ohranja temperaturo (algoritem TPI), lahko se priključi v vsaki fazi naložbe, ima funkcijo ustvarjanja časovnih načrtov. Omogoča nadzor preko interneta z aplikacijo Smart Home in prehodom UGE600. V Offline načinu preko enote CO10RF deluje kot dnevni termostat. Območje temp. 5°C - 32,5°C, napajanje 2 x AA baterije, dim. 80 x 85 x 32,5 mm.

Koda	Naziv	EAN: 5060103694273	Cena
HTRS-RF30	Brezžični digitalni sobni termostat, dnevni, baterijski		96,38

Nadometni dnevni sobni termostat. Brezžična komunikacija ZigBee 2,4GHz preko aplikacije SmartHome in prehoda UGE600. Offline deluje preko enote CO10RF (kot dnevni termostat). Funkcije ustvarjanja časovnih načrtov, nočni način, opcijsko talni senzor. Precizno ohranja temperaturo-algoritem TPI, vhod za dodatni senzor temp. tal ali zraka. Temp. območje 5-35°C, napajanje 2 x AA baterije, natančnost prikaza temp. 0,5°C, komunikacija ZigBee 2,4GHz, dim. 80 x 85 x 25mm.

Koda	Naziv	EAN: 5060103694280	Cena
HTRP-RF50	Brezžični digitalni termostat, za talno ogrevanje, baterijski		105,41

Nadometni dnevni termostat za talno ogrevanje za priključni modul KL08RF, glava TRV in krmilni modul RX10RF. Brezžična komunikacija ZigBee 2,4GHz preko aplikacije SmartHome in prehoda UGE600. Offline deluje preko enote CO10RF (kot dnevni termostat). Časovni načrt, nočni način, opcijsko talni senzor. Precizno ohranja temperaturo-algoritem TPI, vhod za dodatni senzor temp. tal ali zraka. Temp. območje 5-35°C, napajanje 2 x AA baterije, natančnost prikaza temp. 0,5°C, komunikacija ZigBee 2,4GHz, dim. 80 x 85 x 25mm. 5 let garancije.



SERIJA SMART HOME HTR - brezžični sistem

Koda	Naziv	EAN: 5060103693368	Cena
ECM600	Merilnik električne energije		195,20

Zaznava 1 ali 3 faze, v enofaznem načinu lahko meri skupno porabo ali 3 ločene porabnike. Deluje preko aplikacije SmartHome in prehoda UGE600. Temp. območje -10-50°C, napajanje 4 x AA baterije, komunikacija ZigBee 2,4GHz, dim. 120 x 110 x 38mm. 5 let garancije.

Koda	Naziv	EAN: 5060103692750	Cena
08RFA	Zunanja antena za modul KL08RF / KL10RF		25,86

Za ojačitev signala pri veliki razdalji za priključna modula KL08RF in KL10RF z ostalim IT600 sistemom preko ZigBee signala. Dimenzije višina 131mm, ø29mm, dolžina kabla 100cm, namestitev magnet, vtič SMA-K.

Koda	Naziv	EAN: 5060103694150	Cena
SRS600	Stensko ohišje za montažo SR600/RS600/RE600		11,22

Nadomestno ohišje za repetitor RE600 ali podometni rele SR600 za zaščito pred izvlekom kablov in zunanjim poškodovanjem.

SERIJA EXPERT NSB

Koda	Naziv	EAN: 5060103698752	Cena
CB500	Priključni modul za talno ogrevanje (5 conski)		112,00

CB500 je glavni element za krmiljenje talnega ogrevanja ali hlajenja. Z montažo dodatnih enot se lahko številno neodvisnih temperaturnih con poveča. Upravlja do 15 temperaturnih con (priključni modul CB500 + dva razširitvena modula CB500X). Breznapetostni izhodi za krmiljenje kotla, toplotne črpalke ali hladilnega sistema. Preklop med načinom ogrevanja in hlajenja. Krmilna omarica je zasnovana za montažo NC (normalno zaprtih) pogonov. Nadzor 5 neodvisnih temperaturnih območij, nadzor toplotne črpalke, krmiljenje ogrevanja ali hlajenja, napredni krmilniki za kotel, hlajenje in toplotno črpalke. Enostavna montaža vodnikov z vzmetnimi sponkami, varovanje pred nezaželenim izvlekom, montaža na steno ali DIN letev. Napajanje 230V AC, 50Hz, maks. obremenitev 7A. Vhodi: preklop ogrevanje / hlajenje breznapetostni, tipalo rosišča. Izhodi: krmiljenje kotla breznapetostni, nadzor toplotne črpalke / hlajenje breznapetostni, krmiljenje črpalke (AC 230V), pogoni (AC 230V). Dimenzije [mm] 270 x 110 x 55.

Koda	Naziv	EAN: 5060103698776	Cena
CB500X	Razširitveni modul talnega ogrevanja (5 conski)		85,64

CB500X je krmilni element talnega ogrevanja ali hlajenja, namenjen krmiljenju virov ogrevanja in hlajenja. Omogoča neodvisno nadzorovanje 5 temperaturnih con. Na obstoječi priključni modul CB500 lahko povežete največ 2 razširitvena modula CB500X in s tem upravljate 15 temperaturno neodvisnih con, ter vira ogrevanja in hlajenja. Vzmetne sponke za enostavno povezavo ožičenja. Krmilna omarica je zasnovana za montažo NC (normalno zaprtih) pogonov. Varovanje vodnikov pred nezaželenim izvlekom, kompatibilnost s priključnim modulom CB500, montaža na steno ali DIN letev. Napajanje 230V AC, 50Hz. Maks. obremenitev 1A. Izhodi: pogoni (AC 230V). Dimenzije [mm] 270 x 110 x 55.

Koda	Naziv	EAN: 5060103692552	Cena
VS30W	Žični programski termostat		98,82

Podometni termostat nadzira površinsko ogrevanje in hlajenje. Deluje s priključnim modulom KL08NSB ali KL06-M (230V). Sodeluje s pogoni NC ali NO. Za zaščito pred previsoko ali prenizko temp. se uporablja dodatni talni senzor FS300. Funkcije časovnih načrtov, krmili dnevne termostate, nočni in varčni način in zaščita pred zmrzovanjem. Ščiti termostatične ventile VP. Napajanje 230V AC 50Hz, maksimalna obremenitev 3A, krmilni izhodi (hitrosti in pogon) 230V AC 50Hz, razpon nastavljene temperature 5-35°C, natančnost prikaza temperature 0,5°C, žična komunikacija. Dimenzije: 86x86x42mm, podometna doza ø60 mm.

SERIJA EXPERT HTR

Koda	Naziv	EAN: 5060103693344	Cena
HTRP230(50)	Žični sobni digitalni termostat, tedenski, bel		72,47

Podometni termostat nadzira površinsko ogrevanje in hlajenje. Deluje s priključnim modulom KL08NSB ali KL06-M (230V). Sodeluje s pogoni NC ali NO. Za zaščito pred previsoko ali prenizko temp. se uporablja dodatni talni senzor FS300. Funkcije časovnih načrtov, krmili dnevne termostate, nočni in varčni način in zaščita pred zmrzovanjem. Ščiti termostatične ventile VP. Napajanje 230V AC 50Hz, maksimalna obremenitev 3A, krmilni izhodi (hitrosti in pogon) 230V AC 50Hz, razpon nastavljene temperature 5-35°C, natančnost prikaza temp. 0,5°C, žična komunikacija. Dim.: 85x85x25mm, podometna doza ø60 mm.

Koda	Naziv	EAN: 5060103693377	Cena
HTRS230(30)	Žični sobni digitalni termostat, dnevni, bel		61,98

Podometni termostat nadzira površinsko ogrevanje in hlajenje. Deluje s priključnim modulom KL08NSB ali KL06-M (230V). Sodeluje s pogoni NC ali NO. Za zaščito pred previsoko ali prenizko temp. se uporablja dodatni talni senzor FS300. Preko modula zniža določeno temperaturo, ko prejme signal NSB iz tedenskega termostata. Zaščita pred zmrzovanjem. Ščiti termostatične ventile VP. Napajanje 230V AC 50Hz, maksimalna obremenitev 3A, krmilni izhodi (hitrosti in pogon) 230V AC 50Hz, razpon nastavljene temperature 5-35°C, natančnost prikaza temp. 0,5°C, žična komunikacija. Dim.: 85x85x25mm, podometna doza ø60 mm.

REGULACIJA TALNEGA OGREVANJA EXPERT

Koda	Naziv	EAN: 4047795600004	Cena
KL06-M 230V	Priključni žični modul, 6 con, talno ogrevanje		71,25

Modul za talno ogrevanje. Za 6 kontrolnih območij, 24 izhodov za povezavo pogonov (4 pogoni na cono). Z moduli PL06/PL07 (nista vključena) lahko krmili obtočno črpalke in bojler. Povezava z vtičakom z razbremenitvijo. Deluje v povezavi s pogoni NC. Breznapetostni vklop boilerja in črpalke. Dim.: 300x86x60mm. Napajanje 230V AC 50Hz. Najvišja obremenitev 2(1)A. Izhodi za pogone: 230V AC 50Hz.



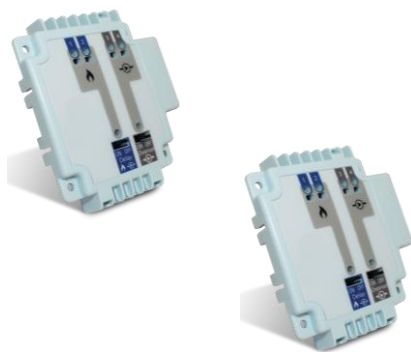

REGULACIJA TALNEGA OGREVANJA EXPERT

Koda	Naziv	EAN: 4047795600004	Cena
PL06-QL	Modul za črpalko ali kotel (za KL06)		29,04

Za krmiljenje obtočne črpalke in kotla prek breznapetostnih kontaktov NC/COM/NO. Izhod COM/NO se zapre, ko katerikoli kontakt povprašuje po toploti. Odpre se, ko termostati nehalo signalizirati potrebo po ogrevanju. Možnost izbire con, združljiv s priključnimi moduli KL06 za 230V in 24V. Napajanje prek KL06, najvišja obremenitev 5(2)A, izhodni signal NO/COM/NC, dim. 60x80x20mm.

Koda	Naziv	EAN: 4047795640000	Cena
PL07-QL	Modul za krmiljenje kotla in črpalke KL06		47,46

Za krmiljenje obtočne črpalke in kotla individualno prek breznapetostnih kontaktov NC/COM/NO. Izhod COM/NO se zapre, ko katerikoli kontakt povprašuje po toploti. Odpre se, ko termostati nehalo signalizirati potrebo po ogrevanju. Združljiv s priključnimi moduli KL06 za 230V in 24V. Napajanje prek KL06, najvišja obremenitev 5(2)A, izhodni signal 2 x rele NO/COM/NC, dim. 60x80x20mm.

Koda	Naziv	EAN: 4047795110008	Cena
RT10-230V	Žični dnevni sobni termostat, elektronski		27,69

Podometni termostat nadzira površinsko ogrevanje in hlajenje. Preko žičnega modula zniža določeno temperaturo, ko prejme signal NSB iz tedenskega termostata. Napajanje 230V AC 50Hz, maksimalna obremenitev 3A, krmilni izhodi (hitrosti in pogon) 230V AC 50Hz, razpon nastavljene temp. 5-30°C, natančnost prikaza temperature 0,5°C, žična komunikacija. Dimenzije: 85x85x30mm, podometna doza ø60 mm.

DODATNA OPREMA ZA TALNO OGREVANJE

Koda	Naziv	EAN: 5903669087311	Cena
RM-16A	Relejni modul 16A (napetostni / breznapetostni kontakt)		26,84

Modul za vklop/izklop električnih naprav. Krmiljene ogrevalne naprave (tipa ON/OFF) s priklopom na rele termostata 230V AC iz serije EXPERT NSB, HTR, BTR, HTRP/BTRP. Krmiljenje trajnožarečega kotla (ki zahteva kontakt NO/COM) s priklopom na relejni modul RM-16A termostata z izhodom COM/NO (npr. T105). Povezava sprejemnika z večjo močjo od tiste, ki jo dovoljuje rele v termostatu. Najvišja tokovna poraba ne sme presežati 16A. Priklop priključnega modula (KL06/KL08NSB/KL08RF) z večjim številom pogonov ali drugih naprav, priključenih na ta modul, da se razbremenijo njegovi kontakti (črpalke, pogoni, električne grelne podloge). Napajanje 230V AC 50Hz, maksimalna obremenitev 16A/250V AC, povezava z breznapetostnim relejem NO/COM, napetostni vhod SL 230V AC, izhodni signal rele 230V AC, dim.: 47x47x20mm.

Koda	Naziv	EAN: 8592920000717	Cena
FS300	Talno senzor - temperaturno tipalo, dolžina 3m		10,61

Talno tipalo za namestitev v tleh za daljinsko merjenje temperature zraka v prostoru. Kompatibilno za serije: EXPERT HTR (HTRP230, BTRP230); EXPERT NSB (VS30W, VS30B, VS35W, VS35B); SmartHome (SQ610, SQ610RF, VS10WRF, VS10BRF, VS20WRF, VS20BRF, HTRS-RF(30), HTRP-RF(50), TS600); Termostat za ventilatorski konvektor FC600. Merilno območje -10-100°C, merilni element NTC 10kΩ, dolžina kabla 3m, prerez žice 2 x 0,5mm.

TERMOSTATI - serija RT

Koda	Naziv	EAN: 5060103693580	Cena
RT510	Žični elektronski termostat, tedenski		58,32

Za žično krmiljenje ogrevalnih naprav (neposredno povezan s kotlom). Funkcije: časovni načrt, začasna sprememba temperature, način zaščita pred zmrzovanjem (razpon temperature 5-17°C), počitnice in mirovanje. Samodejno povezovanje. Nadometna montaža. Napajanje 2 x AA baterije. Maksimalna obremenitev 3(1)A, izhodni signal rele NO/COM/NC. Temperaturno območje 5-35°C. Temperaturna natančnost 0,1 ali 0,5°C. Histereza ±0,25°C. Komunikacija žična. Dimenzije: 120x96x27mm.

Koda	Naziv	EAN: 5060103693603	Cena
RT510RF	Brezžični elektronski sobni termostat, tedenski		109,43

Za brezžično krmiljenje ogrevalnih naprav, opremljenih z vhodom za termostat ON/OFF. Priporočljiv za plinski ali oljni kotel. Krmilni algoritem TPI, samodejno ponavlja signal, deluje po časovnem načrtu, način zaščita pred zmrzovanjem (razpon temperature 5-17°C), način počitnice in mirovanje. Napajanje oddajnika 2 x AA baterije, sprejemnika 230V AC 50Hz. Maksimalna obremenitev 16(5)A. Izhodni signal rele NO/COM/NC. Temperaturno območje 5-35°C. Temperaturna natančnost 0,1 ali 0,5°C. Histereza ±0,25°C. Komunikacija brezžična (868MHz). Dimenzije: oddajnik (RT510TX) 120x96x27mm, sprejemnik (RXRT510) 96x96x27, s stojalom. Že tovarniško povezan za delovanje.

Koda	Naziv	EAN: 5060103694204	Cena
RT510SPE	Brezžični elektronski sobni termostat, tedenski, sprejem. vtičak		133,10

Za brezžično krmiljenje ogrevalnih naprav, ki imajo kabel z vtičem (el.grelniki, obtočne črpalke). Priporočljiv za črpalko. Krmilni algoritem TPI, samodejno ponavlja signal, deluje po časovnem načrtu, način zaščita pred zmrzovanjem (razpon temperature 5-17°C), način počitnice in mirovanje. Napajanje oddajnika 2 x AA baterije, sprejemnika 230V AC 50Hz. Maksimalna obremenitev 16(5)A. Izhodni signal rele NO/COM/NC. Temperaturno območje 5-35°C. Temperaturna natančnost 0,1 ali 0,5°C. Histereza ±0,25°C. Komunikacija brezžična (868MHz). Dimenzije: oddajnik (RT510TX) 120x96x27mm, sprejemnik (SPE868) 42x77x42. Že tovarniško povezan za delovanje.

Koda	Naziv	EAN: 5060103695713	Cena
RT510SR	Brezžični elektronski sobni termostat, tedenski, sprejem. rele		116,88

Za brezžično krmiljenje električnih ogrevalnih naprav. Priporočljiv za grelne plošče, električne grelnike. Krmilni algoritem TPI, samodejno ponavlja signal, deluje po časovnem načrtu, način zaščita pred zmrzovanjem (razpon temperature 5-17°C), način počitnice in mirovanje. Napajanje oddajnika 2 x AA baterije, sprejemnika 230V AC 50Hz. Maksimalna obremenitev 16(5)A. Izhodni signal rele NO/COM. Temperaturno območje 5-35°C. Temperaturna natančnost 0,1 ali 0,5°C. Histereza ±0,25°C. Komunikacija brezžična (868MHz). Dimenzije: oddajnik (RT510TX) 120 x 96 x 27mm, sprejemnik rele (SR868) 44x44x26. Že tovarniško povezan za delovanje.



INTERNETNI TERMOSTATI - serija RT

Koda	Naziv	EAN: 5060103693733	Cena
RT310i	Internetni brezžični sobni termostat		193,74

Za krmiljenje električnih ogrevalnih naprav preko interneta preko aplikacije RT310i. Port 1x10/100 LAN. Za naprave z vhodom ON/OFF. Krmilni algoritem TPI, samodejno ponavlja signal, način zaščita pred zmrzovanjem (razpon temperature 5-9°C). Napajanje oddajnik 2 x AA baterije, sprejemnik 230V AC 50Hz, prehod 5VDC. Maksimalna obremenitev 16(5)A. Temperaturno območje 5-35°C. Histereza ±0,25°C. Temperatura natančnost 0,1 ali 0,5°C. Komunikacija brezžična (868MHz). Dimenzije: oddajnik (RT310TX) 96x96x27mm, sprejemnik (SR868) 96x96x27. Internetni prehod (ITG310) 39x91x25mm, podstavek. Že tovarniško povezan za delovanje.

Koda	Naziv	EAN: 5060103694211	Cena
RT310iSPE	Internetni brezžični sobni termostat, sprejemnik vtič		217,40

Za krmiljenje električnih ogrevalnih naprav preko interneta preko aplikacije RT310i, Port 1x10/100 LAN. Za naprave, ki imajo kabel z vtičem (električni grelniki, obtočne črpalke). Krmilni algoritem TPI, samodejno ponavlja signal, način zaščita pred zmrzovanjem (razpon temperature 5-9°C). Napajanje oddajnik 2 x AA baterije, sprejemnik 230V AC 50Hz, prehod 5VDC. Maksimalna obremenitev 16(5)A. Temperaturno območje 5-35°C. Temperatura natančnost 0,1 ali 0,5°C. Komunikacija brezžična (868MHz). Histereza ±0,25°C. Dimenzije: oddajnik (RT310TX) 96x96x27mm, sprejemnik vtič Schuko (SPE868) 96x96x27, internetni prehod (ITG310) 39x91x25mm, podstavek. Že tovarniško povezan za delovanje.

Koda	Po naročilu Naziv	EAN: 5060103693733	Cena
RT310iSR *	Internetni brezžični sobni termostat, sprejemnik rele		197,64

Za krmiljenje električnih ogrevalnih naprav preko interneta preko aplikacije RT310i. Port 1x10/100 LAN. Priporočljiv za grelne plošče, električne grelnike. Krmilni algoritem TPI, samodejno ponavlja signal, način zaščita pred zmrzovanjem (razpon temperature 5-9°C). Napajanje oddajnik 2 x AA baterije, sprejemnik 230V AC 50Hz, prehod 5VDC. Maksimalna obremenitev 16(5)A. Temperaturno območje 5-35°C. Temperatura natančnost 0,1 ali 0,5°C. Histereza ±0,25°C. Komunikacija brezžična (868MHz). Dimenzije: oddajnik (RT310TX) 96x96x27mm, sprejemnik rele (SR868) 44x44x26, internetni prehod (ITG310) 39x91x25mm, podstavek. Že tovarniško povezan za delovanje.

INTERNETNI TERMOSTATI - serija iT

Koda	Naziv	EAN: 5060103691852	Cena
iT500	Internetni sobni termostat za 2 coni		301,83

Za krmiljenje CO in časovno krmiljenje TSV ene ali dveh neodvisnih con ogrevanja, ali ena cona + topla voda z dodatnim modulom iT300; preko aplikacije iT500Plus za telefon ali PC. ECO in HOLIDAY način. Obseg temperature 5-35°C, zaščita proti zmrzali. Napajanje: termostat iT500TR - 2xAA bateriji, sprejemnik iT500RX - 230V AC 50Hz, prehod iTG500 z napajalnikom 230V AC 50Hz. Maks. obremenitev CH1:16A uporovno, 5A induktivno, CH2: 5A uporovno, 3A induktivno. Izhod 2 x rele NO/COM/NC. V paketu: termostat iT500TR dim.128x95x30mm; brezžični sprejemnik iT500RX (se priključi na kotel); dim. 150x100x35mm, internetni prehod iTG500, dim. 39x91x25mm; antena: 70mm.

Koda	Naziv	EAN: 5060103691869	Cena
iT300	Brezžično temperaturno tipalo druge cone za iT500		51,48

Za delovanje z internetnim termostatom iT500 ali brezžičnim termostatom XT500 za krmiljenje druge ogrevalne cone. Napajanje baterije 2 x AAA, brezžična komunikacija, dimenzije 76x76x22mm.

TERMOSTATI - serija STANDARD

Koda	Naziv	EAN: 5060103690053	Cena
RT200	Žični elektronski termostat, dnevni		29,28

Nadometni žični termostat za krmiljenje naprav z napetostjo 230V. Delovanje prikazano s signalizacijskim LED-obročem. Napajanje 230V AC 50Hz, najvišja obremenitev 3(1)A SPST, izhod 230V AC 50Hz, temperaturno območje 5-35°C, dimenzije 95x95x40mm.

Koda	Naziv	EAN:5060103690947	Cena
091FLV2	Žični elektronski sobni termostat - tedenski		55,39

Za žično krmiljenje ogrevalnih naprav (plinski, oljni kotli, toplotne črpalke) in hladilnih naprav. Priključi se neposredno na napravo. 9 programov, 3 temperaturne ravni, način ogrevanje/hlajenje. Napajanje 2xAA bateriji, maksimalna obremenitev 5(3)A, breznapetostni rele NO/COM, temperaturno območje 5-30°C, temperaturna natančnost 0,2°C; žična komunikacija; dimenzije termostata: 154x80x30mm.

Koda	Naziv	EAN: 5060103696314	Cena
091FLRFV2	Brezžični digitalni sobni termostat, programski		106,99

Za žično krmiljenje ogrevalnih naprav (plinski, oljni kotli, toplotne črpalke) in hladilnih naprav. Sodeluje z vtiči SPE868 in relejem SR868. Priključi se neposredno na napravo. 9 programov, 3 temperaturne ravni, način ogrevanje/hlajenje. Napajanje oddajnik 2xAA bateriji, sprejemnik 230V AC 50Hz; maksimalna obremenitev 16(5)A, breznapetostni rele NO/COM, temperaturno območje 5-30°C, temperaturna natančnost 0,2°C; brezžična komunikacija 868MHz; dimenzije: oddajnik 154x80x30mm, sprejemnik RXRT510 96x96x27mm.

Koda	Naziv	EAN: 5060575650005	Cena
RR868	Brezžični krmilni set - stikalo		84,91

Komplet je namenjen brezžičnemu posredovanju signala o delovanju ali okvari električnih naprav, npr. črpalke, ventilatorjev, osvetlitve. Idealna rešitev povsod, kjer ni mogoča žična napeljava. Oddajnik in sprejemnik se lahko namestita v dozi φ 60 mm in sta že tovarniško povezana. Napajanje 230V AC 50Hz, maksimalna obremenitev 5(3)A, izhodni signal sprejemnika 230V AC, brezžična komunikacija 868MHz; dimenzije oddajnik 45x45x20mm, sprejemnik 84x84x20mm.

TERMOSTATI - serija STANDARD

Koda	Naziv	EAN: 8592920000755	Cena
------	-------	--------------------	------

PC12HW	Termostat za 2 črpalki (CO in TSV)		98,82
---------------	------------------------------------	--	--------------

Termostat - krmilnik se vključi, ko temperatura kotla preseže prednastavljeno temperaturo za vklop črpalke in deluje do izravnave temperature kotla in zalogovnika ali do nastavljene temp. zalogovnika. Izpiše izmerjeno temperaturo, možnost ročni način, deluje v poletnem načinu (omeji črpalko), funkcija anti-stop, optimizira temperaturo vode, zvočni alarm ob previsoki temperaturi, enostavna uporaba-3 tipke. Napajanje: 230V AC 50Hz. Poraba energije: 2W. Temp.okolja -10 do 50°C. Temp.razpon: 0-99 °C. Nastavljivo temp.območje 5-80°C za C in TSV. Najvišja obremenitev 6 A. Dolžina kabla 1,2m. Dimenzije 155x70x35mm.

Koda	Naziv	EAN: 5060103691524	Cena
------	-------	--------------------	------

AT10	Cevni termostat mehanski naležni 230V		20,50
-------------	---------------------------------------	--	--------------

Mehanski naležni termostat za vklop obtočnih črpalk, kotla, aktiviranje ventilov ali kot zaščitni termostat pri talnem ogrevanju za izklop obtočne črpalke v primeru zaznave previsoke temperature vode. Gumb za enostavno spreminjanje temperature. Temperaturno območje 30 - 90°C. Napajanje 230V AC 50Hz, maksimalna obremenitev 16(4)A, izhodni signal kontakti NO/COM/NC, dimenzije 105x45x50mm.

Koda	Naziv	EAN: 5060103691531	Cena
------	-------	--------------------	------

AT10F	Cevni termostat naležni s kapilaro 230V		21,84
--------------	---	--	--------------

Mehanski naležni termostat z zunanjim temperaturnim tipalom (kapilara) za vklop obtočnih črpalk, kotla, aktiviranje conskih ventilov oz. preklopnih ventilov med polnjenjem zalogovnikov TSV, ali kot zaščitni termostat. Gumb za enostavno spreminjanje temperature. Temperaturno območje 30 - 90°C, napajanje 230V AC 50Hz, maksimalna obremenitev 16(4)A, izhodni signal kontakti NO/COM/NC, dimenzije 105x45x50mm, dolžina kapilare 1200mm, ø kapilare 7mm.

VREMENSKI REGULATOR

Koda	ODPRODAJA Naziv	EAN: 5060103695287 / 5060103698059	Cena
------	-----------------	------------------------------------	------

MULTIMIX3000	Vremenski regulator Multi Mix		587,77
---------------------	-------------------------------	--	---------------

CT10-X 3M	Tipalo, dolžina 3m		21,23
------------------	--------------------	--	--------------

Regulator ogrevanja za posamezne ali skupino ogrevalnih virov (plin, olje, peleti, toplotne črpalke, kamini, lesnopljinjevalni kotli). Regulira do dva vira ogrevanja, dva ogrevalna kroga, sanitarno vodo, zalogovnik, sončne kolektorje, oz.: 6 izhodov za obtočno črpalko, 2 mešalna ventila 230V, 4 napetostni izhodi 230V. Breznepetostni izhod (NO/COM/NC): nadzor glavnega vira ogrevanja. Stopnja zaščite: IP20. Temp. okolice: 50°C. Dimenzije: 340x225x60mm. Tipalo za merjenje temp.tekočine se namesti na cev ali v posodo, merilno območje 0-100°C, merilno območje NTC 10kΩ, dolžina kabla 3m, prerez žice 2 x 0,5mm.

Koda	Po naročilu Naziv	EAN: 5060103694037	Cena
------	-------------------	--------------------	------

WT100	* Vremensko voden termostat s tipali		260,59
--------------	--------------------------------------	--	---------------

Regulira temperaturo v ogrevalni zanki s 3-potnim ali 4-potnim ventilom, opremljen s tritočkovnim pogonom. Samodejno prepozna začetek ogrevalne sezone. Nadzira delovanje črpalke. Funkcije: urnik, zaščita proti zmrzali, zaščita črpalke v času daljšega mirovanja. Možnost dodatne obtočne črpalke in krmiljenje preko breznapetostnega kontakta. Sodeluje z vsemi termostati tipa ON/OFF. Napajanje: 230V AC / 50Hz. Maks. obremenitev: 3A. Vhodi: T1-temp. napajanja; T2-zunanja temp.; T3-povratna temp.; T4-temp.kotla (sklopke); TP-vhod za sobni termostat (ON/OFF). Izhodi: Toplotna črpalka 230V/1,5A, pogon z mešalnim ventilom 230V/0,5A; vir toplote rele NO/COM. Temp. okolja: T40. Stopnja zaščite: IP20. Dimenzije: 140 x 95 x 40mm. V kompletu: tipalo zunanje temp. CT6-P, naležno tipalo CT10-X (2kosa).

TERMOELEKTRIČNI POGONI 230V

Koda	Naziv	EAN: 5060103691920	Cena
------	-------	--------------------	------

T30NC230V	Termoelektrični pogon - zaprt NC 230V		22,45
------------------	---------------------------------------	--	--------------

Za uporabo s termostatičnimi ventili v delilniku za talno ogrevanje ali z obhodnimi ventili. Omogoča prekinitve dovoda ogrevalnega medija v del sistema. S sobnimi termostati deluje neposredno ali prek priključnih modulov (žičnih ali brezžičnih). Ko ni napetosti, pogon sklone tokokrog. Funkcija FirstOpen za lažjo namestitve. Napajanje 230V AC50Hz, I_{max} 200mA/200ms, poraba 2W, moč pritiska 100N, čas odpiranja 2min, premik pogona 4mm, navoj M30 x 1,5/M28 x 1,5. Dimenzije 40x70x40, dolžina napajalnega kabla 89cm.

Koda	Naziv	EAN: 5060103693689	Cena
------	-------	--------------------	------

THB230V30	Samoregulacijski pogon NC 230V		72,47
------------------	--------------------------------	--	--------------

Za talno ogrevanje, z dvema tipaloma na začetku in na koncu zanke samodejno uravnava razliko temperature ($\Delta T=7^{\circ}C$) in prilagaja pretok vode. Napajanje 230V AC50Hz, poraba 0,5W, čas odpiranja 30sek, stopnja zaščite IP54, navoj M30x1,5; dimenzije 93x38x54, dolžina napajalnega kabla 93cm, dolžina kabla za senzorje 45cm.

PREHODNI / PREKLOPNI MOTORNI VENTILI

Koda	Naziv	EAN: 5060103694846 / 5060103694839	Navoj	Cena
------	-------	------------------------------------	-------	------

PMV21	Dvopotni elektromotorni prehodni krogelni ventil		DN25 (1")	128,71
--------------	--	--	-----------	---------------

PMV24	Dvopotni elektromotorni prehodni krogelni ventil		DN20 (3/4")	128,71
--------------	--	--	-------------	---------------

Conski ventil za krmiljenje pretoka vode v centralni ogrevalni napravi. Standardni hidravlični in električni priključki. Poraba: 6W. Napajanje: 230V AC / 50Hz. Poraba: 6W. Maks. obremenitev: 3A. Izhod: kontakti NO/COM. Maks.statični tlak: 8,6 bar. Dif. tlak: 1" - 0,8bar, 3/4" - 0,6bar. Odziv: odpiranje 14sek., zapiranje 3sek. Temp.razpon tekočine 5 - 88°C. Pretočni koeficient: 8,6. Stopnja zaščite: IP20. Dimenzije: 87x55x60mm.

Koda	Naziv	EAN: 5060103694860 / 5060103694853	Navoj	Cena
------	-------	------------------------------------	-------	------

PMV31	Tripotni elektromotorni preklopni ventil		DN25 (1")	153,11
--------------	--	--	-----------	---------------

PMV34	Tripotni elektromotorni preklopni ventil		DN20 (3/4")	153,11
--------------	--	--	-------------	---------------

Tripotni preklopni ventil za krmiljenje pretoka vode v centralni ogrevalni napravi. Standardni hidravlični in električni priključki. Napajanje: 230V AC / 50Hz. Poraba: 6W. Maks.obremenitev: 3A. Izhod: kontakti NO/COM. Maks.statični tlak: 8,6 bar. Diferenčni tlak: 1" - 0,8bar, 3/4" - 0,6bar. Odziv: odpiranje 14sek., zapiranje 3sek. Temp.razpon tekočine 5 - 88°C. Pretočni koeficient: 8,6. Stopnja zaščite: IP20. Dim.: 87x55x60mm.

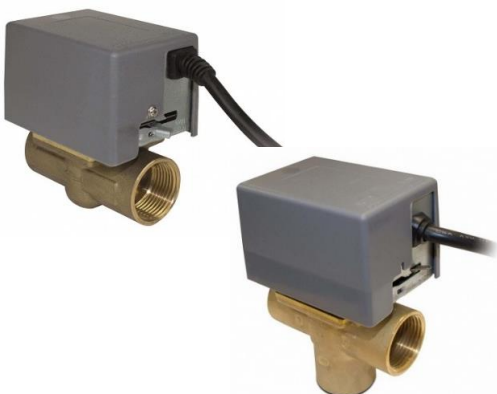

TERMOSTATI



Koda	*Po naročilu Naziv	Cena
E10W230WiFi	Programski digitalni termostat, žični WiFi, bel	103,70
E10B230WiFi*	Programski digitalni termostat, žični WiFi, črn	103,70

E10W je termostat za oddaljen nadzor nad ogrevalnim sistemom preko aplikacije ENGO Smart/Tuya Smart. Možnost deljenja naprav več uporabnikom, v aplikaciji na voljo grafi z zgodovino temperatur, možnost določanja minimalne in maksimalne temperature, združljivo z Google Home, Amazon Alexa, prilagodljiva moč osvetlitve zaslona, možnost priklopa dodatnega senzorja NTC, push-sporočila iz aplikacije. Napajanje 230V AC 50Hz. Največja obremenitev 3 (1) A. Razpon nastavljanja temp. 5 – 45°C. Točnost prikaza temp.0.1°C. Krmilni algoritem TPI ali Histereza (±0.1°C – ±0.5°C). Komunikacija WiFi 2.4 GHz. Vhod S1 – S2: temperatura tal ali merjenje temperature zraka. Izhodni signal: breznapetostni rele NO/COM. Razred zaščite IP30. Dimenzije [mm] 86 x 86 x 39 (14 po namestitvi v dozi s premerom 60).



Koda	Naziv	Cena
E901	Programski elektronski termostat, žični, stenski	79,30

E901 je tedenski nadometni elektronski sobni termostat, namenjen žičnemu upravljanju naprav in ogrevalnih ali hladilnih sistemov. Vzdržuje udobne razmere v prostoru, skladno z urnikom ali programirano zeleno konstantno temperaturo. Priključni se neposredno na napravo. 2 tipa časovnih načrtov, omejitev maksimalne/minimalne temperature, funkcija OGREVANJE/HLAJENJE, možnost izbire med histerezo in vgrajenim algoritmom TPI, programska sprememba vrste releja - normalno odprt (NO) ali navadno zaprt (NC), blokada PIN. Napajanje 2 x AA alkalne baterije. Največja obremenitev 5 (3) A. Izhodni signal breznapetostni rele NO/COM. Razpon nastavljanja temperature 5 – 35°C. Natančnost prikaza temp.0.1°C ali 0.5°C. Krmilni algoritem TPI ali Histereza (±0.1°C – ±0.5°C). Komunikacija žična. Dimenzije [mm] 150 x 84 x 22.

Koda	Naziv	Cena
E901RF	Programski elektronski termostat, brezžični / prenosni	134,20

E901RF je nadometni tedenski sobni termostat, namenjen brezžičnemu upravljanju naprav in ogrevalnih ali hladilnih sistemov. Tovarniško povezan s sprejemnikom npr. na kotel. V kompletu: oddajnik za termostat (E901TX), sprejemnik za termostat (E901RX). 2 tipa časovnih načrtov, omejitev maks./min. temperature, funkcija OGREVANJE/HLAJENJE, neponovljive komunikacijske kode, omejitev maks./min. temperature, programska sprememba vrste releja - normalno odprt (NO) ali navadno zaprt (NC), blokada PIN, samodejno ponavljanje signala. Delovno območje do 100 m v odprtem prostoru. Napajanje oddajnika 2 x AA alkalne baterije. Napajanje sprejemnika: 230V AC 50Hz. Največja obremenitev 16 (5) A. Izhodni signal: breznapetostni rele NO/COM. Razpon nastavljanja temperature 5 – 35°C. Natančnost prikaza temp.0.1°C ali 0.5°C. Krmilni algoritem TPI ali Histereza (±0.1°C – ±0.5°C). Komunikacija brezžična, 868 MHz. Dimenzije oddajnika [mm] 150 x 84 x 22. Dimenzije sprejemnika [mm] 96 x 96 x 27.

Koda	Naziv	Cena
E901WiFi	Programski elektronski termostat, WiFi	169,58

Internetni brezžični regulator temperature E901WiFi omogoča ekonomično in ekološko krmiljenje katere koli vrste ogrevanja. Odlikujeta ga pregleden meni in vrsta uporabnih funkcij. Upravljanje z regulatorjem je zelo enostavno in omogoča prilagoditev ogrevanja dnevnemu ritmu uporabnikov. Vgrajen modul WiFi (v sprejemniku) omogoča daljinsko upravljanje grelnega sistema z uporabo aplikacije ENGO Smart / TUYA Smart v pametnem telefonu ali tablici. Omogoča pregled nad stanjem stikala sprejemnika, ki se ga poveže npr. s kotlom. Naprave so tovarniško pripravljene za uporabo. V sestavu: oddajnik regulatorja (E901TXWIFI), sprejemnik regulatorja (E901RXWIFI), podstavek regulatorja. Možnosti: izbira med histerezo ali vgrajenim algoritmom TPI, programska sprememba tipa releja, blokada PIN, številne funkcije, ki so na voljo v aplikaciji ENGO Smart / Tuya Smart, omejitev najvišje / najnižje temperature, funkcija GRETJE/HLAJENJE, neponovljive kode za prenos, samodejno ponavljanje signal delovanja. Napajanje oddajnika 2 x AA alkalne baterije. Napajanje regulatorja: 2x AA alkalne baterije. Napajanje sprejemnika: 230V AC 50Hz. Največja obremenitev 16 (5) A. Izhodni signal: breznapetostni rele NO/COM. Razpon nastavljanja temperature 5 – 35°C. Natančnost prikaza temp. 0.5°C. Krmilni algoritem TPI ali Histereza (±0.25°C – ±0.5°C). Komunikacija brezžična, 868 MHz in WiFi. Dimenzije oddajnika [mm] 150 x 84 x 22. Dimenzije sprejemnika [mm] 96 x 96 x 27.



Koda	Naziv	Cena
ESIMPLE230W	Žični nadometni regulator temperature z gumbom, 230V bel	29,89
ESIMPLE230B	Žični nadometni regulator temperature z gumbom, 230V črn	29,89

ESIMPLE230B je namenjen za krmiljenje površinskega ogrevanja/hlajenja, za katerega je značilna visoka toplotna vztrajnost. Nastavitve temperature v prostoru se izvaja z zasučnim gumbom. S svojim vgrajenim algoritmom nudi veliko boljše natančnost uravnavanja temperature kot tradicionalni mehanski termostati. Enoštaven regulator z zasučnim gumbom, preklopno stikalo GRETJE/HLAJENJE skrito pod zasučnim gumbom, nadometna namestitve, algoritem TPI, ki je idealen za talno ogrevanje, dvobarvna dioda LED. Napajanje: 230V AC 50Hz. Največja obremenitev: 3 (1) A. Razpon nastavitve temp.: 5 – 30°C. Krmilni algoritem: TPI ali Histereza (±0.5°C). Komunikacija: Žična. Krmilni izhod: 230V AC. Razred zaščite: IP30. Dimenzije [mm]: 80 x 80 x 26mm.

TERMOSTATI

Koda	Naziv	Cena
EASY230W	Žični sobni bistabilni termostat EASY230W bel	41,48
EASY230B*	Žični sobni bistabilni termostat EASY230B črn	41,48



Žični dnevni termostat z omrežnim (230V) napajanjem za upravljanje naprav in ogrevalnih / hladilnih sistemov. Minimalističen dizajn, breznapetostni kontakt, žična komunikacija, zelo enostavna uporaba, LCD zaslon, programska sprememba vrste releja, funkcija zaklenitve tipk, možnost nastavitve min./maks. temperature. V kompletu element za obešanje na steno. Krmiljenje talnega ogrevanja ali krmiljenje vira ogrevanja. Natančen algoritem uravnavanja temperature TPI, preklopno stikalo OGREVANJE/PRIPRAVLJENOST/HLAJENJE. Napajanje: 230V. Največja obremenitev: 3 (1) A. Razpon nastavitve temp.: 5 – 35°C. Točnost: 0.1°C. Krmilni algoritem: TPI ali Histereza (±0.2°C do ±2°C). Komunikacija: Žična. Krmilni izhod: NO/COM (breznapetostni). Razred zaščite: IP30. Dimenzije [mm]: 80 x 80 x 22mm.

Koda	Naziv	Cena
EASYBATW*	Žični sobni bistabilni termostat EASYBATB bel, baterijsko napaja	42,70
EASYBATB*	Žični sobni bistabilni termostat EASYBATB črn, baterijsko napaja	42,70



Žični dnevni termostat z baterijskim napajanjem za upravljanje naprav in ogrevalnih / hladilnih sistemov. Minimalističen dizajn, breznapetostni kontakt, žična komunikacija, zelo enostavna uporaba, LCD zaslon, programska sprememba vrste releja, funkcija zaklenitve tipk, možnost nastavitve min./maks. temperature. V kompletu element za obešanje na steno. Krmiljenje talnega ogrevanja ali krmiljenje vira ogrevanja. Natančen algoritem uravnavanja temperature TPI, preklopno stikalo OGREVANJE/PRIPRAVLJENOST/HLAJENJE. Napajanje: bateriji 2 x AAA. Največja obremenitev: 3 (1) A. Razpon nastavitve temp.: 5 – 35°C. Točnost: 0.1°C. Krmilni algoritem: TPI ali Histereza (±0.2°C do ±2°C). Komunikacija: Žična. Krmilni izhod: NO/COM (breznapetostni). Razred zaščite: IP30. Dimenzije [mm]: 80 x 80 x 22mm.

Koda	Naziv	Cena
ECB08M230*	Žična centrala do 8 con upravljanja, 230V	103,70



Centralna letev je namenjena upravljanju površinskega ogrevanja (8 con). Omogoča udoben priklop žičnih termostatov in pogonov. Opremljena je z vgrajenim modulom za krmiljenje grelne naprave (breznapetostni kontakt). ECB08M230 upravlja temperaturo v prostorih z zapiranjem ali odpiranjem pretoka skozi ogrevalne zanke. To lahko stori s pomočjo termoelektričnih pogonov, ki se namestijo na razdelilniku. Napetostni izhod za upravljanje obtočne črpalke, 2 namenska izhoda za pogone za vsako izmed 8 con, primerna za montažo na releju DIN, sodeluje z bistabilnimi termostati ali termostati z izhodom 230V AC, vgrajena funkcija poznejšega vklopa črpalke in kotla - 3 min. Napajanje: 230V AC 50Hz. Največja obremenitev: 6(1)A. Izhodi: črpalka (230V), kotel (NO/COM/NC), termoelektrični pogon (230 V). Dimenzije [mm] 330 x 110 x 36.

Koda	Naziv	Cena
E30NC230	Pogon / aktuator, normalno zaprt NC, M30 x 1,5; 230V	20,74



Termoelektrični pogon je namenjen upravljanju ogrevalnega sistema. Pogon lahko uporabite npr. z ventilskim vložki v razdelilniku za talno ogrevanje ali z conskimi ventili. Omogoča odpiranje oz. zapiranje pretoka ogrevalnega medija skozi zanko in s tem nadzor nad temperaturo. Sodeluje s termostatom neposredno oz. posredno preko krmilne letve. Verzija: NC = navadno zaprt. Velikost navoja: M30 x 1.5mm. Napajanje: 230V AC 50Hz. Poraba moči 2W. Tok 300mA / 200ms. Moč pritiska 100N +/- 15%. Max. Skok 4.5 mm. Temperatura shranjevanja. od -25°C do +60°C. Temp. okolja: Max. 60°C. Stopnja zaščite IP 54/II. Dolžina kabla 90 cm. Dimenzije [mm] Φ 41 x 65.

SOBNI ANALOGNI TERMOSTAT ZA GRETJE



Koda	Cena
TH-1149MSA *odprodaja	19,89

Poraba energije: 5A. Temp. območje zaslona: -10°C~50°C. Diferenca prikaza temperature: 0.1°C. Temperaturno območje regulacije: Diferenca za nastavev temperature: 1°C. Diferenca za preklop (histereza): 1.3°C (pri 20°C). Izbira stopnje cikla: 3, 6, 9, ali 12 na uro. Proti zamrzovalna zaščita: 5°C. Senzor temperature: NTC 10K Ohm @ 25°C. Pritrdilni set.

SOBNI DIGITALNI TERMOSTAT ZA GRETJE



Koda	Cena
TH-1149SA *odprodaja	39,04

Napajanje: 2x AA bateriji. Poraba energije: 5A. Zamenjava baterije enkrat letno. Temp. območje zaslona: -10°C~50°C. Diferenca prikaza temperature: 0.1°C. Temperaturno območje regulacije: 5°C~35°C. Diferenca za nastavev temperature: 1°C. Diferenca za preklop (histereza): 0.4°C~1.0°C (privzeto 0.6°C). Izbira stopnje cikla: 3, 6, 9, ali 12 na uro. Proti zamrzovalna zaščita: 5°C. Senzor temperature: NTC 10K Ohm @ 25°C. Pritrdilni set.

SOBNI ANALOGNI TERMOSTAT ZA GRETJE IN HLAJENJE



Koda	Cena
TH-1149MSB *odprodaja	28,79

Poraba energije: 5A. Temp. območje zaslona: -10°C~50°C. Diferenca prikaza temperature: 0.1°C. Temperaturno območje regulacije: Diferenca za nastavev temperature: 1°C. Diferenca za preklop (histereza): 1.3°C (pri 20°C). Izbira stopnje cikla: 3, 6, 9, ali 12 na uro. Proti zamrzovalna zaščita: 5°C. Senzor temperature: NTC 10K Ohm @ 25°C. Pritrdilni set.

SOBNI DIGITALNI TERMOSTAT ZA GRETJE IN HLAJENJE



Koda	Cena
TH-1149SB *odprodaja	43,92

Napajanje: 2x AA bateriji. Poraba energije: 5A. Zamenjava baterije enkrat letno. Temp. območje zaslona: -10°C~50°C. Diferenca prikaza temperature: 0.1°C. Temperaturno območje regulacije: 5°C~35°C. Diferenca za nastavev temperature: 1°C. Diferenca za preklop (histereza): 0.4°C~1.0°C (privzeto 0.6°C). Izbira stopnje cikla: 3, 6, 9, ali 12 na uro. Proti zamrzovalna zaščita: 5°C. Senzor temperature: NTC 10K Ohm @ 25°C. Pritrdilni set.

SOLARNI REGULATOR - 2 tipali



Koda	EAN	Cena
TH-813		79,06

Regulator za ogrevanje s sončnimi kolektorji, 4 hidravlične sheme.

PODOMETNI NAPAVALNIK



Koda	EAN	Cena
AD05-KU68	8594012229891	29,04

Adapter 230V AC/our 5V DC 2,5A.

TIPALO ZA SOLARNI REGULATOR



Koda	EAN	Cena
103AT		9,76

Tipalo za solarni regulator Frontier, dolžina 2m.

SOBNI DIGITALNI TERMOSTAT S TEDENSKO NASTAVITVIJO



Koda	EAN	Cena
PT22	8594012224322	68,93

Sobni stenski digitalni termostat s tedensko nastavitvijo. Za vse vrste kotlov, 6 dnevni sprememb temperature.

SOBNI DIGITALNI TERMOSTAT Z GSM POVEZAVO



Koda	EAN	Cena
PT32GST	8594012224360	241,56

Brezžični sobni daljinski termostat z GSM/GPRS povezavo za centralno ogrevanje, 6 dnevni sprememb temperature, avtomatska sprememba letni-zimski čas, možnost priključitve zunanjega temperaturnega tipala. Napajanje: priložene baterije

BREŽIČNI SOBNI DIGITALNI TERMOSTAT



Koda	EAN	Cena
BPT22*	8594012224339	168,97

Brezžični sobni digitalni termostat s tedensko nastavitvijo, 6 dnevni sprememb temperature, doseg 35m. Napajanje: priložene baterije

*odprodaja

SOBNI STENSKI DIGITALNI TERMOSTAT



Koda	EAN	Cena
PT23	8594012220416	82,47

Sobni stenski digitalni termostat s tedensko nastavitvijo, 6 sprememb temperature, za vse vrste kotlov samodejni prekolop letni/zimski čas, opozorilo ob izpraznjenih baterijah (2x1,5V AA), temp. območje 5-39°C, varovanje proti zmrazili,

TERMOSTIKALNA VTIČNICA (z nočnim znižanjem)



Koda	EAN	Cena
TS01	8594012229853	25,90

Elektronska termostikalna vtičnica s funkcijo nočnega znižanja temperature, nastavev od 11-28°C, z enim pritiskom gumba znižanje za 3 stopinje, zaščita proti zmrazovanju. Napajanje 230V/50Hz.

*Po naročilu



PLOŠČATI KOLEKTOR EM1V/2.0S Al-Cu

Koda	Naziv	Cena
1022-ENSOL	Ploščati kolektor EM1V/2.0S Al-Cu	553,29

PRIKLJUČNI SET za kolektor

Koda	Naziv	Cena
3201*	Povezovalni set za 1 kolektor EM1V/2.0	36,72
3202	Povezovalni set za 2 kolektorja EM1V/2.0	83,16
3203	Povezovalni set za 3 kolektorje EM1V/2.0	127,86

PRITRDILNA KONSTRUKCIJA

Koda	Naziv	Cena
2001-EN*	Pritrdilna konstrukcija za 1 kolektor	120,00
EN2002	Pritrdilna konstrukcija za 2 kolektorja	203,37
EN2003	Pritrdilna konstrukcija za 3 kolektorje	295,97

ALVEOFLEX SOLAR SOLO - ENOJNA CEV

Koda	Naziv	Dolžina (m)	Cena / m
01161350/M	Flexibilna cev za sončne kolektorje enojna DN16	50 m	20,01
01201350/M	Flexibilna cev za sončne kolektorje enojna DN20	50 m	23,30

ALVEOFLEX SOLAR DUO - DVOJNA CEV S KABLLOM

Koda	Naziv	V kolutu (m)	Cena / m
02161350/M	Flexibilna cev za sončne kolektorje dvojna DN16	50	35,14
02201350/M	Flexibilna cev za sončne kolektorje dvojna DN20	50	40,75

Koda	Naziv	Dimenzija	Cena
342686	Spojka s tesnilom kpl	DN 16	23,91
342723	Spojka s tesnilom kpl	DN 20	26,60

V34	Nipel	3/4"	8,11
V1	Nipel	1"	13,08

PM16	Matica NN	DN 16 (3/4")	3,72
PM20	Matica NN	DN 20 (1")	5,19

DK16	Ojačevalnik spoja	DN 16	1,12
DK20	Ojačevalnik spoja	DN 20	1,49

T34	Tesnilo za nipel	DN 16	0,37
T01	Tesnilo za nipel	DN 20	0,39

TIP 10

TIP 11

Po naročilu **Režim ogrevanja 20°C:**
t1=75°C, t2=65°C

dolžina (mm)	višina (mm)							višina (mm)							
	200	300	400	500	600	700	900	200	300	400	500	600	700	900	
400				48,63	48,63	56,72	68,52		69,50	72,47	82,68	86,41	96,54	107,71	
W				206	242	278	350		220	283	343	401	456	558	
500		49,36	50,95	53,68	54,75	64,50	78,29		79,82	80,59	91,68	95,31	107,64	124,51	
W		165	212	257	302	347	438		275	354	429	501	570	697	
600			52,58	57,55	59,80	62,48	73,63	88,83		87,07	88,61	100,25	105,52	120,50	140,87
W			198	254	308	362	416	525		329	424	515	601	683	836
700				66,03	68,93	81,20	98,05		94,32	97,28	109,03	115,62	133,36	157,01	
W				360	423	486	613		384	496	601	701	797	976	
800				71,29	76,55	90,01	108,48		102,55	105,63	119,02	125,39	146,53	173,81	
W				411	483	555	700		439	566	686	802	911	1115	
900				77,51	83,96	98,72	119,02		109,91	116,17	126,38	135,49	159,18	189,95	
W				463	544	625	788		494	637	772	902	1025	1255	
1000				82,67	91,69	107,64	129,23		116,17	126,38	136,37	147,02	173,08	206,31	
W				514	604	694	875		549	708	858	1002	1139	1394	
1100				91,69	99,09	115,73	139,56		124,54	138,57	146,36	158,44	185,73	223,00	
W				565	664	763	963		604	779	944	1102	1253	1533	
1200				99,09	106,93	125,89	149,99		136,04	150,76	155,15	169,86	200,04	240,79	
W				617	725	833	1050		659	850	1030	1202	1367	1673	
1400				113,05	124,54	143,73	171,07		153,61	175,46	173,81	192,70	228,14	274,72	
W				720	846	972	1225		769	991	1201	1403	1595	1952	
1600				128,19	139,57	161,56	191,60		171,29	200,28	192,48	216,75	255,83	307,55	
W				822	966	1110	1400		878	1133	1373	1603	1822	2230	
1800				143,54	157,18	180,85			190,28	225,20	212,35	240,79	284,24		
W				925	1087	1249			988	1274	1544	1804	2050		
2000				158,57	172,31	198,79			208,73	249,80	231,02	263,19	310,79		
W				1028	1208	1388			1098	1416	1716	2004	2278		
2300											259,79	298,66	351,65		
W											1973	2305	2620		
2600											287,24	334,12	394,16		
W											2231	2605	2961		
3000											325,67	380,79	448,71		
W											2574	3006	3417		

TIP 20

TIP 21

Po naročilu **Režim ogrevanja 20°C:**
t1=75°C, t2=65°C

dolžina (mm)	višina (mm)							višina (mm)						
	200	300	400	500	600	700	900	200	300	400	500	600	700	900
400				79,45	95,12	110,47			90,93	93,83	93,99	110,02	124,85	145,27
W				335	391	447			298	375	447	515	580	702
500				92,22	107,90	126,36			96,09	105,21	107,82	125,39	142,17	168,32
W				419	489	559			373	469	559	644	725	877
600				103,92	122,18	142,47			101,46	111,65	122,10	140,87	161,56	191,49
W				503	587	670			447	562	670	773	870	1052
700				115,41	135,06	158,14			106,82	118,20	136,59	156,25	179,40	214,33
W				587	685	782			522	656	782	902	1015	1228
800				128,51	147,94	174,14			111,65	124,64	150,43	171,29	197,13	237,61
W				670	782	894			596	750	894	1030	1160	1403
900				141,39	160,83	189,60			122,18	136,03	164,48	186,88	215,18	259,24
W				754	880	1005			671	843	1005	1159	1305	1579
1000				152,99	173,60	205,81			132,37	146,65	178,86	202,14	233,22	281,20
W				838	978	1117			745	937	1117	1288	1450	1754
1100				165,98	188,20	221,27			145,37	162,22	193,91	218,50	252,41	303,93
W				922	1076	1229			820	1031	1229	1417	1595	1929
1200				178,97	202,27	238,98			162,22	180,36	208,18	235,30	271,59	327,20
W				1006	1174	1340			894	1124	1340	1546	1740	2105
1400				203,55	230,72	271,84			182,94	203,55	239,03	268,57	309,54	372,11
W				1173	1369	1564			1043	1312	1564	1803	2030	2456
1600				230,72	259,06	305,01			204,52	226,85	268,46	301,51	348,33	416,91
W				1341	1565	1787			1192	1499	1787	2061	2320	2806
1800				255,19	287,62	338,08			226,85	251,33	297,67	333,57	385,25	462,92
W				1508	1760	2011			1341	1687	2011	2318	2610	3157
2000				281,18	315,96	370,93			249,93	277,10	328,52	367,83	424,96	509,25
W				1676	1956	2234			1490	1874	2234	2576	2900	3508
2300				306,83	343,23	411,94					370,90	415,04	479,61	
W				1927	2249	2569					2569	2962	3335	
2600				332,71	371,68	451,34					413,40	462,37	534,57	
W				2179	2543	2904					2904	3349	3770	
3000				358,80	398,84	500,73					470,82	524,62	608,62	
W				2514	2934	3351					3351	3864	4350	

TIP 22

TIP 33



Režim ogrevanja 20°C:
t1=75°C, t2=65°C

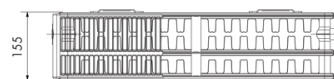

dolžina (mm)	višina (mm)							višina (mm)						
	200	300	400	500	600	700	900	200	300	400	500	600	700	900
400	105,30	113,20	107,38	124,95	142,02	157,67		145,06	150,27	177,11	193,58	226,85	251,22	
W	386	486	581	672	759	925		552	695	832	962	1089	1331	
500	116,72	126,38	123,74	141,09	165,37	189,41		161,89	169,38	201,37	215,32	255,62	290,09	
W	483	608	726	840	949	1157		690	869	1040	1203	1362	1664	
600	126,49	138,79	139,89	156,68	188,82	221,14		179,05	189,47	219,82	235,52	286,54	328,74	
W	580	730	871	1007	1138	1388		827	1043	1247	1444	1634	1997	
700	137,03	151,52	155,81	173,70	212,49	251,11		194,36	209,02	239,14	259,90	315,42	367,72	
W	676	851	1016	1175	1328	1619		965	1217	1455	1684	1906	2330	
800	136,05	148,45	163,71	172,28	189,41	236,27	282,30	193,89	209,99	228,89	258,69	279,88	344,52	406,48
W	519	773	973	1162	1343	1518	1850	747	1103	1390	1663	1925	2178	2662
900	146,53	156,68	178,10	188,64	206,20	258,34	316,99	209,78	226,82	248,32	278,23	303,60	374,90	446,78
W	584	869	1094	1307	1511	1707	2082	841	1241	1564	1871	2165	2451	2995
1000	156,59	169,75	190,28	204,78	217,49	283,29	349,05	225,24	242,78	267,76	297,67	324,79	402,60	484,33
W	649	966	1216	1452	1679	1897	2313	934	1379	1738	2079	2406	2723	3328
1100	168,20	181,72	205,00	221,91	242,00	306,43	375,41	239,95	260,05	287,09	321,27	351,58	435,77	521,66
W	714	1063	1338	1597	1847	2087	2544	1027	1517	1912	2287	2647	2995	3661
1200	178,26	193,58	219,49	239,14	263,96	330,20	401,54	255,62	276,77	306,30	344,99	377,82	466,16	557,67
W	779	1159	1459	1742	2015	2276	2776	1121	1655	2086	2495	2887	3268	3994
1400	198,79	216,75	246,83	273,84	305,90	378,71	450,40	286,54	310,65	345,94	391,99	429,43	528,21	631,68
W	909	1352	1702	2033	2351	2656	3238	1308	1931	2433	2911	3368	3812	4659
1600	220,36	239,69	275,82	307,88	347,52	425,41	502,66	317,03	344,20	384,26	437,88	482,02	591,98	721,94
W	1038	1546	1946	2323	2686	3035	3701	1494	2206	2781	3326	3850	4357	5325
1800	240,79	261,87	306,67	342,47	389,90	481,56	595,45	348,71	378,18	424,33	484,55	534,07	658,12	803,96
W	1168	1739	2189	2614	3022	3415	4163	1681	2482	3128	3742	4331	4901	5990
2000	262,57	284,93	335,00	377,16	431,73	532,72	657,04	378,98	411,95	462,23	531,76	585,01	721,24	881,91
W	1298	1932	2432	2904	3358	3794	4626	1868	2758	3476	4158	4812	5446	6656
2300	293,06	324,35	378,04	428,44	494,43	608,61		425,25	462,77	521,18	602,80	692,84	813,68	
W	1493	2222	2797	3340	3862	4363		2148	3172	3997	4782	5534	6263	
2600	325,00	358,50	422,40	480,38	557,67	684,18		471,42	513,04	578,51	662,20	760,04	901,29	
W	1687	2512	3162	3775	4365	4932		2428	3585	4519	5405	6256	7080	
3000	367,31	396,49	480,05	549,22	647,49	786,60		532,08	581,23	657,13	743,13	853,04	1018,95	
W	1947	2898	3648	4356	5037	5691		2802	4137	5214	6237	7218	8169	

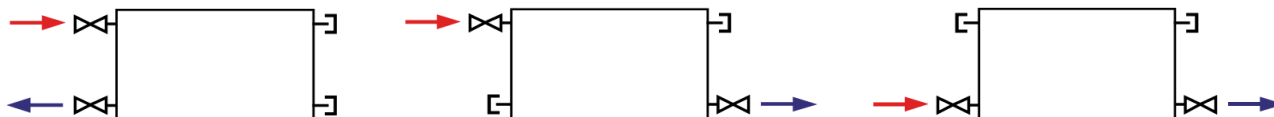
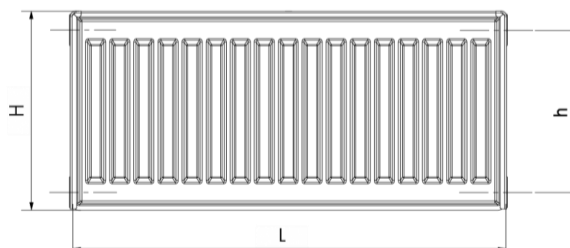

BARVNA LESTVICA: Standardna površinska barva radiatorjev je bela RAL 9016. Doplačilo 30% za drugo barvo s KORADO barvne lestvice (glej www.korado.si). Doplačilo 40% za drugo barvo z RAL lestvice.

SATIN GLOSS



HIGH GLOSS



MATTE



DEEP MATTE



TIP 10 TIP 11

Po naročilu **Režim ogrevanja 20°C:**
t1=75°C, t2=65°C

dolžina (mm)	višina (mm)						višina (mm)										
	200	300	400	500	600	700	900	200	300	400	500	600	700	900			
400				102,22	102,22	123,09	119,79				118,69	121,44	136,70	139,45	161,63	158,11	
W				206	242	278	350				220	283	343	401	456	558	
500		106,62	109,36	106,62	106,62	130,44	129,23				132,97	130,55	144,61	148,01	174,03	173,81	
W		165	212	257	302	347	438				275	354	429	501	570	697	
600			111,56	112,76	112,76	113,42	139,45	138,02				139,89	140,65	152,29	156,68	186,88	189,95
W			198	254	308	362	416	525				329	424	515	601	683	836
700				117,16	119,79	146,80	147,02				146,80	150,10	161,85	168,10	201,37	205,22	
W				360	423	486	613				384	496	601	701	797	976	
800				122,10	126,49	157,67	156,57				153,50	159,98	169,75	176,89	214,33	219,93	
W				411	483	555	700				439	566	686	802	911	1115	
900				127,92	132,97	165,03	168,32				160,53	168,10	184,46	185,78	227,18	235,41	
W				463	544	625	788				494	637	772	902	1025	1255	
1000				132,97	140,65	174,03	175,35				166,46	178,21	186,88	196,10	241,67	250,56	
W				514	604	694	875				549	708	858	1002	1139	1394	
1100				140,21	147,79	183,26	184,79				175,35	189,51	195,55	207,52	254,63	266,37	
W				565	664	763	963				604	779	944	1102	1253	1533	
1200				147,02	154,49	192,70	193,58				184,46	201,04	204,34	218,39	268,79	281,97	
W				617	725	833	1050				659	850	1030	1202	1367	1673	
1400				159,98	169,09	210,60	212,46				201,04	223,77	228,38	239,36	297,89	313,81	
W				720	846	972	1225				769	991	1201	1403	1595	1952	
1600				173,81	183,70	229,15	232,34				218,50	248,59	251,22	260,88	325,67	344,00	
W				822	966	1110	1400				878	1133	1373	1603	1822	2230	
1800				187,76	199,29	248,92					235,41	272,41	276,70	282,74	353,23		
W				925	1087	1249					988	1274	1544	1804	2050		
2000				201,04	214,22	267,25					252,98	294,04	299,86	305,02	382,43		
W				1028	1208	1388					1098	1416	1716	2004	2278		
2300													311,28	338,18	408,46		
W													1973	2305	2620		
2600													336,10	370,47	466,32		
W													2231	2605	2961		
3000													370,14	414,06	521,00		
W													2574	3006	3417		

TIP 20 TIP 21

Režim ogrevanja 20°C:
t1=75°C, t2=65°C

dolžina (mm)	višina (mm)						višina (mm)									
	200	300	400	500	600	700	900	200	300	400	500	600	700	900		
400				138,35	150,54	172,06					135,05	147,02	149,66	165,03	192,70	199,51
W				335	391	447					298	375	447	515	580	702
500				150,54	164,48	188,75					147,02	162,39	162,50	179,30	210,60	220,48
W				419	489	559					373	469	559	644	725	877
600				162,72	176,89	203,02					164,26	173,04	175,68	193,47	229,15	242,00
W				503	587	670					447	562	670	773	870	1052
700				173,37	190,83	219,82					169,53	185,01	189,41	207,85	247,05	263,96
W				587	685	782					522	656	782	902	1015	1228
800				185,56	202,91	234,31					185,78	189,51	202,25	223,00	265,28	284,49
W				670	782	894					596	750	894	1030	1160	1403
900				197,86	214,88	251,00					195,66	200,82	215,54	237,50	283,83	306,12
W				754	880	1005					671	843	1005	1159	1305	1579
1000				210,27	227,29	267,25					203,90	210,49	229,37	251,66	303,71	326,87
W				838	978	1117					745	937	1117	1288	1450	1754
1100				222,13	243,21	283,83					215,65	225,20	245,40	269,56	322,15	350,81
W				922	1076	1229					820	1031	1229	1417	1595	1929
1200				232,78	255,18	299,97					227,94	239,69	261,43	287,46	341,92	375,08
W				1006	1174	1340					894	1124	1340	1546	1740	2105
1400				258,80	283,17	333,02					255,61	276,15	286,36	313,48	380,35	430,53
W				1173	1369	1564					1043	1312	1564	1803	2030	2456
1600				283,17	311,28	365,74					294,81	319,08	313,48	345,43	418,67	474,99
W				1341	1565	1787					1192	1499	1787	2061	2320	2806
1800				307,55	337,31	396,49					333,79	359,16	343,23	376,50	457,32	519,35
W				1508	1760	2011					1341	1687	2011	2318	2610	3157
2000				332,15	365,19	429,65					367,94	401,54	370,90	409,22	497,17	565,25
W				1676	1956	2234					1490	1874	2234	2576	2900	3508
2300				356,63	393,08	469,94							415,26	454,57	549,88	
W				1927	2249	2569							2569	2962	3335	
2600				381,01	421,19	511,67							456,55	499,26	606,65	
W				2179	2543	2904							2904	3349	3770	
3000				405,27	448,97	561,19							513,10	561,30	683,29	
W				2514	2934	3351							3351	3864	4350	

TIP 22								TIP 33						
Po naročilu								Režim ogrevanja 20°C: t1=75°C, t2=65°C						
dolžina (mm)	višina (mm)							višina (mm)						
	200	300	400	500	600	700	900	200	300	400	500	600	700	900
400	148,89	171,84	163,27	176,23	205,22	212,57		206,20	211,80	234,53	253,31	287,46	302,94	
W	386	486	581	672	759	925		552	695	832	962	1089	1331	
500	157,67	183,59	178,86	193,36	229,15	243,65		222,56	231,46	257,26	274,83	316,44	340,16	
W	483	608	726	840	949	1157		690	869	1040	1203	1362	1664	
600	177,44	193,91	193,91	208,18	251,00	274,06		238,60	251,44	276,15	296,13	345,76	376,72	
W	580	730	871	1007	1138	1388		827	1043	1247	1444	1634	1997	
700	188,75	208,07	209,50	223,66	274,61	302,39		254,85	269,45	295,14	317,10	375,08	414,39	
W	676	851	1016	1175	1328	1619		965	1217	1455	1684	1906	2330	
800	196,76	202,25	221,58	225,20	239,80	299,97	333,02	259,24	261,21	278,01	313,48	348,94	404,28	451,06
W	519	773	973	1162	1343	1518	1850	747	1103	1390	1663	1925	2178	2662
900	208,07	214,33	232,01	242,33	255,39	322,15	363,33	275,93	276,15	296,68	333,46	358,50	433,38	488,06
W	584	869	1094	1307	1511	1707	2082	841	1241	1564	1871	2165	2451	2995
1000	220,70	221,69	245,51	256,05	270,77	345,76	393,63	290,64	291,41	313,48	352,13	380,46	462,48	525,50
W	649	966	1216	1452	1679	1897	2313	934	1379	1738	2079	2406	2723	3328
1100	232,01	233,98	259,24	272,85	290,64	369,37	418,12	307,11	307,66	333,02	375,19	405,60	493,55	560,86
W	714	1063	1338	1597	1847	2087	2544	1027	1517	1912	2287	2647	2995	3661
1200	244,74	246,61	272,85	290,09	310,62	393,08	442,82	321,93	324,35	352,13	398,03	430,42	522,65	595,45
W	779	1159	1459	1742	2015	2276	2776	1121	1655	2086	2495	2887	3268	3994
1400	268,68	271,54	300,52	324,46	350,15	440,74	493,55	353,23	369,92	388,47	455,34	505,19	585,01	664,84
W	909	1352	1702	2033	2351	2656	3238	1308	1931	2433	2911	3368	3812	4659
1600	292,29	293,61	329,40	356,85	391,00	490,26	544,17	385,95	402,42	424,27	501,79	559,10	650,57	781,01
W	1038	1546	1946	2323	2686	3035	3701	1494	2206	2781	3326	3850	4357	5325
1800	316,33	315,35	358,61	389,68	431,07	544,72	663,85	417,35	436,46	462,70	549,22	611,92	714,14	857,10
W	1168	1739	2189	2614	3022	3415	4163	1681	2482	3128	3742	4331	4901	5990
2000	340,16	336,65	386,17	423,83	470,49	595,45	724,46	448,31	469,40	509,47	596,10	665,28	776,73	933,52
W	1298	1932	2432	2904	3358	3794	4626	1868	2758	3476	4158	4812	5446	6656
2300	376,83	368,93	429,10	473,46	530,44	670,44		496,41	519,35	555,92	651,44	726,00	858,64	
W	1493	2222	2797	3340	3862	4363		2148	3172	3997	4782	5534	6263	
2600	411,75	402,20	471,92	523,09	590,07	747,08		542,19	569,97	608,84	717,10	798,80	948,12	
W	1687	2512	3162	3775	4365	4932		2428	3585	4519	5405	6256	7080	
3000	459,62	445,90	526,27	590,07	670,99	847,55		606,43	635,96	683,29	804,39	897,18	1068,57	
W	1947	2898	3648	4356	5037	5691		2802	4137	5214	6237	7218	8169	

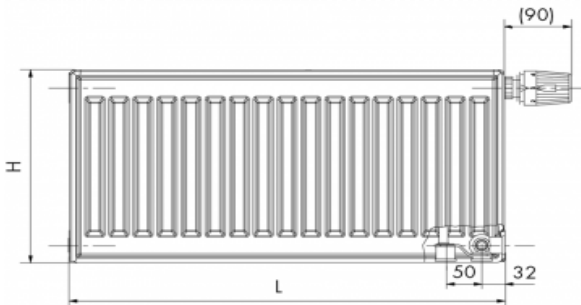

VK radiatorji imajo zadaj obešala za klasične stenske konzole (tip H).

VKU radiatorji so brez obešal, obe strani sta enaki, konzole za te radiatorje so prilagojene (tip C).

BARVNA LESTVICA: Standardna površinska barva radiatorjev je bela RAL 9016. Doplačilo 30% za drugo barvo s KORADO barvne lestvice (glej www.korado.si). Doplačilo 40% za drugo barvo z RAL lestvice.

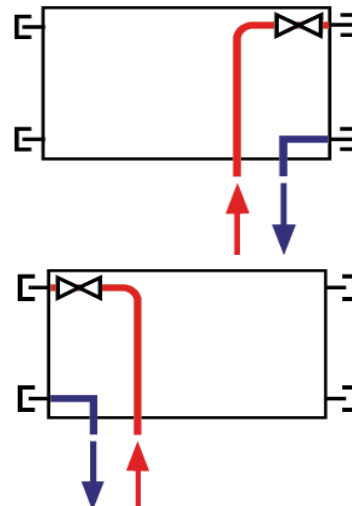

SATIN GLOSS



HIGH GLOSS



MATTE



DEEP MATTE



TIP 10 VKM

TIP 11 VKM

Po naročilu



Režim ogrevanja 20°C:
t1=75°C, t2=65°C



dolžina (mm)	višina (mm)							višina (mm)								
	200	300	400	500	600	700	900	200	300	400	500	600	700	900		
400				132,53	132,53	139,56	149,66				144,61	149,00	165,03	166,24	185,56	184,68
W				229	266	301	369				213	273	332	392	452	573
500		132,53	135,38	136,81	136,81	145,27	156,47				162,17	159,32	171,62	173,15	195,88	198,85
W		188	238	286	333	377	461				267	342	416	490	565	716
600		136,81	138,35	142,63	144,06	152,29	166,46				167,45	168,98	178,43	181,50	208,18	212,57
W		225	286	343	399	452	553				320	410	499	587	677	859
700				146,80	149,66	159,54	173,70				173,15	177,44	187,21	191,71	220,48	227,73
W				400	466	527	645				373	478	582	685	790	1002
800				150,76	155,37	166,46	183,26				180,07	185,78	195,88	200,17	231,13	239,80
W				458	532	602	738				426	546	665	783	903	1146
900				156,47	162,28	173,70	191,71				185,78	194,68	201,70	207,41	243,65	255,39
W				515	599	678	830				480	615	748	881	1016	1289
1000				162,28	167,88	180,62	200,17				193,36	202,47	210,27	217,51	253,97	268,57
W				572	665	753	922				533	683	831	979	1129	1432
1100				167,88	174,91	188,86					200,28	213,89	219,05	227,29	267,14	282,63
W				629	732	828					586	751	914	1077	1242	1575
1200				173,70	180,62	195,88					207,41	224,43	227,73	237,28	279,99	296,68
W				686	798	904					640	820	997	1175	1355	1718
1400				186,22	194,68	210,27					228,60	248,92	245,95	261,87	305,90	333,46
W				801	931	1054					746	956	1163	1371	1581	2005
1600				198,85	207,19	225,64					242,99	271,97	263,41	281,09	328,63	360,03
W				915	1064	1205					853	1093	1330	1566	1806	2291
1800				211,37	222,67	240,90					260,56	295,14	279,66	300,96	353,23	
W				1030	1197	1355					959	1229	1496	1762	2032	
2000				224,10	235,41	256,60					275,38	314,03	297,01	322,81	378,81	
W				1144	1330	1506					1066	1366	1662	1958	2258	
2300													320,62	346,97	412,74	
W													1911	2252	2597	
2600																
W																
3000																
W																

TIP 20 VKM

TIP 21 VKM

Po naročilu



Režim ogrevanja 20°C:
t1=75°C, t2=65°C



dolžina (mm)	višina (mm)							višina (mm)							
	200	300	400	500	600	700	900	200	300	400	500	600	700	900	
400										171,18	174,03	174,36	189,19	206,67	220,70
W										299	375	447	518	586	721
500										181,39	182,93	185,78	202,14	222,88	239,69
W										374	469	559	647	733	901
600										190,28	194,68	199,29	213,56	238,23	260,23
W										449	562	671	776	880	1081
700										198,96	203,24	210,71	227,94	255,62	286,03
W										524	656	783	906	1026	1261
800										207,85	217,18	224,17	240,90	270,55	304,70
W										598	750	894	1035	1173	1442
900										216,53	225,86	235,55	252,65	287,19	325,78
W										673	843	1006	1165	1319	1622
1000										223,77	236,51	247,04	267,14	302,11	343,56
W										748	937	1118	1294	1466	1802
1100										232,34	251,99	260,46	285,15	319,50	363,77
W										823	1031	1230	1423	1613	1982
1200										241,23	267,47	273,45	303,60	336,36	383,75
W										898	1124	1342	1553	1759	2162
1400										273,51	310,95	305,55	332,39	369,43	432,50
W										1047	1312	1565	1812	2052	2523
1600										306,89	348,94	332,39	360,62	401,85	472,80
W										1197	1499	1789	2070	2346	2883
1800										340,38	386,72	357,51	388,43	435,02	
W										1346	1687	2012	2329	2639	
2000										372,33	424,27	383,06	418,17	469,27	
W										1496	1874	2236	2588	2932	
2300													418,92	456,17	515,54
W													2571	2976	3372
2600															
W															
3000															
W															

TIP 22 VKM

TIP 33 VKM

Po naročilu

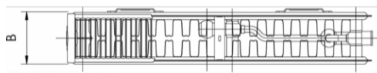

Režim ogrevanja 20°C:
t1=75°C, t2=65°C



dolžina (mm)	višina (mm)							višina (mm)						
	200	300	400	500	600	700	900	200	300	400	500	600	700	900
400	184,46	194,68	185,78	200,82	218,69	231,02					261,21	283,00	299,53	315,66
W	380	482	579	672	762	934					830	964	1090	1314
500	193,03	205,11	200,82	214,77	239,41	258,36					280,85	302,43	316,18	359,32
W	475	602	724	840	953	1168					1038	1206	1362	1643
600	203,24	213,56	213,56	224,21	258,63	282,74					297,71	322,72	355,90	392,92
W	570	722	868	1008	1143	1401					1245	1447	1634	1972
700	218,61	226,52	227,94	242,33	277,96	311,72					316,18	342,69	382,55	427,87
W	665	843	1013	1176	1334	1635					1453	1688	1907	2300
800	229,26	245,40	242,96	260,46	299,10	345,61					291,81	309,03	333,46	363,09
W	760	963	1158	1344	1524	1868					1065	1373	1660	1929
900	240,90	254,63	258,74	273,45	318,54	373,30					305,81	326,24	352,03	383,38
W	855	1084	1302	1512	1715	2102					1198	1544	1868	2170
1000	250,01	267,47	270,44	289,01	340,87	401,31					321,37	343,45	385,56	409,60
W	950	1204	1447	1680	1905	2335					1331	1716	2075	2411
1100	260,23	279,77	285,79	305,22	360,30	424,44					352,79	360,56	408,27	434,20
W	1045	1324	1592	1848	2096	2569					1464	1888	2283	2652
1200	270,66	291,41	301,04	323,80	379,84	447,35					366,99	379,65	430,98	458,81
W	1140	1445	1736	2016	2286	2802					1597	2059	2490	2893
1400	296,13	323,14	338,29	366,31	421,07	502,40					382,55	414,18	472,66	507,52
W	1330	1686	2026	2352	2667	3269					1863	2402	2905	3375
1600	316,99	350,37	366,31	405,50	463,26	550,50					412,21	448,40	516,53	558,55
W	1520	1926	2315	2688	3048	3736					2130	2746	3320	3858
1800	338,62	377,49	397,45	442,22	509,42						443,73	484,28	562,16	605,74
W	1710	2167	2605	3024	3429						2396	3089	3735	4340
2000	356,63	403,30	428,80	480,44	554,19						475,05	518,91	606,13	656,87
W	1900	2408	2894	3360	3810						2662	3432	4150	4822
2300	383,09	426,35	462,29	508,56	608,19						532,81	572,01		
W	2185	2769	3328	3864	4382						3061	3947		
2600	414,71	461,82	504,27	558,70							579,68	623,76		
W	2470	3130	3762	4368	4953						3461	4462		
3000	454,57	509,91	562,78	622,69							645,53	693,96		
W	2850	3612	4341	5040	5715						3993	5148		

Režim ogrevanja 20°C:
t1=75°C, t2=65°C

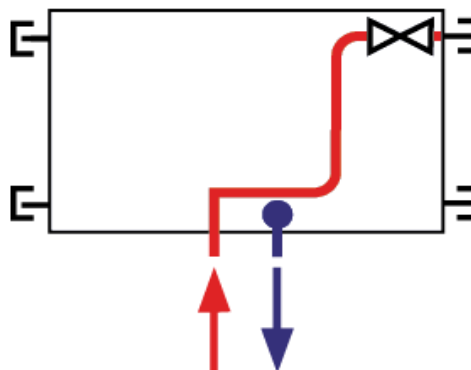
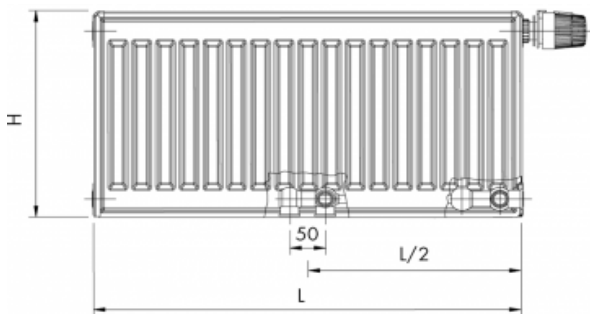

BARVNA LESTVICA: Standardna površinska barva radiatorjev je bela RAL 9016. Doplačilo 30% za drugo barvo s KORADO barvne lestvice (glej www.korado.si). Doplačilo 40% za drugo barvo z RAL lestvice.

SATIN GLOSS



HIGH GLOSS



MATTE



DEEP MATTE



RADIK LINE VERTIKAL - M

Koda	EAN	Naziv	Dimenzije V/Š (mm)	W (Moč)	Cena
10160040-VOL0010	8590822831682	RADIK LINE VERTIKAL-M 10-1600/0400	602		462,834
10160060-VOL0010	8590822831767	RADIK LINE VERTIKAL-M 10-1600/0600	829		541,177
10160090-VOL0010	8590822831842	RADIK LINE VERTIKAL-M 10-1600/0900	1141		626,821
10180040-VOL0010	8590822831705	RADIK LINE VERTIKAL-M 10-1800/0400	661		488,336
10180060-VOL0010	8590822831781	RADIK LINE VERTIKAL-M 10-1800/0600	909		572,140
10180090-VOL0010	8590822831866	RADIK LINE VERTIKAL-M 10-1800/0900	1252		668,709
10200040-VOL0010	8590822831729	RADIK LINE VERTIKAL-M 10-2000/0400	717		515,676
10200060-VOL0010	8590822831804	RADIK LINE VERTIKAL-M 10-2000/0600	986		603,131
10200090-VOL0010	8590822831880	RADIK LINE VERTIKAL-M 10-2000/0900	1358		708,814
20160040-VOL0010	8590822831903	RADIK LINE VERTIKAL-M 20-1600/0400	677		515,676
20160060-VOL0010	8590822831989	RADIK LINE VERTIKAL-M 20-1600/0600	1185		594,018
20160090-VOL0010	8590822832061	RADIK LINE VERTIKAL-M 20-1600/0900	1659		717,927
20180040-VOL0010	8590822831927	RADIK LINE VERTIKAL-M 20-1800/0400	927		552,102
20180060-VOL0010	8590822832009	RADIK LINE VERTIKAL-M 20-1800/0600	1297		632,283
20180090-VOL0010	8590822832085	RADIK LINE VERTIKAL-M 20-1800/0900	1815		785,345
20200040-VOL0010	8590822831941	RADIK LINE VERTIKAL-M 20-2000/0400	1004		588,555
20200060-VOL0010	8590822832023	RADIK LINE VERTIKAL-M 20-2000/0600	1404		672,360
20200090-VOL0010	8590822832108	RADIK LINE VERTIKAL-M 20-2000/0900	1965		854,573

Režim ogrevanja 20°C: t1=75°C, t2=65°C

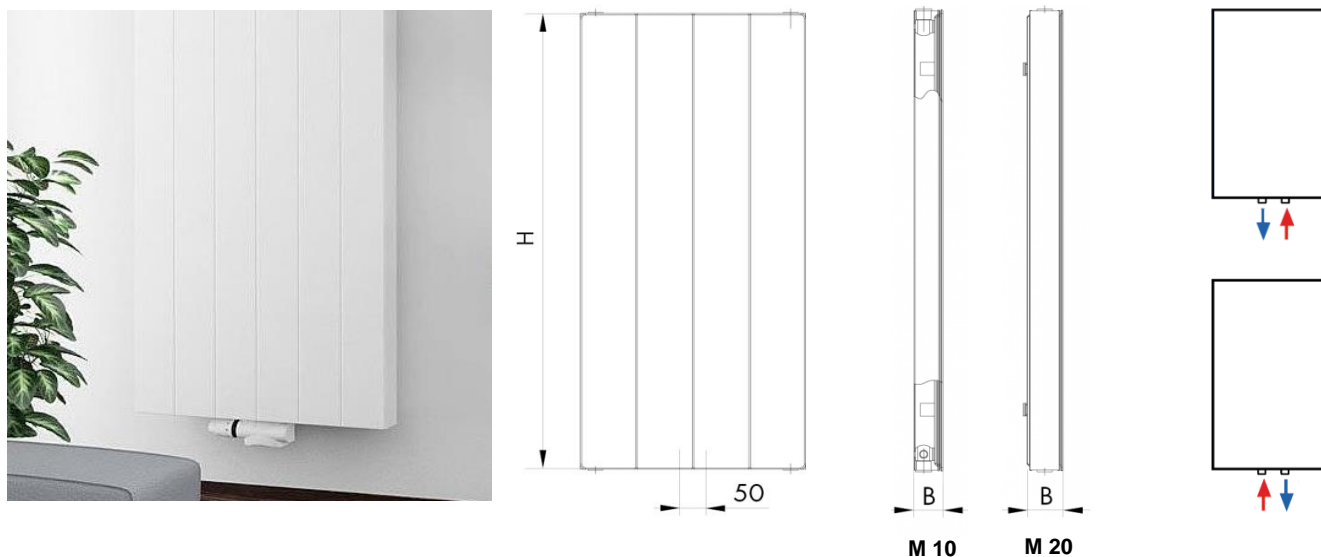

BARVNA LESTVICA: Standardna površinska barva radiatorjev je bela RAL 9016.

Doplačilo 30% za drugo barvo s KORADO barvne lestvice (glej www.korado.si). Doplačilo 40% za drugo barvo z RAL lestvice.

SATIN GLOSS



HIGH GLOSS



MATTE



DEEP MATTE



RADIK PLAN VERTIKAL - M

Koda	EAN	Naziv	Dimenzije V/Š (mm)	W (Moč)	Cena
10160040-V0P0010	8590822732224	RADIK PLAN VERTIKAL-M 10-1600/0400	602	462,83	
10160060-V0P0010	8590822732309	RADIK PLAN VERTIKAL-M 10-1600/0600	829	541,18	
10160090-V0P0010	8590822732385	RADIK PLAN VERTIKAL-M 10-1600/0900	1141	626,82	
10180040-V0P0010	8590822732248	RADIK PLAN VERTIKAL-M 10-1800/0400	661	488,34	
10180060-V0P0010	8590822732323	RADIK PLAN VERTIKAL-M 10-1800/0600	909	572,14	
10180090-V0P0010	8590822732408	RADIK PLAN VERTIKAL-M 10-1800/0900	1252	668,71	
10200040-V0P0010	8590822732262	RADIK PLAN VERTIKAL-M 10-2000/0400	717	515,68	
10200060-V0P0010	8590822732347	RADIK PLAN VERTIKAL-M 10-2000/0600	986	603,13	
10200090-V0P0010	8590822732422	RADIK PLAN VERTIKAL-M 10-2000/0900	1358	708,81	
20160040-V0P0010	8590822732446	RADIK PLAN VERTIKAL-M 20-1600/0400	677	515,68	
20160060-V0P0010	8590822732521	RADIK PLAN VERTIKAL-M 20-1600/0600	1185	594,02	
20160090-V0P0010	8590822732606	RADIK PLAN VERTIKAL-M 20-1600/0900	1659	717,93	
20180040-V0P0010	8590822732460	RADIK PLAN VERTIKAL-M 20-1800/0400	927	552,10	
20180060-V0P0010	8590822732545	RADIK PLAN VERTIKAL-M 20-1800/0600	1297	632,28	
20180090-V0P0010	8590822732620	RADIK PLAN VERTIKAL-M 20-1800/0900	1815	785,34	
20200040-V0P0010	8590822732484	RADIK PLAN VERTIKAL-M 20-2000/0400	1004	588,56	
20200060-V0P0010	8590822732569	RADIK PLAN VERTIKAL-M 20-2000/0600	1404	672,36	
20200090-V0P0010	8590822732644	RADIK PLAN VERTIKAL-M 20-2000/0900	1965	854,57	

Režim ogrevanja 20°C: t1=75°C, t2=65°C

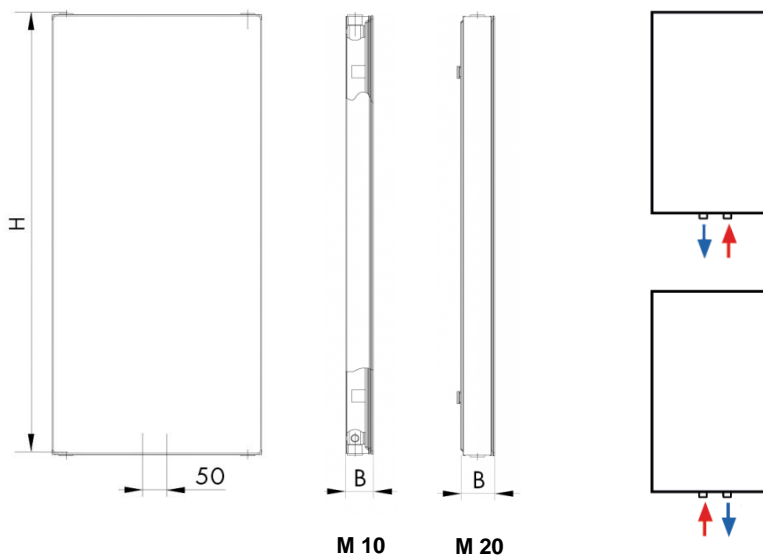
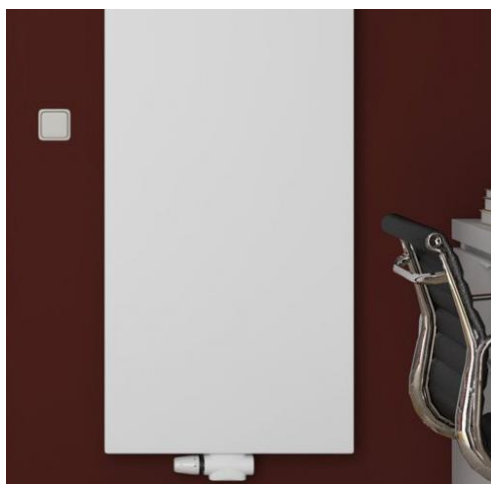

BARVNA LESTVICA: Standardna površinska barva radiatorjev je bela RAL 9016.

Doplačilo 30% za drugo barvo s KORADO barvne lestvice (glej www.korado.si). Doplačilo 40% za drugo barvo z RAL lestvice.

SATIN GLOSS



HIGH GLOSS



MATTE



DEEP MATTE



Po naročilu		KORATHERM HORIZONTAL - TIP 10								KORATHERM HORIZONTAL - TIP 11							
dolžina (mm)	višina (mm)								višina (mm)								
	144	218	366	514	588	662	884	958	144	218	366	514	588	662	884	958	
500	118,36	141,20	184,80	229,45	251,25	274,09	340,54	362,34	148,47	174,42	226,33	277,20	303,16	329,12	406,98	432,94	
W	100	133	198	264	298	333	449	491	145	206	319	424	475	524	666	712	
600	124,59	148,47	197,26	245,02	268,90	292,78	365,45	389,33	155,73	183,76	239,83	295,89	323,92	351,96	436,05	464,08	
W	119	160	237	316	357	400	539	589	173	247	383	509	569	629	799	854	
700	130,82	156,77	208,68	260,59	286,55	311,47	389,33	415,29	164,04	194,15	254,36	314,58	344,69	375,84	466,16	496,27	
W	139	186	277	369	417	466	629	687	202	288	447	594	664	734	932	996	
800	137,05	165,08	220,10	275,13	303,16	331,19	414,25	441,24	171,31	203,49	268,90	333,27	366,49	398,68	496,27	528,45	
W	159	213	316	422	476	533	718	786	231	329	510	678	759	838	1066	1138	
900	143,27	172,34	231,52	290,70	320,81	349,88	438,13	468,24	178,57	213,87	283,43	351,96	387,26	421,52	525,34	560,64	
W	179	239	356	474	536	599	808	884	260	370	574	763	854	943	1199	1281	
1000	149,50	180,65	242,94	306,27	337,42	368,57	463,05	494,19	186,88	223,22	296,93	370,64	408,02	444,36	555,45	591,79	
W	199	266	395	527	595	666	898	982	289	411	638	848	949	1048	1332	1423	
1100	155,73	188,96	255,40	321,85	355,07	388,29	486,93	520,15	194,15	233,60	311,47	389,33	428,78	468,24	584,52	623,97	
W	219	293	435	580	655	733	988	1080	318	452	702	933	1044	1153	1465	1565	
1200	161,96	196,22	266,82	336,38	371,68	406,98	511,84	547,14	202,45	242,94	326,00	408,02	449,55	491,08	614,63	656,16	
W	239	319	474	632	714	799	1078	1178	347	493	766	1018	1139	1258	1598	1708	
1400	174,42	212,84	289,66	367,53	405,94	444,36	560,64	599,05	216,99	262,67	354,03	445,40	491,08	536,76	673,80	719,49	
W	279	372	553	738	833	932	1257	1375	405	575	893	1187	1329	1467	1865	1992	
1600	185,84	228,41	313,54	397,64	440,21	482,77	609,44	652,00	232,56	283,43	383,10	482,77	533,65	583,48	732,98	783,86	
W	318	426	632	843	952	1066	1437	1571	462	658	1021	1357	1518	1677	2131	2277	
1800	198,30	245,02	336,38	428,78	474,47	520,15	658,23	704,95	248,13	303,16	411,14	520,15	575,17	629,16	793,20	847,19	
W	358	479	711	949	1071	1199	1616	1768	520	740	1148	1526	1708	1886	2398	2561	
2000	210,76	260,59	360,26	458,89	508,73	558,56	708,07	756,86	263,71	322,89	440,21	557,52	616,70	675,88	852,38	910,52	
W	398	532	790	1054	1190	1332	1796	1964	578	822	1276	1696	1898	2096	2664	2846	
2300	229,45	284,47	394,52	505,61	560,64	615,66	780,74	835,77	286,55	351,96	482,77	613,59	679,00	744,40	941,67	1.007,07	
W	458	612	909	1212	1369	1532	2065	2259	665	945	1467	1950	2183	2410	3064	3273	
2600	248,13	308,35	429,82	551,29	611,51	672,77	854,46	915,71	309,39	382,06	526,38	669,65	742,33	813,96	1.029,91	1.102,59	
W	517	692	1027	1370	1547	1732	2335	2553	751	1069	1659	2205	2467	2725	3463	3700	
3000	272,01	340,54	476,54	612,55	680,03	748,56	952,05	1.020,57	340,54	421,52	583,48	744,40	825,38	906,37	1.149,31		
W	597	798	1185	1581	1785	1998	2694	2946	867	1233	1914	2544	2847	3144	3996		

Po naročilu		KORATHERM HORIZONTAL - TIP 20								KORATHERM HORIZONTAL - TIP 21							
dolžina (mm)	višina (mm)								višina (mm)								
	144	218	366	514	588	662	884	958	144	218	366	514	588	662	884	958	
500	250,21	294,85	385,18	476,54	521,19	566,87	702,87	747,52	270,98	320,81	419,44	518,07	567,91	617,74	766,21	815,00	
W	159	220	334	446	503	560	738	800	209	291	436	564	624	680	837	886	
600	262,67	311,47	410,10	507,69	556,49	606,32	752,71	801,51	286,55	340,54	448,51	556,49	610,47	664,46	826,42	880,41	
W	191	263	400	535	604	672	886	959	250	349	523	677	748	816	1004	1063	
700	276,17	329,12	433,98	539,87	592,82	644,73	803,58	855,49	302,12	360,26	477,58						

KORATHERM HORIZONTAL - TIP 22									
dolžina (mm)	višina (mm)								
	144	218	366	514	588	662	884	958	
500	306,27	358,19	463,05	568,94	620,86	673,80	830,58	883,53	
W	267	375	604	777	854	927	1119	1176	
600	323,92	381,03	495,23	609,44	666,54	723,64	895,98	953,09	
W	320	449	724	932	1025	1112	1343	1411	
700	340,54	402,83	526,38	650,96	713,26	774,51	960,35	1.022,65	
W	374	524	845	1088	1196	1297	1567	1646	
800	358,19	424,63	558,56	691,45	758,94	825,38	1.025,76	1.092,21	
W	427	599	966	1243	1366	1482	1790	1881	
900	375,84	447,47	589,71	732,98	804,62	876,26	1.090,13	1.161,77	
W	481	674	1086	1399	1537	1668	2014	2116	
1000	392,45	469,28	621,89	774,51	850,30	927,13	1.155,54	1.231,33	
W	534	749	1207	1554	1708	1853	2238	2351	
1100	410,10	491,08	653,04	815,00	895,98	976,97	1.220,95	1.300,89	
W	587	824	1328	1709	1879	2038	2462	2586	
1200	427,75	513,92	685,23	856,53	942,70	1.027,84	1.285,32	1.371,49	
W	641	899	1448	1865	2050	2224	2686	2821	
1400	462,01	557,52	748,56	938,55	1.034,07	1.129,58	1.415,09	1.510,61	
W	748	1049	1690	2176	2391	2594	3133	3291	
1600	497,31	602,17	811,89	1.021,61	1.125,43	1.230,29			
W	854	1198	1931	2486	2733	2965			
1800	531,57	645,77	875,22	1.103,63	1.217,83	1.332,04			
W	961	1348	2173	2797	3074	3335			
2000	566,87	690,42	938,55	1.185,65	1.309,20	1.433,78			
W	1068	1498	2414	3108	3416	3706			
2300	618,78	756,86	1.033,03	1.309,20	1.447,28				
W	1228	1723	2776	3574	3928				
2600	670,69	823,31	1.127,51	1.432,74					
W	1388	1947	3138	4040					
3000	740,25	911,56	1.254,17						
W	1602	2247	3621						

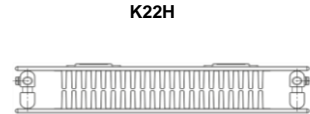
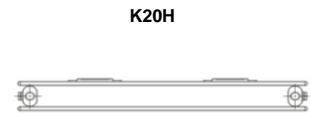

Režim ogrevanja 20°C: t1=75°C, t2=65°C

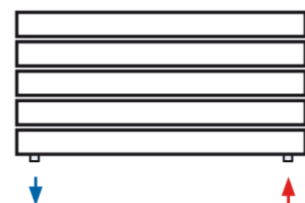
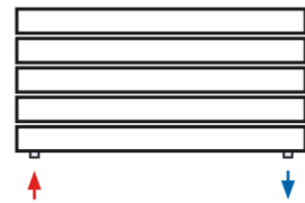
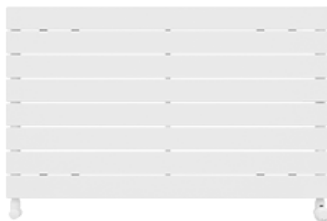

BARVNA LESTVICA: Standardna površinska barva radiatorjev je bela RAL 9016.

Doplačilo 30% za drugo barvo s KORADO barvne lestvice (glej www.korado.si). Doplačilo 40% za drugo barvo z RAL lestvice.

SATIN GLOSS



HIGH GLOSS



MATTE

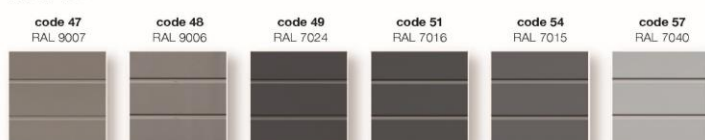

DEEP MATTE



Po naročilu

Režim ogrevanja 20°C: t1=75°C, t2=65°C

KORATHERM HORIZONTAL VKM - TIP 11

KORATHERM HORIZONTAL VKM - TIP 20

dolžina (mm)	višina (mm)						višina (mm)					
	218	366	514	588	662	884	218	366	514	588	662	884
500							494,19	585,56	630,20	675,88	811,89	
W							371	495	556	618	805	
600	348,84	404,91	432,94	460,97	545,07		519,11	616,70	665,50	715,33	861,72	
W	383	509	569	629	799		445	593	667	741	966	
700	363,38	423,59	453,70	484,85	575,17		542,99	648,89	701,84	753,75	912,60	
W	447	594	664	734	932		519	692	778	865	1127	
800	377,91	442,28	475,50	507,69	605,28		567,91	680,03	737,14	793,20	962,43	
W	510	678	759	838	1066		594	791	890	988	1288	
900	392,45	460,97	496,27	530,53	634,35		591,79	712,22	772,44	832,65	1.013,30	
W	574	763	854	943	1199		668	890	1001	1112	1449	
1000	405,94	479,66	517,03	553,37	664,46		615,66	743,37	807,74	872,10	1.063,14	
W	638	848	949	1048	1332		742	989	1112	1235	1610	
1100	420,48	498,35	537,80	577,25	693,53		640,58	775,55	843,03	910,52	1.114,01	
W	702	933	1044	1153	1465		816	1088	1223	1359	1771	
1200	435,01	517,03	558,56	600,09	723,64		664,46	807,74	878,33	949,97	1.164,88	
W	766	1018	1139	1258	1598		890	1187	1334	1482	1932	
1400	463,05	554,41	600,09	645,77	782,82		713,26	871,07	949,97	1.028,88	1.265,59	
W	893	1187	1329	1467	1865		1039	1385	1557	1729	2254	
1600	492,12	591,79	642,66	692,49	842,00		761,02	934,40	1.020,57	1.106,74	1.366,30	
W	1021	1357	1518	1677	2131		1187	1582	1779	1976	2576	
1800	520,15	629,16	684,19	738,17	902,21		809,81	997,73	1.091,17	1.185,65	1.467,00	
W	1148	1526	1708	1886	2398		1336	1780	2002	2223	2898	
2000	549,22	666,54	725,72	784,89	961,39		858,61	1.061,06	1.162,81	1.263,51	1.567,71	
W	1276	1696	1898	2096	2664		1484	1978	2224	2470	3220	

KORATHERM HORIZONTAL VKM - TIP 21

KORATHERM HORIZONTAL VKM - TIP 22

dolžina (mm)	višina (mm)						višina (mm)					
	218	366	514	588	662	884	218	366	514	588	662	884
500	429,82	528,45	627,08	676,92	726,75	875,22	467,20	572,06	677,96	729,87	782,82	939,59
W	291	436	564	624	680	837	375	604	777	854	927	1119
600	449,55	557,52	665,50	719,49	773,47	935,44	490,04	604,24	718,45	775,55	832,65	1.005,00
W	349	523	677	748	816	1004	449	724	932	1025	1112	1343
700	469,28	586,59	702,87	762,05	820,19	995,65	511,84	635,39	759,98	822,27	883,53	1.069,37
W	407	610	790	873	952	1172	524	845	1088	1196	1297	1567
800	489,00	614,63	741,29	803,58	866,91	1.055,87	533,65	667,58	800,47	867,95	934,40	1.134,77
W	465	697	902	998	1088	1339	599	966	1243	1366	1482	1790
900	508,73	643,70	778,67	846,15	913,63	1.116,09	556,49	698,72	842,00	913,63	985,27	1.199,14
W	523	784	1015	1122	1224	1507	674	1086	1399	1537	1668	2014
1000	528,45	672,77	816,04	888,72	960,35	1.176,30	578,29	730,91	883,53	959,32	1.036,14	1.264,55
W	581	871	1128	1247	1360	1674	749	1207	1554	1708	1853	2238
1100	548,18	701,84	854,46	931,28	1.007,07	1.236,52	600,09	762,05	924,02	1.005,00	1.085,98	1.329,96
W	639	958	1241	1372	1496	1841	824	1328	1709	1879	2038	2462
1200	568,94	729,87	891,83	972,81	1.053,79	1.296,74	622,93	794,24	965,54	1.051,72	1.136,85	1.394,33
W	697	1045	1354	1496	1632	2009	899	1448	1865	2050	2224	2686
1400	608,40	788,01	967,62	1.057,95	1.147,23	1.417,17	666,54	857,57	1.047,56	1.143,08	1.238,60	1.524,11
W	813	1219	1579	1746	1904	2344	1049	1690	2176	2391	2594	3133
1600	647,85	846,15	1.043,41	1.142,04	1.240,67	1.537,60	711,18	920,90	1.130,62	1.234,44	1.339,30	
W	930	1394	1805	1995	2176	2678	1198	1931	2486	2733	2965	
1800	687,30	903,25	1.119,20	1.227,18	1.335,15	1.658,04	754,79	984,23	1.212,64	1.326,85	1.441,05	
W	1046	1568	2030	2245	2448	3013	1348	2173	2797	3074	3335	
2000	727,79	961,39	1.194,99	1.311,27	1.428,59		799,43	1.047,56	1.294,66	1.418,21	1.542,79	
W	1162	1742	2256	2494	2720		1498	2414	3108	3416	3706	

KORATHERM VERTIKAL - TIP 10										KORATHERM VERTIKAL - TIP 11							
višina (mm)	širina (mm)									širina (mm)							
	144	218	366	514	588	662	884	958		144	218	366	514	588	662	884	958
500	147,43	169,23	213,87	258,52	281,36	303,16	370,64	392,45		177,54	203,49	255,40	307,31	333,27	359,22	438,13	464,08
W	90	136	229	322	368	414	553	600		118	179	301	423	483	544	727	787
600	153,66	177,54	226,33	274,09	299,01	322,89	395,56	419,44		184,80	213,87	269,94	326,00	355,07	383,10	467,20	496,27
W	107	162	272	382	437	492	657	712		139	210	353	495	567	638	852	924
700	159,89	185,84	237,75	289,66	315,62	341,57	419,44	446,43		193,11	223,22	284,47	345,73	375,84	405,94	497,31	528,45
W	124	187	315	442	506	569	760	824		159	240	403	566	648	730	974	1056
800	166,12	194,15	249,17	305,24	333,27	361,30	444,36	472,39		200,38	233,60	299,01	364,42	396,60	429,82	527,42	560,64
W	141	213	358	502	574	647	864	936		178	270	453	636	727	819	1094	1185
900	172,34	201,41	261,63	320,81	349,88	379,99	469,28	499,38		208,68	242,94	313,54	383,10	417,36	452,66	557,52	592,82
W	157	238	400	562	643	724	966	1047		197	298	501	704	805	906	1210	1312
1000	178,57	209,72	273,05	336,38	367,53	399,71	494,19	525,34		215,95	253,33	328,08	401,79	439,17	475,50	587,63	
W	174	263	442	621	710	800	1068	1157		216	327	548	770	881	992	1324	
1100	184,80	218,03	284,47	351,96	385,18	418,40	519,11	552,33		224,26	263,71	341,57	420,48	459,93	499,38	617,74	
W	191	289	485	681	779	876	1170	1268		234	354	595	836	956	1076	1437	
1200	191,03	226,33	296,93	366,49	401,79	437,09	542,99	578,29		231,52	273,05	356,11	439,17	480,70	522,22	646,81	
W	207	314	527	740	846	953	1272	1379		252	382	641	900	1030	1159	1548	
1400	203,49	241,91	319,77	397,64	437,09	475,50	592,82	631,24		247,10	292,78	385,18	477,58	523,26	568,94	707,03	
W	240	364	611	858	982	1106	1476	1600		287	435	731	1026	1174	1321	1764	
1600	215,95	258,52	343,65	428,78	471,35	513,92	641,62	685,23		262,67	313,54	414,25	514,96	564,79	615,66	767,24	
W	274	414	695	977	1117	1258	1680	1820		322	487	818	1148	1314	1479	1975	
1800	227,37	274,09	366,49	459,93	505,61	552,33	691,45	738,17		278,24	333,27	443,32	552,33	607,36	662,38	826,42	
W	307	465	780	1095	1253	1411	1884	2041		355	538	903	1268	1450	1632	2180	
2000	239,83	290,70	390,37	490,04	540,91	590,75	741,29	791,12		293,82	352,99	471,35	590,75	649,93	709,10	886,64	
W	340	515	865	1215	1389	1564	2089	2264		388	587	985	1384	1583	1782	2380	

KORATHERM VERTIKAL - TIP 20									
višina (mm)	širina (mm)								
	144	218	366	514	588	662	884	958	
500	281,36	327,04	418,40	508,73	554,41	600,09	737,14	782,82	
W	137	207	348	489	559	630	841	911	
600	293,82	343,65	442,28	540,91	590,75	639,54	788,01	837,84	
W	161	244	410	576	659	742	991	1074	
700	307,31	360,26	467,20	573,10	626,05	679,00	838,88	891,83	
W	185	281	471	662	757	853	1139	1234	
800	320,81	377,91	491,08	605,28	662,38	719,49	889,75	946,86	
W	209	317	532	747	854	962	1284	1392	
900	333,27	394,52	516,00	637,47	697,68	758,94	940,63	1.000,84	
W	233	352	591	831	950	1070	1429	1548	
1000	346,77	411,14	539,87	669,65	734,02	798,39	991,50	1.055,87	
W	256	387	650	913	1045	1176	1571	1702	
1100	360,26	428,78	564,79	700,80	769,32	837,84	1.042,37	1.110,90	
W	279	422	709	996	1139	1282	1712	1856	
1200	373,76	445,40	589,71	732,98	805,66	877,30	1.093,25	1.164,88	
W	302	457	767	1077	1232	1387	1852	2007	
1400	399,71	478,62	638,51	797,35	876,26	956,20	1.194,99	1.273,90	
W	347	525	881	1237	1415	1593	2128	2306	
1600	425,67	512,88	687,30	860,68	947,89	1.035,11	1.296,74	1.383,95	
W	391	592	994	1396	1596	1797	2400	2601	
1800	452,66	547,14	736,10	925,05	1.019,53	1.114,01	1.398,48	1.492,96	
W	435	658	1105	1552	1775	1999	2669	2892	
2000	478,62	580,36	784,89	989,42	1.091,17	1.192,91	1.500,23		
W	478	724	1215	1706	1952	2198	2935		

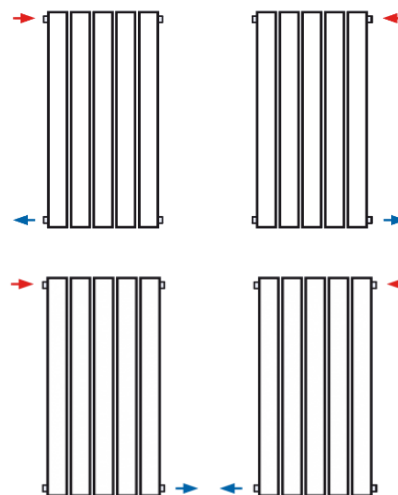
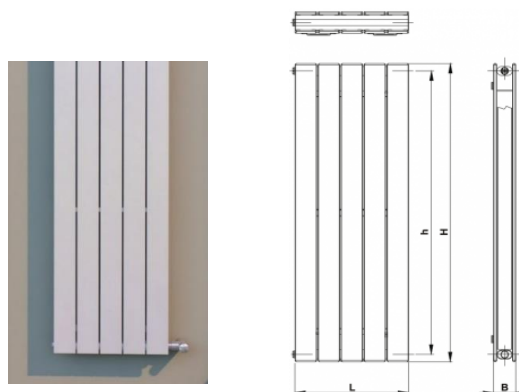

SATIN GLOSS



MATTE



DEEP MATTE



BARVNA LESTVICA: Standardna površinska barva radiatorjev je bela RAL 9016.

Doplačilo 30% za drugo barvo s KORADO barvne lestvice (glej www.korado.si).

Doplačilo 40% za drugo barvo z RAL lestvice.

Po naročilu

Režim ogrevanja 20°C: t1=75°C, t2=65°C

KORATHERM VERTIKAL M - TIP 10										KORATHERM VERTIKAL M - TIP 11							
višina (mm)	dolžina (mm)									dolžina (mm)							
	144	218	366	514	588	662	884	958		144	218	366	514	588	662	884	958
500	175,46	197,26	241,91	286,55	309,39	331,19	398,68	420,48		205,57	231,52	283,43	335,35	361,30	387,26	466,16	492,12
W	90	136	229	322	368	414	553	600		118	179	301	423	483	544	727	787
600	181,69	205,57	254,36	302,12	327,04	350,92	423,59	447,47		212,84	241,91	297,97	354,03	383,10	411,14	495,23	524,30
W	107	162	272	382	437	492	657	712		139	210	353	495	567	638	852	924
700	187,92	213,87	265,78	317,70	343,65	369,61	447,47	474,47		221,14	251,25	312,50	373,76	403,87	433,98	525,34	556,49
W	124	187	315	442	506	569	760	824		159	240	403	566	648	730	974	1056
800	194,15	222,18	277,20	333,27	361,30	389,33	472,39	500,42		228,41	261,63	327,04	392,45	424,63	457,86	555,45	588,67
W	141	213	358	502	574	647	864	936		178	270	453	636	727	819	1094	1185
900	200,38	229,45	289,66	348,84	377,91	408,02	497,31	527,42		236,71	270,98	341,57	411,14	445,40	480,70	585,56	620,86
W	157	238	400	562	643	724	966	1047		197	298	501	704	805	906	1210	1312
1000	206,61	237,75	301,08	364,42	395,56	427,75	522,22	553,37		243,98	281,36	356,11	429,82	467,20	503,54	615,66	
W	174	263	442	621	710	800	1068	1157		216	327	548	770	881	992	1324	
1100	212,84	246,06	312,50	379,99	413,21	446,43	547,14	580,36		252,29	291,74	369,61	448,51	487,96	527,42	645,77	
W	191	289	485	681	779	876	1170	1268		234	354	595	836	956	1076	1437	
1200	219,06	254,36	324,96	394,52	429,82	465,12	571,02	606,32		259,56	301,08	384,14	467,20	508,73	550,26	674,84	
W	207	314	527	740	846	953	1272	1379		252	382	641	900	1030	1159	1548	
1400	231,52	269,94	347,80	425,67	465,12	503,54	620,86	659,27		275,13	320,81	413,21	505,61	551,29	596,98	735,06	
W	240	364	611	858	982	1106	1476	1600		287	435	731	1026	1174	1321	1764	
1600	243,98	286,55	371,68	456,82	499,38	541,95	669,65	713,26		290,70	341,57	442,28	542,99	592,82	643,70	795,28	
W	274	414	695	977	1117	1258	1680	1820		322	487	818	1148	1314	1479	1975	
1800	255,40	302,12	394,52	487,96	533,65	580,36	719,49	766,21		306,27	361,30	471,35	580,36	635,39	690,42	854,46	
W	307	465	780	1095	1253	1411	1884	2041		355	538	903	1268	1450	1632	2180	
2000	267,86	318,73	418,40	518,07	568,94	618,78	769,32	819,16		321,85	381,03	499,38	618,78	677,96	737,14	914,67	
W	340	515	865	1215	1389	1564	2089	2264		388	587	985	1384	1583	1782	2380	

KORATHERM VERTIKAL M - TIP 20									
višina (mm)	dolžina (mm)								
	144	218	366	514	588	662	884	958	
500	309,39	355,07	446,43	536,76	582,44	628,12	765,17	810,85	
W	137	207	348	489	559	630	841	911	
600	321,85	371,68	470,31	568,94	618,78	667,58	816,04	865,88	
W	161	244	410	576	659	742	991	1074	
700	335,35	388,29	495,23	601,13	654,08	707,03	866,91	919,86	
W	185	281	471	662	757	853	1139	1234	
800	348,84	405,94	519,11	633,31	690,42	747,52	917,79	974,89	
W	209	317	532	747	854	962	1284	1392	
900	361,30	422,56	544,03	665,50	725,72	786,97	968,66	1.028,88	
W	233	352	591	831	950	1070	1429	1548	
1000	374,80	439,17	567,91	697,68	762,05	826,42	1.019,53	1.083,90	
W	256	387	650	913	1045	1176	1571	1702	
1100	388,29	456,82	592,82	728,83	797,35	865,88	1.070,40	1.138,93	
W	279	422	709	996	1139	1282	1712	1856	
1200	401,79	473,43	617,74	761,02	833,69	905,33	1.121,28	1.192,91	
W	302	457	767	1077	1232	1387	1852	2007	
1400	427,75	506,65	666,54	825,38	904,29	984,23	1.223,02	1.301,93	
W	347	525	881	1237	1415	1593	2128	2306	
1600	453,70	540,91	715,33	888,72	975,93	1.063,14	1.324,77	1.411,98	
W	391	592	994	1396	1596	1797	2400	2601	
1800	480,70	575,17	764,13	953,09	1.047,56	1.142,04	1.426,51	1.520,99	
W	435	658	1105	1552	1775	1999	2669	2892	
2000	506,65	608,40	812,93	1.017,46	1.119,20	1.220,95	1.528,26		
W	478	724	1215	1706	1952	2198	2935		

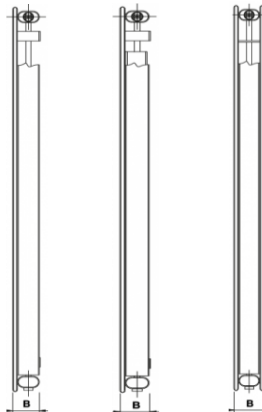
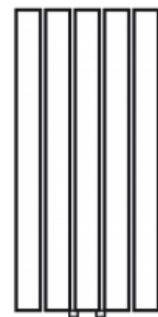
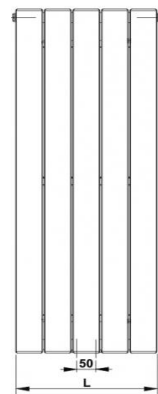

K10VM

K11VM

K20VM

SATIN GLOSS

HIGH GLOSS



MATTE

DEEP MATTE



BARVNA LESTVICA: Standardna površinska barva radiatorjev je bela RAL 9016.

Doplačilo 30% za drugo barvo s KORADO barvne lestvice (glej www.korado.si).

Doplačilo 40% za drugo barvo z RAL lestvice.

Po naročilu

RADIATOR KORATHERM REFLEX Z OGLEDALOM



TIP 10



TIP 20



TIP 10



TIP 20

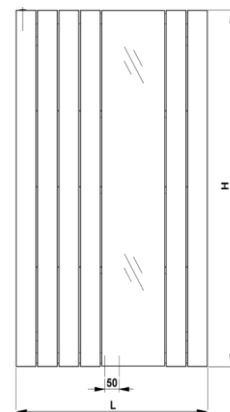

VRSTE PRIKLOPA

REFLEX

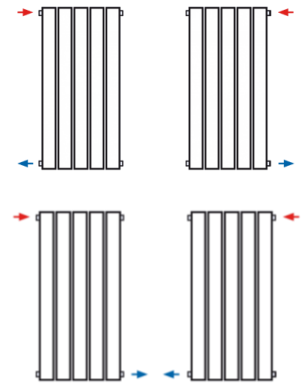

REFLEX-M

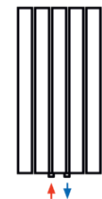

Režim ogrevanja 20°C:
t1=70°C, t2=65°C

višina (mm)	TIP 10 dolžina (mm)				TIP 20 dolžina (mm)			
	514	662	810	958	514	662	884	958
1800	403,14	521,05	619,87	708,60	744,52	951,15	1.148,78	1.321,74
W	791	1086	1381	1676	1415	1877	2339	2811

BARVNA LESTVICA: Standardna površinska barva radiatorjev je bela RAL 9016. Doplačilo 30% za drugo barvo s KORADO barvne lestvice (glej www.korado.si). Doplačilo 40% za drugo barvo z RAL lestvice.

SATIN GLOSS



HIGH GLOSS



MATTE



DEEP MATTE

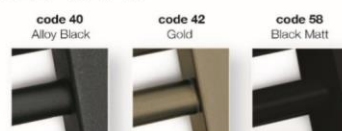

KORALUX NEO WHITE

Koda	EAN	Naziv	V(mm)	Š(mm)	d(mm)	W (Moč)	Cena
KLN-110050-00-10	8592651664301	KORALUX NEO 1100/0500	1095	496	50	520	501,57
KLN-110060-00-10	8592651664318	KORALUX NEO 1100/0600	1095	596	50	593	559,24
KLN-142050-00-10	8592651664325	KORALUX NEO 1420/0500	1415	496	50	670	618,36
KLN-142060-00-10	8592651664332	KORALUX NEO 1420/0600	1415	596	50	763	676,02
KLN-170050-00-10	8592651664349	KORALUX NEO 1700/0500	1695	496	50	803	709,67
KLN-170060-00-10	8592651664356	KORALUX NEO 1700/0600	1695	596	50	914	769,15

Režim ogrevanja 20°C: t1=75°C, t2=65°C

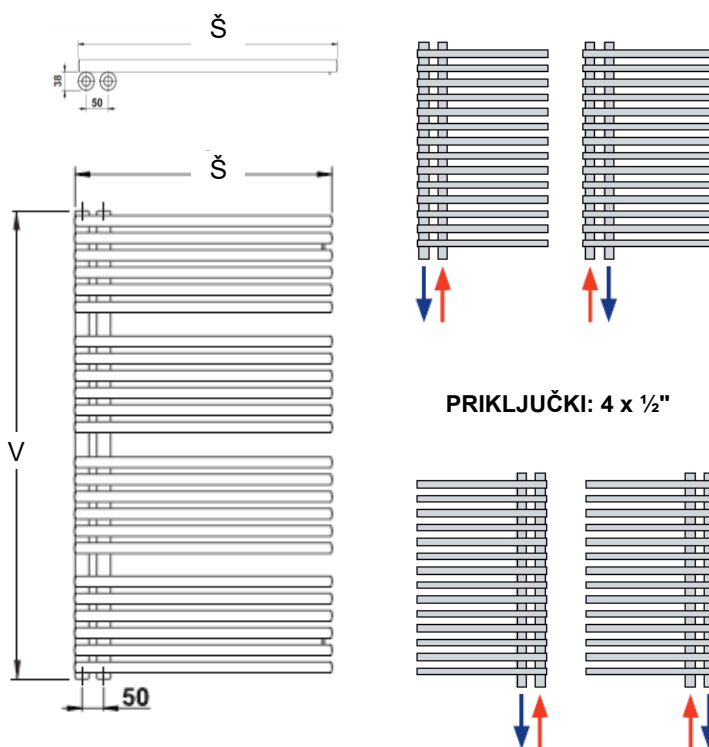

BARVNA LESTVICA: Standardna površinska barva radiatorjev je bela RAL 9016. Doplačilo 20% za drugo barvo s KORADO barvne lestvice (glej www.korado.si). Doplačilo 30% za drugo barvo z RAL lestvice.

SATIN GLOSS



HIGH GLOSS



MATTE



DEEP MATTE



Režim ogrevanja 20°C: t1=75°C, t2=65°C

KORALUX LINEAR COMFORT

Koda	Višina (h)	Širina (mm)	Moč (W)	Cena
KLT07000450-10	700	450	312	109,56
KLT07000500-10	700	500	342	111,63
KLT07000600-10	700	600	400	115,17
KLT07000750-10	700	750	485	120,90
KLT09000450-10	900	450	402	124,81
KLT09000500-10	900	500	440	127,73
KLT09000600-10	900	600	515	132,86
KLT09000750-10	900	750	624	141,52
KLT12200450-10	1220	450	549	149,33
KLT12200500-10	1220	500	601	153,48
KLT12200600-10	1220	600	703	161,65
KLT12200750-10	1220	750	852	174,22
KLT15000450-10	1500	450	682	171,17
KLT15000500-10	1500	500	747	176,05
KLT15000600-10	1500	600	874	186,78
KLT15000750-10	1500	750	1060	202,89
KLT18200450-10	1820	450	841	195,44
KLT18200500-10	1820	500	921	202,28
KLT18200600-10	1820	600	1078	215,33
KLT18200750-10	1820	750	1307	235,46

KORALUX LINEAR COMFORT- M

Koda	Višina (h)	Širina (mm)	Moč (W)	Cena
KLT07000450M10	700	450	287	146,03
KLT07000500M10	700	500	315	147,74
KLT07000600M10	700	600	370	151,28
KLT07000750M10	700	750	450	157,01
KLT09000450M10	900	450	369	161,04
KLT09000500M10	900	500	405	163,97
KLT09000600M10	900	600	475	169,09
KLT09000750M10	900	750	579	177,51
KLT12200450M10	1220	450	504	185,81
KLT12200500M10	1220	500	553	189,83
KLT12200600M10	1220	600	650	197,76
KLT12200750M10	1220	750	791	210,08
KLT15000450M10	1500	450	626	206,91
KLT15000500M10	1500	500	687	212,28
KLT15000600M10	1500	600	808	222,89
KLT15000750M10	1500	750	984	238,75
KLT18200450M10	1820	450	772	231,43
KLT18200500M10	1820	500	848	238,39
KLT18200600M10	1820	600	996	251,32
KLT18200750M10	1820	750	1213	271,57

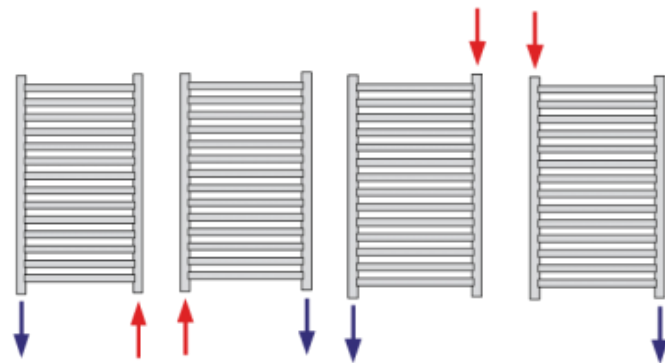

BARVNA LESTVICA: Standardna površinska barva radiatorjev je bela RAL 9016. Doplacilo 20% za drugo barvo s KORADO barvne lestvice (glej www.korado.si). Doplacilo 40% za drugo barvo z RAL lestvice.

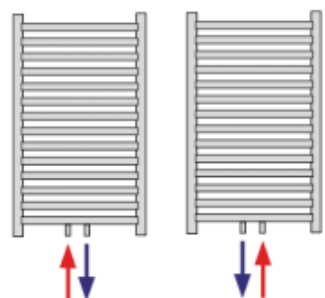

Režim ogrevanja 20°C: t1=75°C, t2=65°C

KORALUX RONDO COMFORT

Koda	Višina (h)	Širina (mm)	Moč (W)	Cena
KRT07000450-10	700	450	312	112,85
KRT07000500-10	700	500	342	114,68
KRT07000600-10	700	600	400	118,46
KRT07000750-10	700	750	485	124,32
KRT09000450-10	900	450	402	128,71
KRT09000500-10	900	500	440	131,39
KRT09000600-10	900	600	515	136,88
KRT09000750-10	900	750	624	145,55
KRT12200450-10	1220	450	549	153,96
KRT12200500-10	1220	500	601	157,99
KRT12200600-10	1220	600	703	166,53
KRT12200750-10	1220	750	852	179,34
KRT15000450-10	1500	450	682	175,92
KRT15000500-10	1500	500	747	181,54
KRT15000600-10	1500	600	874	192,15
KRT15000750-10	1500	750	1060	208,74
KRT18200450-10	1820	450	841	201,30
KRT18200500-10	1820	500	921	208,01
KRT18200600-10	1820	600	1078	221,55
KRT18200750-10	1820	750	1307	242,41

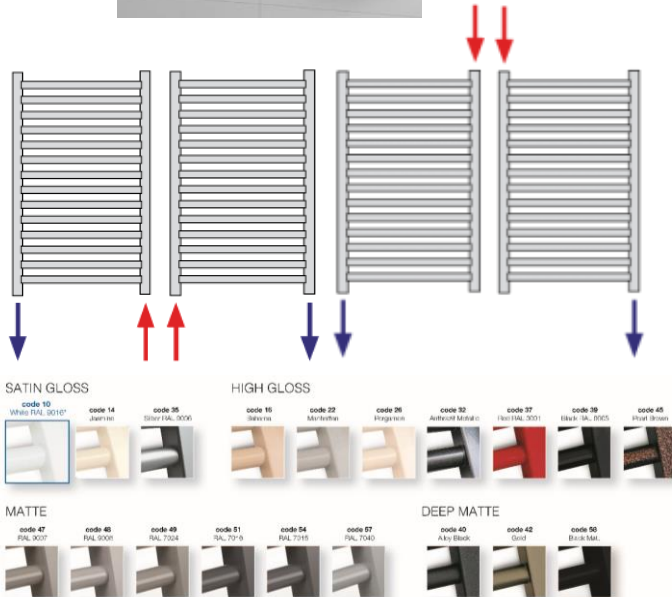

BARVNA LESTVICA: Standardna površinska barva radiatorjev je bela RAL 9016. Doplacilo 20% za drugo barvo s KORADO barvne lestvice (glej www.korado.si). Doplacilo 40% za drugo barvo z RAL lestvice.

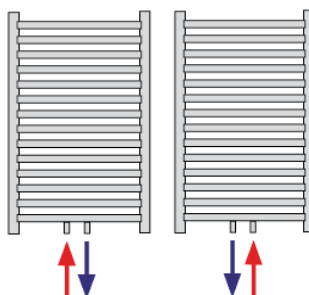

KORALUX RONDO COMFORT- M

Koda	Višina (h)	Širina (mm)	Moč (W)	Cena
KRT07000450M10	700	450	287	149,08
KRT07000500M10	700	500	315	150,79
KRT07000600M10	700	600	370	154,57
KRT07000750M10	700	750	450	160,43
KRT09000450M10	900	450	369	164,94
KRT09000500M10	900	500	405	167,51
KRT09000600M10	900	600	475	173,00
KRT09000750M10	900	750	579	181,66
KRT12200450M10	1220	450	504	190,08
KRT12200500M10	1220	500	553	194,47
KRT12200600M10	1220	600	650	202,89
KRT12200750M10	1220	750	791	215,45
KRT15000450M10	1500	450	626	212,28
KRT15000500M10	1500	500	687	217,53
KRT15000600M10	1500	600	808	228,26
KRT15000750M10	1500	750	984	244,98
KRT18200450M10	1820	450	772	237,29
KRT18200500M10	1820	500	848	244,12
KRT18200600M10	1820	600	996	257,79
KRT18200750M10	1820	750	1213	278,53

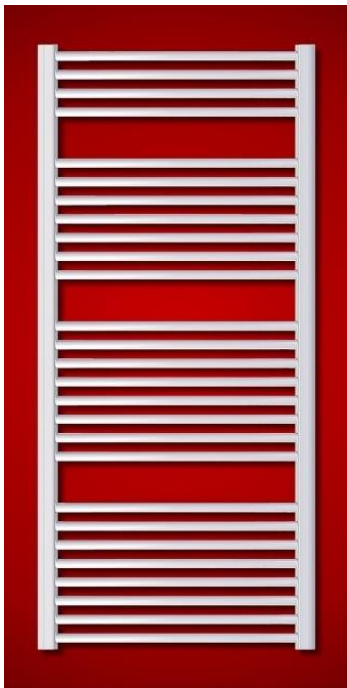

KOPALNIŠKI RADIATORJI LINEAR P.THERMAL

Koda	Višina (mm)	Širina (mm)	Moč (W)	Cena
9242	940	500	733	100,41
9244	940	600	948	107,12
9246	940	750	1157	118,46
9254	1220	500	1086	120,54
9256	1220	600	1409	129,20
9258	1220	750	1729	139,93
9266	1500	500	1086	141,64
9268	1500	600	1409	145,67
9270	1500	750	1729	160,80
9278	1820	500	1086	157,62
9280	1820	600	1409	170,92
9282	1820	750	1728	192,88



KOPALNIŠKI RADIATORJI RONDO P.THERMAL

Koda	Višina (mm)	Širina (mm)	Moč (W)	Cena
9243	940	500	538	101,87
9245	940	600	704	110,41
9247	940	750	896	121,76
9255	1220	500	699	125,42
9257	1220	600	824	134,44
9259	1220	750	1011	145,55
9267	1500	500	869	147,38
9269	1500	600	1025	151,40
9271	1500	750	1256	167,26
9279	1820	500	1078	164,09
9281	1820	600	1274	178,61
9283	1820	750	1567	198,74

TERMOSTATSKI VENTIL M (sredinski priklp) RAVNI

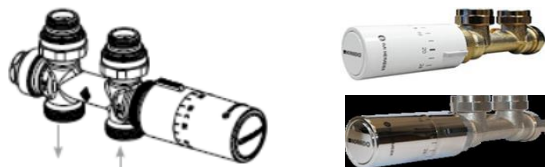

Koda	EAN		Cena
Z-D040	8592651664530	beli	175,77
Z-D041		krom	211,87

TERMOSTATSKI VENTIL M (sredinski priklp) KOTNI

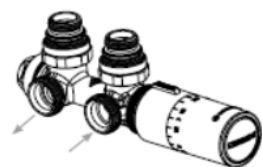

Koda	EAN		Cena
Z-D042	8592651664578	beli	175,77
Z-D043		krom	211,87

POKROV ZA TERMOSTATSKI VENTIL M



Koda	EAN	Naziv	Cena
Z-D027	8590822372222	Pokrov bel	8,91
Z-D028	8590822372239	Pokrov krom	25,46

T-KOS za glavo radiatorja



Koda	EAN	Naziv	Cena
Z-SKV-0001	8590822992147	T-kos	9,71

REGULATOR TEMPERATURE RE10A



Koda	EAN	Cena
Z-SKV-0004	8590822831484	66,50

VTIČ ZA EL. GRELEC z ročnim stikalom



Koda	EAN	Cena
Z-SKV-0002	8590822992154	8,92

ELEKTRIČNI GRELEC ZA RADIATORJE oglati bel



Koda	Naziv	Cena
GL01.300WH	Električni grelec 300W - 1/2"- bel	73,20
GL01.600WH	Električni grelec 600W - 1/2"- bel	75,64
GL01.900WH	Električni grelec 900W - 1/2"- bel	78,08

ELEKTRIČNI GRELEC ZA RADIATORJE oglati črn



Koda	Naziv	Cena
GL01.300BK	Električni grelec 300W - 1/2"- črn	76,86
GL01.600BK	Električni grelec 600W - 1/2"- črn	79,30
GL01.900BK	Električni grelec 900W - 1/2"- črn	81,74

ELEKTRIČNI GRELEC ZA RADIATORJE oglati krom



Koda	Naziv	Cena
GL01.300CH	Električni grelec 300W - 1/2"- krom	76,86
GL01.600CH	Električni grelec 600W - 1/2"- krom	76,86
GL01.900CH	Električni grelec 900W - 1/2"- krom	78,08

ELEKTRIČNI GRELEC ZA RADIATORJE okrogli bel



Koda	Naziv	Cena
GL02.300WH	Električni grelec 300W - 1/2"- bel	73,20
GL02.600WH	Električni grelec 600W - 1/2"- bel	75,64
GL02.900WH	Električni grelec 900W - 1/2"- bel	78,08

RADIATORSKE KONZOLE C stenska montaža

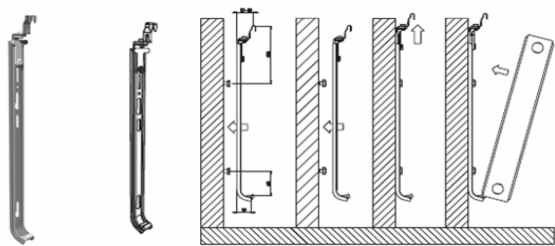

Koda	Koda P.	EAN	Dimenzije (mm)	Pakiranje	Cena
C-300	1501	3830016901513	300	2 kosa	7,93
C-400	1502		400	2 kosa	8,05
C-500	1503		500	2 kosa	8,30
C-600	1500	3830016901506	600	2 kosa	8,60
C-700	1505		700	2 kosa	9,15
C-900	1504	3830016901544	900	2 kosa	9,33

Konzola za vse tipe radiatorjev brez ušesc, konzola drži zgornji in spodnji rob radiatorja preko rešetke. V kompletu 2x konzola, 2x sidni vložek Ø10, 2x vijak M8 x 70.

RADIATORSKE KONZOLE H stenska montaža

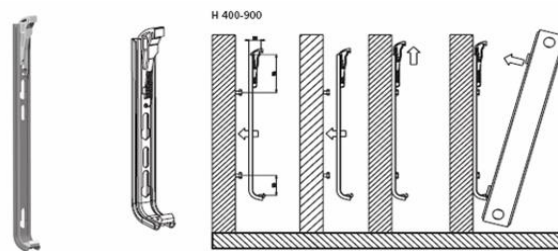

Koda	Koda P.	EAN	Dimenzije (mm)	Pakiranje	Cena
H-300ko	1010		300	2 kosa	7,50
H-400ko	1011		400	2 kosa	7,63
H-500ko	1012	3830016900264	500	2 kosa	7,75
H-600ko	1013		600	2 kosa	7,99
H-900ko	1014	3830016900288	900	2 kosa	8,72

Konzola za vse tipe radiatorjev z ušesci, plastično držalo se ob pritisku radiatorja samodejno zaskoči, v kompletu 2x konzola, 2x sidni vložek Ø10 in 2x vijak M8 x 70.

RADIATORSKE KONZOLE TH talna montaža

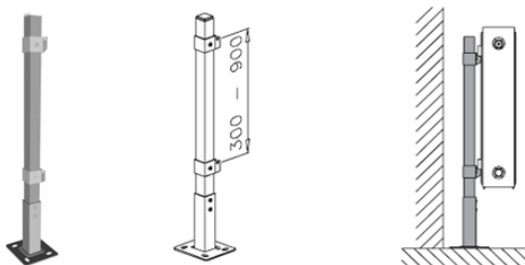

Koda	Koda P.	EAN	Pakiranje	Cena / kos
TH-300	1123		1	16,29
TH-500	1124		1	17,14
TH-600	1125		1	18,18
TH-900	1126		1	20,62

Konzola za talno montažo za vse tipe in znamke radiatorjev, ki imajo na zadnji strani privarjena ušesa. V kompletu: 1x konzola, 2x sidni vložek, 2x vijak M8x60.

RADIATORSKE KONZOLE T talna montaža

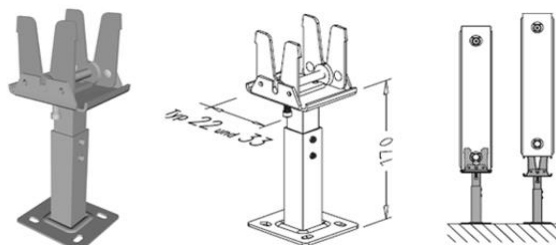

Koda	Koda P.	EAN	Pakiranje	Cena / kos
T-2	1121	3830016911215	1 kos	23,85

Konzola za talno montažo za tip 22 in 33. V kompletu 4x sidni vložek, 4x vijak M8x60

OBEŠALA ZA BRISAČE

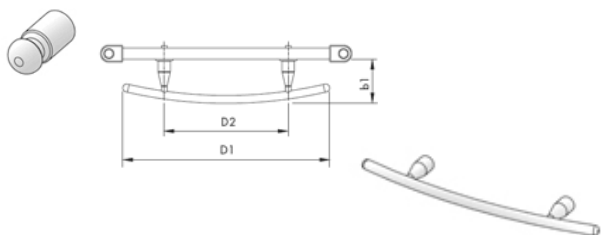

Koda	EAN		Cena
Z-D035	8590822837363	Koratherm - 370mm	106,15
Z-D036	8590822837370	Koratherm - 518mm	113,35
Z-D038	8590822837394	Koratherm - kljukica	26,74

Za vse modele KORALUX razen STANDARD.

ROZETA PVC ENOJNA



Koda	EAN	Ø(mm)		Cena
384006015	8595609115283	D15	bela	0,415
384006018	8595609115306	D18	bela	0,415
384006022	8595609115320	D22	bela	0,336
384006215	8595609115368	D15	krom	1,086
384006218	8595609115382	D18	krom	1,122
384006222	8595609115405	D22	krom	1,501
384006228	8595609115429	D23	krom	1,501



RADIATORSKI HOLANDEC RAVNI

Koda	EAN	Cena
92160400160	4260175473139	6,94

Radiatorski holandec ravni črni 1/2"

92160410160	4260175474808	6,94
--------------------	---------------	-------------

Radiatorski holandec ravni črni 3/8"



RADIATORSKI HOLANDEC KOTNI

Koda	EAN	Cena
92160400159	4260175473122	6,94

Radiatorski holandec kotni črni 1/2"

92160410159	4260175473146	6,94
--------------------	---------------	-------------

Radiatorski holandec kotni črni 3/8"



RADIATORSKI HOLANDEC RAVNI

Koda	EAN	Cena
92160408160	4260477953186	7,16

CU radiatorski holandec ravni 1/2"



RADIATORSKI HOLANDEC KOTNI

Koda	EAN	Cena
92160408159	4260477953179	7,16

CU radiatorski holandec kotni 1/2"



TERMOSTATSKI VENTIL RAVNI

Koda	EAN	Cena
90481500521	4260175470473	11,22

Termostatski radiatorski ventil ravni črni 1/2"

90481000521	4260175470466	10,65
--------------------	---------------	--------------

Termostatski radiatorski ventil ravni črni 3/8"



TERMOSTATSKI VENTIL KOTNI

Koda	EAN	Cena
90481570521	4260175470442	11,22

Termostatski radiatorski ventil kotni črni 1/2"

90481070521	4260175470435	10,65
--------------------	---------------	--------------

Termostatski radiatorski ventil kotni črni 3/8"



TERMOSTATSKI VENTIL RAVNI

Koda	EAN	Cena
90481500522	4260175473764	10,27

CU radiatorski termostatski ventil ravni 1/2"



TERMOSTATSKI VENTIL KOTNI

Koda	EAN	Cena
90481570522	4260175473757	10,27

CU radiatorski termostatski ventil kotni 1/2"



RADIATORSKI ADAPTER

Koda	EAN	Cena
82811500002	4260175470794	1,06

Radiatorski adapter



ODZRAČEVALNIK

Koda	EAN	Cena
91170400164	4260477955678	7,43

Ročni odzračevalnik za razdelilec



ODZRAČEVALNI LONČEK

Koda	EAN	Cena
40101500002	4260477955241	10,81

Avtomatski odzračevalni lonček



EUROKONUS

Koda	EAN	Cena
82501602208	4260175470824	1,92

Eurokonus 16 x 2 ALUM/PEX



TERMOSTATSKA GLAVA

Koda	EAN	Cena
93911100000	4260477955609	11,16

Termostatska glava

RAZDELILCI za talno ogrevanje



Krogelni ventil se dobavi posebej.

Koda	EAN	Naziv	Cena
70200200201	4260175479711	Razdelilec 2 veji	100,92
70200300201	4260477955586	Razdelilec 3 veje	124,14
70200400201	4260477955593	Razdelilec 4 veje	157,48
70200500201	4260477955609	Razdelilec 5 vej	181,29
70200600201	4260477955616	Razdelilec 6 vej	205,40
70200700201	4260477955623	Razdelilec 7 vej	227,42
70200800201	4260477955630	Razdelilec 8 vej	248,86
70200900201	4260477955647	Razdelilec 9 vej	270,29
70200100201	4260477955654	Razdelilec 10 vej	291,73
702001100201	4260477955661	Razdelilec 11 vej	312,56
702001200201	4260175478219	Razdelilec 12 vej	342,93

RAZDELILCI PLASTIČNI za talno ogrevanje



Koda	EAN	Naziv	Cena
MLK00002010		Razdelilec MULTIKAL plastični 2 veji	148,22
MLK00003010		Razdelilec MULTIKAL plastični 3 veje	177,75
MLK00004010		Razdelilec MULTIKAL plastični 4 veje	203,41
MLK00005010		Razdelilec MULTIKAL plastični 5 vej	235,09
MLK00006010		Razdelilec MULTIKAL plastični 6 vej	261,76
MLK00007010		Razdelilec MULTIKAL plastični 7 vej	298,17
MLK00008010		Razdelilec MULTIKAL plastični 8 vej	324,83
MLK00009010		Razdelilec MULTIKAL plastični 9 vej	347,19
MLK00010010		Razdelilec MULTIKAL plastični 10 vej	369,84
MLK00011010		Razdelilec MULTIKAL plastični 11 vej	401,95
MLK00012010		Razdelilec MULTIKAL plastični 12 vej	435,78



MANOMETER

Koda	EAN	Cena
ACC00000352		22,57

Manometer za tlačni test razdelilca



MAGNETNI FILTER

Koda	EAN	Cena
DEF00000003		103,58

Magnetni filter 1" z ventilom



TERMOSTATSKI VENTIL

Koda	EAN	Cena
90612525005	4260477953643	31,35

Ventil za razdelilec s termometrom ravni rdeč 1"



TERMOSTATSKI VENTIL

Koda	EAN	Cena
90612525002	4260175472552	31,35

Ventil za razdelilec s termometrom ravni moder 1"



VENTIL ZA RAZDELILEC

Koda	EAN	Cena
90612525008	4260175478417	20,13

Ventil za razdelilec ravni rdeč 1"



VENTIL ZA RAZDELILEC

Koda	EAN	Cena
90612525009	4260175478400	20,13

Ventil za razdelilec ravni moder 1"



VENTIL ZA RAZDELILEC

Koda	EAN	Cena
90612525001	4260175478431	22,81

Ventil za razdelilec kotni rdeč 1"



VENTIL ZA RAZDELILEC

Koda	EAN	Cena
90612525003	4260175478424	22,81

Ventil za razdelilec kotni moder 1"



EUROKONUS

Koda	EAN	Cena
82501602208	4260175470824	1,92

Eurokonus 16 x 2 ALUM/PEX

RAZDELILNE OMARICE PODOMETNE z zapahom za talno ogrevanje



NOVO

Koda	Naziv	Cena
ECO-MW0335Z	Omarica razdelilna podometna ECO-0 / 2 veji, nastavljiva	50,51
ECO-MW0435Z	Omarica razdelilna podometna ECO-1 / 2-4 veje, nastavljiva	62,50
ECO-MW0565Z	Omarica razdelilna podometna ECO-2 / 5-8 vej, nastavljiva	67,88
ECO-MW0715Z	Omarica razdelilna podometna ECO-3 / 8-10 vej, nastavljiva	75,16
ECO-MW0795Z	Omarica razdelilna podometna ECO-4 / 10-12 vej, nastavljiva	82,01
ECO-MW0965Z	Omarica razdelilna podometna ECO-5 / 12-14 vej, nastavljiva	100,08
ECO-MW1140Z	Omarica razdelilna podometna ECO-6 / 14-16 vej, nastavljiva	114,18

ECO-ADAPT0400Z	Omarica razdelilna podometna ADAPT-1 / 2-4 veje, premična stranica	73,63
ECO-ADAPT0600Z	Omarica razdelilna podometna ADAPT-2 / 5-8 vej, premična stranica	86,99
ECO-ADAPT0800Z	Omarica razdelilna podometna ADAPT-3 / 8-10 vej, premična stranica	102,97
ECO-ADAPT1000Z	Omarica razdelilna podometna ADAPT-4 / 10-12 vej, premična stranica	129,63
ECO-ADAPT1200Z	Omarica razdelilna podometna ADAPT-5 / 12-14 vej, premična stranica	152,56

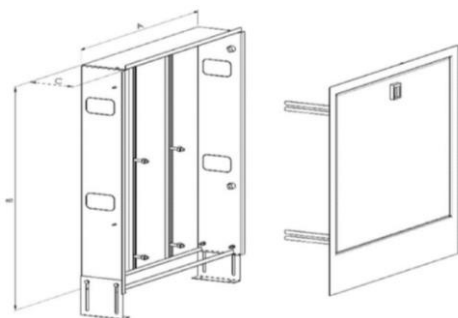

A	B	C	Dimenzije z embalažo (mm)	Neto teža (kg)
335	575 - 665	110 - 170	390 / 605 / 115	5,120
435	575 - 665	110 - 170	490 / 605 / 115	5,600
565	575 - 665	110 - 170	620 / 605 / 115	6,325
715	575 - 665	110 - 170	770 / 605 / 115	7,800
795	575 - 665	110 - 170	850 / 605 / 115	8,540
965	575 - 665	110 - 170	1020 / 605 / 115	10,000

CEVI za talno ogrevanje



Koda	Naziv	V kolutu (m)	Cena / m
MULTIC.16-R200	IST cev alumplast 16 x 2	200	1,31
MULTIC.16-R450	IST cev alumplast 16 x 2	450	1,31

PLOŠČE za talno ogrevanje



Koda	Naziv	Dimenzije (cm)	Cena / m ²
2592016	Plošča za talno ogrevanje 3,5cm	138 x 69 x 3,5	12,44
2592017	Plošča za talno ogrevanje 4,5cm	138 x 69 x 4,5	16,84
2592018	Plošča za talno ogrevanje 5cm	138 x 69 x 5,5	19,28
2592020	Plošča za talno ogrevanje brez izolacije	138 x 69 x 3,7	10,00

OBJEMKE ZA FIKSIRANJE DOVODNIH CEVI za talno ogrevanje



Koda	Naziv		Cena
384182595	Objemka za fiksiranje dovodnih cevi N1 x 25 - 8/75	enojna	0,32
384183295	Objemka za fiksiranje dovodnih cevi N1 x 32 - 8/75	enojna	0,37
384283295	Objemka za fiksiranje dovodnih cevi N2 x 32 - 8/75	dvojna	0,60

SKOBE za talno ogrevanje



Koda	Naziv	Pakirano kos	kos	Cena
390000305	Skoba za talno ogrevanje tip C ročna	50	1	0,23
390000307	Skoba za talno ogrevanje tip D za tacker	200	1	0,22
390000310	Tacker - pritrđilec za skobe			296,75



TOPLOVODNI KALORIFER VOLCANO VR MINI

Koda	Naziv		Pretok zraka (m ³ /h)	Cena
1-4-0101-0455	VOLCANO VR MINI EC	Konzole v ceni. Dimenzije: 530x530mm, globina 300mm (s konzolo 517mm)	2100	390,40
1-4-0101-0445	VOLCANO VR MINI AC	Konzole v ceni. Dimenzije: 530x530mm, globina 310mm (s konzolo 517mm)	2100	362,34
1-4-0101-0624	VOLCANO VR MINI 3 EC	Konzole v ceni. Dimenzije: 530x530mm, globina 300mm (s konzolo 517mm)	2000	488,00
1-4-0101-0498	VOLCANO VR-D MINI EC DESTRATIFIKATOR	Konzole v ceni. Dimenzije: 530x530mm, globina 300mm (s konzolo 517mm)	2330	337,94

TOPLOVODNI KALORIFER VOLCANO VR1

Koda	Naziv		Pretok zraka (m ³ /h)	Cena
1-4-0101-0442	VOLCANO VR1 EC	Konzole v ceni. Dimenzije: 700x700mm, globina 350mm (s konzolo 610mm)	5300	567,30
1-4-0101-0446	VOLCANO VR1 AC	Konzole v ceni. Dimenzije: 700x700mm, globina 355mm (s konzolo 610mm)	5300	523,38

TOPLOVODNI KALORIFER VOLCANO VR2

Koda	Naziv		Pretok zraka (m ³ /h)	Cena
1-4-0101-0443	VOLCANO VR2 EC	Konzole v ceni. Dimenzije: 700x700mm, globina 350mm (s konzolo 610mm)	4850	624,64
1-4-0101-0444	VOLCANO VR2 AC	Konzole v ceni. Dimenzije: 700x700mm, globina 355mm (s konzolo 610mm)	4850	575,84

TOPLOVODNI KALORIFER VOLCANO VR3

Koda	Naziv		Pretok zraka (m ³ /h)	Cena
1-4-0101-0444	VOLCANO VR3 EC	Konzole v ceni. Dimenzije: 700x700mm, globina 350mm (s konzolo 610mm)	5700	705,16
1-4-0101-0445	VOLCANO VR3 AC	Konzole v ceni. Dimenzije: 700x700mm, globina 355mm (s konzolo 610mm)	5700	650,26

TOPLOVODNI KALORIFER VOLCANO VR4

Koda	Naziv		Pretok zraka (m ³ /h)	Cena
1-4-0101-0626	VOLCANO VR4 EC	Konzole v ceni. Dimenzije: 700x700mm, globina 350mm (s konzolo 610 mm)	5300	882,06

TOPLOVODNI KALORIFER VOLCANO VR-D destratifikator

Koda	Naziv		Pretok zraka (m ³ /h)	Cena
1-4-0101-0440	VOLCANO VR-D EC	Konzole v ceni. Dimenzije: 700x700mm, globina 350mm (s konzolo 610 mm)	6500	502,64
1-4-0101-0449	VOLCANO VR-D AC	Konzole v ceni. Dimenzije: 700x700mm, globina 355mm (s konzolo 610 mm)	6500	469,70

TEHNIČNI PODATKI		VR Mini AC/EC	VR Mini 3 AC/EC	VR-D Mini AC/EC	VR1 AC/EC	VR2 AC/EC	VR3 AC/EC	VR4 AC/EC	VR-D AC/EC
Razpon ogrevalne moči	kW	3-20	2-27	-	5-30	8-50	13-75	10-90	-
Maksimalni pretok zraka	m ³ /h	2100	2000	2330	5300	4850	5700	5300	6500
Horizontalni doseg (maks.)	m	14	14	16	23	22	25	23	28
Vertikalni doseg (maks.)	m	8	8	10	12	11	12	12	15
El. moč AC motorja	W	115	115	115	280	280	410	320	410
El. moč EC motorja	W	95	95	95	250	250	370	285	370
Poraba el. energije	W	91	91	-	202	226	355	123	-
Raven hrupa AC motorja	dB	52	52	49	56	56	57	56	58
Raven hrupa EC motorja	dB	50	50	50	54	54	55	54	56

Število priključenih kaloriferjev na model regulacije

Koda	Naziv	VR Mini AC/EC	VR Mini 3 AC/EC	VR-D Mini AC/EC	VR1 AC/EC	VR2 AC/EC	VR3 AC/EC	VR4 AC/EC	VR-D AC/EC
1-4-0101-0438	Regulacija WING / VOLCANO (ACmotor)	4	4	1	2	2	1	1	1
1-4-0101-0434	Regulator hitrosti ARW 3,0/2	4	4	1	1	1	1	1	1
1-4-0101-0038	Regulacija WING / VOLCANO (AC motor)	1	1	1	1	1	1	1	1
1-4-0101-0167	Regulator hitrosti ARW 0,6/1	1	1	0	0	0	0	0	0
1-4-0101-0453	Potenciometer VR EC (0-10V)	8	8	8	8	8	8	8	8
1-4-0101-0473	Potenciometer s termostatom 0-10V	8	8	8	8	8	8	8	8
1-4-0101-0457	Regulator Volcano HMI (0-10V) EC	8	8	8	8	8	8	8	8

OPREMA ZA TOPLOVODNE KALORIFERJE VOLCANO

Koda	Naziv	Cena
1-4-0101-0158	Regulator Volcano HMI Wi-fi (0 - 10V) za EC motorje	129,32
1-4-0101-0457	Regulator Volcano HMI (0 - 10V) za EC motorje	95,16

Koda	Naziv	Cena
1-4-0101-0438	Regulacija WING / VOLCANO (za AC motorje)	29,28
Dovoljena obremenitev: 1A za 230VAC0, 02A za 0-10V. Temperaturno območje: 10...30°C. Razred zaščite: IP30		

1-4-0101-0434	Regulator hitrosti ARW 3,0/2 (IP54)	95,16
1-4-0101-0167	Regulator hitrosti ARW 0,6/1 (IP54)	51,24
Avtoregulator, ročno upravljanje, prilagajanje hitrosti 5 stopenj.		

Koda	Naziv	Cena
1-4-0101-0038	Termostat VR (IP30)	17,08
Ločeni kontrolni izhodi za ogrevanje (Volcano konvektorji) in funkcijo hlajenja (Volcano VR-D konvektorji)		

Koda	Naziv	Cena
1-4-0101-0453	Potenciometer VR EC (0-10V)	34,16
1-4-0101-0473	Potenciometer VR EC (0-10V) s termostatom	43,92

Koda	Naziv	Cena
1-2-1205-0007	Sobni senzor NTC za HMI 0457 regulacijo	29,28
1-2-1205-0008	Sobni senzor NTC	21,96

Koda	Naziv	Cena
1-2-0393-1978	Nadometna doza za HMI (kovinska)	13,66

Koda	Naziv	Cena
1-2-1204-2019	Ventil z motornim pogonom VA-VEH202TA	75,64

Koda	Naziv	Cena
1-2-2702-0076	Priključne cevi 3/4" - (d=0,6 / 0,9m)	28,06

Koda	Naziv	Cena
1-5-2701-4021	Lovilec kondenza za VR Mini-VR Mini3	28,06
1-5-2701-4019	Lovilec kondenza za VR1 - VR4	49,17



VODNA ZRAČNA ZAVESA WING II W za ogrevanje



Z AC motorjem

Koda	Naziv	Dolžina (cm)	Pretok (m³/h)	Cena
1-4-2801-0250	WING II W100 (AC)	100	bela 1850	623,42
1-4-2801-0251	WING II W150 (AC)	150	bela 3100	736,88
1-4-2801-0252	WING II W250 (AC)	200	bela 4400	916,22

Z EC motorjem

Koda	Naziv	Dolžina (cm)	Pretok (m³/h)	Cena
1-4-2801-0259	WING II W100 (EC)	100	bela 1850	689,30
1-4-2801-0260	WING II W150 (EC)	150	bela 3100	854,00
1-4-2801-0261	WING II W200 (EC)	200	bela 4400	1.054,08
1-4-2801-0308	WING II W100 (EC)	100	siva 1850	689,30
1-4-2801-0309	WING II W150 (EC)	150	siva 3100	854,00
1-4-2801-0310	WING II W200 (EC)	200	siva 4400	1.054,08

ELEKTRO ZRAČNA ZAVESA WING II E za ogrevanje



Z AC motorjem

Koda	Naziv	Dolžina (cm)	Pretok (m³/h)	Cena
1-4-2801-0253	WING II E100 (AC)	100	bela 1850	620,98
1-4-2801-0254	WING II E150 (AC)	150	bela 3150	732,00
1-4-2801-0255	WING II E200 (AC)	200	bela 4500	912,56

Z EC motorjem

Koda	Naziv	Dolžina (cm)	Pretok (m³/h)	Cena
1-4-2801-0262	WING II E100 (EC)	100	bela 1850	685,64
1-4-2801-0263	WING II E150 (EC)	150	bela 3150	850,34
1-4-2801-0264	WING II E200 (EC)	200	bela 4500	1.051,64
1-4-2801-0311	WING II E100 (EC)	100	siva 1850	685,64
1-4-2801-0312	WING II E150 (EC)	150	siva 3150	850,34
1-4-2801-0313	WING II E200 (EC)	200	siva 4500	1.051,64

HLADILNA ZRAČNA ZAVESA WING II C za hlajenje



Z AC motorjem

Koda	Naziv	Dolžina (cm)	Pretok (m³/h)	Cena
1-4-2801-0256	WING II C100 (AC)	100	bela 1950	522,16
1-4-2801-0257	WING II C150 (AC)	150	bela 3200	639,28
1-4-2801-0258	WING II C200 (AC)	200	bela 4600	823,50

Z EC motorjem

Koda	Naziv	Dolžina (cm)	Pretok (m³/h)	Cena
1-4-2801-0265	WING II C100 (EC)	100	bela 1950	570,96
1-4-2801-0266	WING II C150 (EC)	150	bela 3200	744,20
1-4-2801-0267	WING II C200 (EC)	200	bela 4600	906,46
1-4-2801-0314	WING II C100 (EC)	100	siva 1950	570,96
1-4-2801-0315	WING II C150 (EC)	150	siva 3200	744,20
1-4-2801-0316	WING II C200 (EC)	200	siva 4600	906,46

INDUSTRIJSKA ZRAČNA ZAVESA WING PRO



HLADILNA ZRAČNA ZAVESA

Koda	Naziv	Pretok (m³/h)	Cena
1-4-2801-0347	WING PRO C150 (EC)	8500	1.122,40
1-4-2801-0353	WING PRO C200 (EC)	12800	1.483,52

VODNA ZRAČNA ZAVESA Z ENIM TOPLOTNIM IZMENJEVALCEM

Koda	Naziv	Pretok (m³/h)	Cena
1-4-2801-0348	WING PRO W150 R1 (EC) - 1 topl.izm.	7900	1.338,34
1-4-2801-0354	WING PRO W200 R1 (EC) - 1 topl.izm.	11900	1.737,28

VODNA ZRAČNA ZAVESA Z DVEMA TOPLOTNIMA IZMENJEVALCEMA

Koda	Naziv	Pretok (m³/h)	Cena
1-4-2801-0349	WING PRO W150 R2 (EC) - 2 topl. izm.	7300	1.411,54
1-4-2801-0355	WING PRO W200 R2 (EC) - 2 topl. izm.	10700	1.847,08

OPREMA ZA ZRAČNE ZAVESE



KONZOLE ZA ZRAČNE ZAVESE

Koda	Naziv	Cena
1-4-2801-0053	Konzole za WING 100	24,40
1-4-2801-0054	Konzole za WING 150/200	32,94
1-4-2801-0180	Konzole za zračno zaveso WING II 100	24,40
1-4-2801-0181	Konzole za zračno zaveso WING II 150/200	36,60
1-4-2801-0317	Konzole za zračno zaveso WING II 100 (RAL 7016)	24,40
1-4-2801-0318	Konzole za zračno zaveso WING II 150/200 (RAL 7016)	36,60



REGULACIJA ZA ZRAČNE ZAVESE

Koda	Naziv	Cena
1-4-2801-0156	Regulacija HMI WING EC (0 - 10V) Wi-fi za EC motorje	129,32
1-4-2801-0155	Regulacija HMI WING EC (0-10V (za EC motorje)	111,02
1-4-0101-0438	Regulacija WING / VOLCANO (za AC motorje)	29,28

Dovoljena obremenitev: 1A za 230VAC0, 02A za 0-10V. Temperaturno območje: 5...40°C. Razred zaščite: IP20

Dovoljena obremenitev: 1A za 230VAC0, 02A za 0-10V. Temperaturno območje: 10...30°C. Razred zaščite: IP30



Koda	Naziv	Cena
1-4-0101-0454	Senzor vrat (magnet) REED WING EC	24,40

Switching current: 500mA. Switching voltage: max 200V. Connection: screw.



Koda	Naziv	Cena
1-2-1204-2019	Ventil z motornim pogonom VA-VEH202TA	75,64
1-2-2702-0076	Priključne cevi 3/4" - (d=0,6 / 0,9m)	28,06

Dolžina: 0,6 - 0,9m. Priključek: GW 3/4". Tlak max.:1,6 Mpa. Min. delovna temp. voda: 5°C. Min. delovna temp. (glikol): -20°C. Max. delovna temp.130°C. V setu: cev 2 x, tesnilo 4x.

TEHNIČNE LASTNOSTI WING II W		WING II W100 (AC)	WING II W100 (EC)	WING II W150 (AC)	WING II W150 (EC)	WING II W200 (AC)	WING II W200 (EC)
Koda	bela	1-4-2801-0250	1-4-2801-0259	1-4-2801-0251	1-4-2801-0260	1-4-2801-0252	1-4-2801-0261
	siva		1-4-2801-0308		1-4-2801-0309		1-4-2801-0310
Max. širina vrat na 1 zračno zaveso	m	1		1,5		2	
Max. višina vrat (vert.postavitev)	m	3,7					
Max. pretok zraka	m³/h	1850		3100		4400	
Ogrevalna moč	kW	4 - 17		10 - 32		17 - 47	
Max. temp. ogrevne vode	°C	95					
Max. delovni tlak	Mpa	1,6					
Volumen vode	dm³	1,6		2,6		3,6	
Število spiral topl.izmenjevalca	kos	2					
Premer cevnega priključka	"						
Napetost	V/pH/Hz	~230/1/50					
Moč električnega grelca	kW						
Nazivni tok električnega grelca	A						
Moč motorja	kW	0,235	0,2	0,375	0,3	0,58	0,47
Nazivni tok EC motorja	A	1,2	1,1	1,7	1,3	2,6	1,9
Teža	kg	20,8	21,2	27,8	24,5	34,6	30,4
Razred zaščite	IP	20					

TEHNIČNE LASTNOSTI WING II E		WING II E100 (AC)	WING II E100 (EC)	WING II E150 (AC)	WING II E150 (EC)	WING II E200 (AC)	WING II E200 (EC)
Koda	bela	1-4-2801-0253	1-4-2801-0262	1-4-2801-0254	1-4-2801-0263	1-4-2801-0255	1-4-2801-0264
	siva		1-4-2801-0311		1-4-2801-0312		1-4-2801-0313
Max. širina vrat na 1 zračno zaveso	m	1		1,5		2	
Max. višina vrat (vert.postavitev)	m	3,7					
Max. pretok zraka	m³/h	1850		3150		4500	
Ogrevalna moč	kW	2 ali 4/6		8/12		10/15	
Max. temp. ogrevne vode	°C						
Max. delovni tlak	Mpa						
Volumen vode	dm³						
Število spiral topl.izmenjevalca	kos						
Premer cevnega priključka	"						
Napetost	V/pH/Hz	~230/1/50 za 2kW, ~400/3/50 za 4/6kW		~400/3/50		~400/3/50	
Moč električnega grelca	kW	2 in 4		4 in 8		8 in 12	
Nazivni tok električnega grelca	A	6 / max.9		11,5 / max.17,3		14,5 / max.21,4	
Moč motorja	kW	0,235	0,2	0,375	0,3	0,58	0,47
Nazivni tok EC motorja	A	1,2	1,1	1,7	1,3	2,6	1,9
Teža	kg	20	17,3	26,8	23,4	33,3	29,1
Razred zaščite	IP	20					

TEHNIČNE LASTNOSTI WING II C		WING II C100 (AC)	WING II C100 (EC)	WING II C150 (AC)	WING II C150 (EC)	WING II C200 (AC)	WING II C200 (EC)
Koda	bela	1-4-2801-0256	1-4-2801-0265	1-4-2801-0257	1-4-2801-0266	1-4-2801-0258	1-4-2801-0267
	siva		1-4-2801-0314		1-4-2801-0315		1-4-2801-0316
Max. širina vrat na 1 zračno zaveso	m	1		1,5		2	
Max. višina vrat (vert.postavitev)	m	4					
Max. pretok zraka	m³/h	1950		3200		4600	
Ogrevalna moč	kW						
Max. temp. ogrevne vode	°C						
Max. delovni tlak	Mpa						
Volumen vode	dm³						
Število spiral topl.izmenjevalca	kos						
Premer cevnega priključka	"						
Napetost	V/pH/Hz	~230/1/50					
Moč električnega grelca	kW						
Moč motorja	kW	0,235	0,2	0,375	0,3	0,58	0,47
Nazivni tok EC motorja	A	1,2	1,1	1,7	1,3	2,6	1,9
Teža	kg	17,9	15,3	23,8	20,4	29,3	25,1
Razred zaščite	IP	20					

TEHNIČNE LASTNOSTI WING PRO		WING PRO W150 R2 (EC)	WING PRO W200 R2 (EC)	WING PRO W150 R1 (EC)	WING PRO W200 R1 (EC)	WING PRO C150 (EC)	WING PRO C200 (EC)
Koda	bela	1-4-2801-0349	1-4-2801-0355	1-4-2801-0348	1-4-2801-0354	1-4-2801-0347	1-4-2801-0353
Max. višina vrat	m	1,5	2	1,5	2	1,5	2
Doseg zračnega toka	m	7		7,5		8	
Max. pretok zraka	m³/h	7300	10700	7900	11900	8500	12800
Ogrevalna moč	kW	17-58	28-88	3-32	15-48		
Max. temp. ogrevne vode	°C	130					
Max. delovni tlak	Mpa	1,6					
Premer cevnega priključka	"	3/4"					
Napetost	V/pH/Hz	~230/1/50					
Moč EC motorja	kW	2 x 0,25	3 x 0,25	2 x 0,25	3 x 0,25	2 x 0,25	3 x 0,25
Nazivni tok EC motorja	A	2 x 1,3	3 x 1,3	2 x 1,3	3 x 1,3	2 x 1,3	3 x 1,3
Teža (brez vode)	kg	53,6	69,6	50,5	66,1	43,4	58,3
Razred zaščite	IP	54					
Dimenzije	mm	1556 x 536 x 530	2072 x 536 x 530	1556 x 536 x 530	2072 x 536 x 530	1556 x 536 x 530	2072 x 536 x 530

LOKALNA REKUPERACIJA

LOKALNI REKUPERATOR z daljinskim upravljalnikom

Koda	EAN	Naziv	Pretok	Cena
004388	8058647113852	Quantum NEXT 100	25/21/17/14/10 m³/h	425,78
003015	8058647113494	Quantum NEXT 150	60/50/40/30/20 m³/h	431,88

Dodatne opcije:	Naziv	Cena
000971*	8058647114125 Zunanja rešetka TRM 100 PRO	63,44
000972	8058647114132 Zunanja rešetka TRM 150 PRO	68,32
005095	Zunanja protihrupna rešetka TRM 150 ISO	80,52
004635	Teleskopska cev ø100 dolž.300/570mm	10,49
000456	Teleskopska cev ø150 dolž.300/570mm	13,54

Quantum NEXT je samostojna decentralizirana prezračevalna rekuperacijska naprava, namenjena zagotavljanju zadostnega prezračevanja zaprtih prostorov z minimalno izgubo toplotne energije. Priporočljiva je vgradnja dveh naprav, povezanih v par; ena enota dovaja svež zrak, druga enota odvaja obstoječi zrak iz prostora in obratno. Par enot se lahko namesti v en prostor ali v različne prostore (kot dnevna soba in spalnica). S tem dosežemo večje kroženje zraka oz. prezračeno stanovanjska ali poslovna prostora. Enota je namenjena za vgradnjo na zunanjo steno. Daljinski upravljalnik ima funkcije: način pretoka zraka (izmenični, vpih, izpih), način brez hlajenja, 5 stopenj stalne hitrosti, povečanje hitrosti, OFF-izklop, ponastavitev filtrov.



000971



005095



000456

LOKALNI REKUPERATOR s 3-stopenjskim stikalom

Koda	EAN	Naziv	Pretok	Cena
000468	8058647113869	Quantum HR 100	25/15/10 m³/h	248,88
000470	8058647113876	Quantum HR 150	60/40/20 m³/h	280,60

V ceni je zajeto:

000596	8058647114781	3-stopenjsko podometno stikalo CTRL-S	v ceni
000597	8058647114774	3-stopenjsko nadometno stikalo CTRL-S	v ceni

Dodatne opcije:

PTM00001	8058647113982	Stikalo s timerjem	82,59
003688	8058647113944	Stikalo s senzorjem za regulacijo vlage SEN-HY	108,34
CCM00001		Stikalo s senzorjem CO2	353,80
003692	8058647113968	Stikalo s senzorjem prisotnosti SRL	141,15
001548	8058647114750	KT100HR zapora za lokalni rekuperator, ø100	5,61
001549	8058647114767	KT150HR zapora za lokalni rekuperator, ø150	5,61
000456		Teleskopska cev ø150 dolž.300/570mm črna	13,54

Quantum HR je samostojna decentralizirana prezračevalna rekuperacijska naprava za zagotavljanje zadostnega prezračevanja zaprtih prostorov z minimalno izgubo toplotne energije. Priporočljiva je vgradnja dveh povezanih naprav; ena enota dovaja svež zrak, druga enota odvaja obstoječi zrak iz prostora in obratno. Par enot se lahko namesti v en prostor ali v različne prostore. Enota je namenjena za vgradnjo na zunanjo steno.



PTM00001



003688



CCM00001



003692

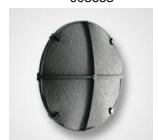

001548



000456

ENOSMERNNA DECENTRALIZIRANA MEHANSKA PREZRAČEVALNA ENOTA za neprekinjeno delovanje

Koda	*Odprodaja	EAN	Naziv	Cena
004635		8058647114002	Quantum MX 100HT, časovnik, senzor vlage	156,16
004664*		8058647113920	Quantum AX 150HT Timer, 2 hitrosti, senzor vlage	180,56
003686			Zunanja rešetka EG150, za Quantum AX in QR100	7,08

Naprava je idealna za uporabo v kopalnici, stranišču in majhnih do srednje velikih prostorih. Primerno za odsesavanje zraka neposredno na zunanjo stran ali s kratkimi vodi. Enota se lahko namesti na steno, strop ali okno. Enota je opremljena s senzorjem vlage na pokrovu (nastavljiv od 50% do 95% RH) in časovnikom (nastavljiv od ± 0' do 30'). Delovanje: kadar je odstotek relativne vlage višji od predhodno nastavljenih vrednosti, ventilator samodejno poveča hitrost. Ko se relativna vlaga spusti pod nastavljenostjo, ventilator ponovno preklopi v osnovno hitrost, z nastavljenim časovnikom zamikom. Največjo hitrost lahko aktivirate ročno preko stikala ali (opcijsko) z vlečno vrstico.



Podatkovni list : Evropska direktiva – ErP, Uredbe 1253/2014-1254/2014

LOKALNE REKUPERACIJSKE NAPRAVE

a) Blagovna znamka

AERAULIQA

b) Oznaka modela	QUANTUM NEXT 100	QUANTUM NEXT 150	QUANTUM HR 100	QUANTUM HR 150	QUANTUM AX 150 HT	QUANTUM MX 100
c) Razred SEC	A	A	A	A	C	C
c1) Razred SEC toplo podnebje kWh/m ²	-17	-18	-15,6	-16,2	-11,3	-10,8
c2) Razred SEC zmerno podnebje kWh/m ²	-40,6	-41,6	-37,5	-38,2	-25,5	-25,2
c3) Razred SEC hladno podnebje kWh/m ²	-81,8	-82,8	-75,6	-76,4	-50,6	-50,3
Energijska nalepka	Da	Da	Da	Da	Ne	Ne
d) Tip naprave	Stanovanjska - dvosmerna		Stanovanjska - dvosmerna		Stanovanjska - dvosmerna	
e) Vrsta pogona	Večstopenjski pogon		Večstopenjski pogon		Večstopenjski pogon	
f) Vrsta sistema za rekuperacijo toplote	Rekuperacija		Rekuperacija			
g) Toplotni izkoristek za rekuperacijo toplote %	74	74	74	74	N/A	N/A
h) Največja stopnja pretoka pri 100Pa m ³ /h	25	60	25	60	195	100
i) Vhodna el. moč pogona ventilatorja pri max. pretoku W	3,5	6	6	6	6,5	5
j) Nivo zvokovne moči dBA	39	40	35	38	56	43
k) Referenčna stopnja pretoka m ³ /h	18	41	17	41	195	72
l) Referenčna tlačna razlika Pa	10	10	10	10	10	10
m) Specifična vhodna moč W/m ³ /h	0,139	0,08	0,071	0,054	0,035	0,057
n1) Regulacijski faktor	0,65	0,65	1	1	0,65	0,65
n2) Vrsta regulacije	Lokalni nadzor		Ročno krmiljenje (ni DCV)		Lokalni nadzor	
o1) Deklarirana najvišja stopnja notranjega puščanja %	N/A	N/A	N/A	N/A	N/A	N/A
o2) Deklarirana najvišja stopnja zunanjega puščanja %	1	1	1	1	N/A	2
p1) Stopnja notranjega mešanja %	N/A	N/A	N/A	N/A	N/A	N/A
p2) Stopnja zunanjega mešanja %	N/A	N/A	N/A	N/A	N/A	N/A
q) Položaj in opis vidnega opozorila za filter	Rumena led		N/A	N/A	N/A	N/A
r) Navodila za namestitev regulirne rešetke	N/A	N/A	N/A	N/A	priložena navodila	
s) Internetni naslov z navodili za montažo						
t) Občutljivost pretoka zraka na spremembe tlaka %	N/A	N/A	N/A	N/A	N/A	N/A
u) Notranja / zunanja zračna tesnost m ³ /h	18	50	21	60	132	52
v1) Letna poraba električne energije - toplo podnebje AEC kWh	1	0,6	1	0,7	0,3	0,4
v2) Letna poraba električne energije - povprečno podnebje AEC kWh	1	0,6	1	0,7	0,3	0,4
v3) Letna poraba električne energije - hladno podnebje AEC kWh	1	0,6	1	0,7	0,3	0,4
w1) Prihranjeno letno ogrevanje - toplo podnebje AEC kWh	19,5	19,5	18	18,1	11,9	11,9
w2) Prihranjeno letno ogrevanje - povprečna klima AEC kWh	43,1	43,2	39,9	40	26,2	26,2
w3) Prihranjeno letno ogrevanje - hladno podnebje AEC kWh	84,3	84,3	78	78,2	51,3	51,3
Pretok zraka pri različnih hitrostih m ³ /h	25/21/17/14/10	60/50/40/30/20	25/15/10	60/40/20	max 187; min 29	max 90; min 15
Poraba energije pri različni hitrosti W	3,5 / 3 / 2,5 / 2 / 2	6 / 4,5 / 3,5 / 2,5 / 2	2,6/1,7/1,2	3,8/2,3/1,4	max 6,5; min 1,0	max 5; min 1,5
Glasnost pri 3m (1) pri različni hitrosti dB (A)	27/23/18/14/9	29/24/20/14/10	29/15/10	26/18/10	max 35; min < 9	max 32; min < 9
Toplotni izkoristek za rekuperacijo toplote %	70/72/74/78/82	70/72/74/78/82	70/74,3/82	70/74,3/82		
Temperatura prostora max. °C	-20°C ÷ +50°C	-20°C ÷ +50°C	-20°C ÷ +50°C	-20°C ÷ +50°C	50	40
Stopnja zaščite IP	X4	X4	X4	X4	X4	X4

Označevanje / Oznaka

220-240V ~ 50Hz



Type Approved
Seguridad
Regular Production
Surveillance
www.tuv.com
ID: 0217007721

Zmogljivost zraka, izmerjena po ISO 5801 a 230V 50Hz, gostota zraka 1,2 kg/m³.

Podatki so izmerjeni v priznanem laboratoriju TÜV Rheinland v Aerauliqua glede na Tehnični list IEC OD 2048 (level CTF1) za IEC 60335-1 in IEC 60335-2-80 Standard.

(1) Zvočna obremenitev pri 3m v prostem polju, prebji, pri 40% hitrosti, samo za primerjalne namene.

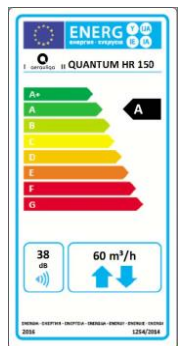
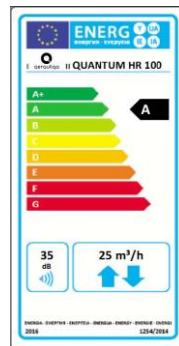
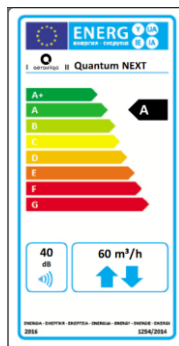

CENTRALNA REKUPERACIJA

REKUPERACIJSKE NAPRAVE QR z avtomatskim bypasom

Centralne prezračevalne naprave so namenjene za neprekinjen odvzem toplote (QR550A) vlažnega zraka, odvzetega iz vlažnih prostorov, in dogrevanje svežega zraka, ki je speljan v bivalne prostore. Enostaven sistem za vsak prostor zagotavlja pravilno prezračevanje - hitro črpanje povečane ravni vlage ali onesnaženega zraka. Predhodno ogrevanje / ohlajanje svežega zraka zmanjša potrebo po dodatnem ogrevanju oz. klimatizaciji. EC krtačni motorji bistveno zmanjšajo porabo električne energije. Pravilno vzdrževani filtri preprečujejo vstop cvetnega prahu v prostor.



Koda	EAN	Naziv	Cena
004922	8058647114903	QR120P centralna prezračevalna naprava 102m ³ /h SLIM LINE	1.266,36



Koda	EAN	Naziv	Cena
001266	8058647114422	QR180ABP centralna prezračevalna naprava 177m ³ /h z avtomatskim bypasom	1.893,44



Koda	EAN	Naziv	Cena
003217	8058647114439	QR280ABP centralna prezračevalna naprava 256m ³ /h z avtomatskim bypasom	2.002,02



Koda	EAN	Naziv	Cena
005292		QR340A centralna prezračevalna naprava 300m ³ /h z avtomatskim bypasom	2.083,76



Koda	EAN	Naziv	Cena
003696	8058647114453	QR400ABP centralna prezračevalna naprava 363m ³ /h z avtomatskim bypasom	2.677,90



Koda	EAN	Naziv	Cena
001016	8058647114484	QR550ABP centralna prezračevalna naprava 520m ³ /h z avtomatskim bypasom	2.793,80



Koda	EAN	Naziv	Cena
QREL1K		Elektrorelec 1 kW za predgretje	731,02

Podatkovni list : Evropska direktiva – ErP, Uredbe 1253/2014-1254/2014

CENTRALNE REKUPERACIJSKE NAPRAVE

a) Blagovna znamka

b) Oznaka modela

c) Razred SEC

c1) Razred SEC toplo podnebje

c2) Razred SEC zmerno podnebje

c3) Razred SEC hladno podnebje

Energijska nalepka

d) Tip naprave

e) Vrsta pogona

f) Vrsta sistema za rekuperacijo toplote

g) Toplotni izkoristek za rekuperacijo toplote

h) Največja stopnja pretoka pri 100Pa

i) Vhodna el. moč pogona ventilatorja pri max. pretoku

j) Nivo zvokovne moči

k) Referenčna stopnja pretoka

l) Referenčna tlačna razlika

m) Specifična vhodna moč

n1) Regulacijski faktor

n2) Vrsta regulacije

o1) Deklarirana najvišja stopnja notranjega puščanja

o2) Deklarirana najvišja stopnja zunanega puščanja

p1) Notranja hitrost mešanja

p2) Zunanja hitrost mešanja

q) Položaj in opis vidnega opozorila za filter

r) Navodila za namestitvev regulirne rešetke

s) Internetni naslov z navodili za montažo

t) Občutljivost pretoka zraka na spremembe tlaka

u) Notranja / zunanja zračna tesnost

v1) Letna poraba električne energije - toplo podnebje AEC

v2) Letna poraba električne energije - povprečno podnebje AEC

v3) Letna poraba električne energije - hladno podnebje AEC

w1) Prihranjeno letno ogrevanje - toplo podnebje AEC

w2) Prihranjeno letno ogrevanje - povprečna klima AEC

w3) Prihranjeno letno ogrevanje - hladno podnebje AEC

Glasnost pri 3m (1) pri različni hitrosti

Temperatura prostora max.

Stopnja zaščite IP

Označevanje / Oznaka

220-240V ~ 50Hz

Zmogljivost zraka, izmerjena po ISO 5801 a 230V 50Hz, gostota zraka 1,2 kg/m³.

Podatki so izmerjeni v priznanem laboratoriju TÜV Rheinland v Aerauligi glede na Tehnični list IEC OD 2048 (level CTF1) za IEC 60335-1 in IEC 60335-2-80 Standard.

(1) Zvočna obremenitev pri 3m v prostem polju, preboj, pri 40% hitrosti, samo za primerjalne namene

AERAULIQA

		QR120P			QR180A			QR280A		
		A	A	B	A	A	A	A	A	B
c1) Razred SEC toplo podnebje	kWh/m ²	-14,7	-11,3	-8,5	-15,0	-10,6	-6,7	-15,2	-11,0	-7,2
c2) Razred SEC zmerno podnebje	kWh/m ²	-39,5	-35,5	-31,8	-39,4	-34,3	-29,9	-39,3	-34,4	-30,1
c3) Razred SEC hladno podnebje	kWh/m ²	-82,8	-77,7	-67,8	-77,3	-71,1	-65,9	-76,8	-70,7	-65,5
Energijska nalepka		Da			Da			Da		
d) Tip naprave		Stanovanjska - dvosmerna			Stanovanjska - dvosmerna			Stanovanjska - dvosmerna		
e) Vrsta pogona		Večstopenjski pogon			Večstopenjski pogon			Večstopenjski pogon		
f) Vrsta sistema za rekuperacijo toplote		Rekuperacija			Rekuperacija			Rekuperacija		
g) Toplotni izkoristek za rekuperacijo toplote	%	82			82			80		
h) Največja stopnja pretoka pri 100Pa	m ³ /h	102			177			256		
i) Vhodna el. moč pogona ventilatorja pri max. pretoku	W	58			105			105		
j) Nivo zvokovne moči	dBA	50			50			56		
k) Referenčna stopnja pretoka	m ³ /h	71			124			179		
l) Referenčna tlačna razlika	Pa	50			50			50		
m) Specifična vhodna moč	W/m ³ /h	0,352			0,412			0,385		
n1) Regulacijski faktor		0,65	0,85	1,0	0,65	0,85	1,0	0,65	0,85	1,0
n2) Vrsta regulacije		Lokalni nadzor	Centralni nadzor	Ročni nadzor (ni DCV)	Lokalni nadzor	Centralni nadzor	Ročni nadzor (ni DCV)	Lokalni nadzor	Centralni nadzor	Ročni nadzor (ni DCV)
o1) Deklarirana najvišja stopnja notranjega puščanja	%	2			2,5			1,5		
o2) Deklarirana najvišja stopnja zunanega puščanja	%	1			1			1,5		
p1) Notranja hitrost mešanja	%	N/A			N/A			N/A		
p2) Zunanja hitrost mešanja	%	N/A			N/A			N/A		
q) Položaj in opis vidnega opozorila za filter		vidno opozorilo			vidno opozorilo			vidno opozorilo		
r) Navodila za namestitvev regulirne rešetke		N/A			N/A			N/A		
s) Internetni naslov z navodili za montažo										
t) Občutljivost pretoka zraka na spremembe tlaka	%	N/A			N/A			N/A		
u) Notranja / zunanja zračna tesnost	m ³ /h	N/A			N/A			N/A		
v1) Letna poraba električne energije - toplo podnebje AEC	kWh	2,3	3,5	4,4	2,2	3,7	5,2	2	3,5	4,8
v2) Letna poraba električne energije - povprečno podnebje AEC	kWh	2,3	3,5	4,9	2,6	4,2	5,6	2,5	3,9	5,3
v3) Letna poraba električne energije - hladno podnebje AEC	kWh	2,3	3,5	10,2	8,0	9,6	11,0	7,9	9,3	10,7
w1) Prihranjeno letno ogrevanje - toplo podnebje AEC	kWh	20,5	20	19,6	20,5	19,9	19,6	20,3	19,7	19,3
w2) Prihranjeno letno ogrevanje - povprečna klima AEC	kWh	45,3	44,1	43,3	45,3	44,1	43,2	44,9	43,6	42,6
w3) Prihranjeno letno ogrevanje - hladno podnebje AEC	kWh	88,6	86,3	84,6	88,5	86,3	84,6	87,8	85,3	83,4
Glasnost pri 3m (1) pri različni hitrosti	dB (A)	18			21			21		
Temperatura prostora max.	°C	+40			+40			+40		
Stopnja zaščite IP		X4			X4			X4		



CE

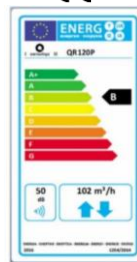

CE

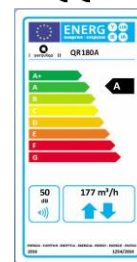

CE

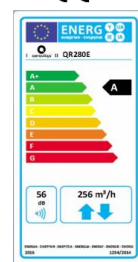

TEHNIČNI OPIS

QR120P

Teža 11,5 kg

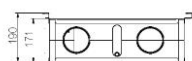
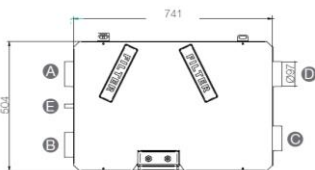

QR180A

Teža 20kg

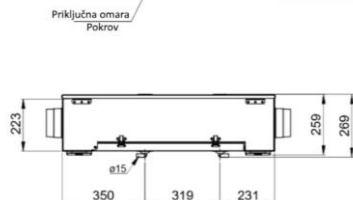
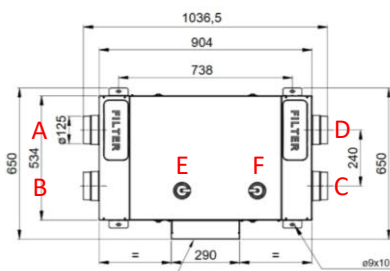

QR280A

Teža 21kg

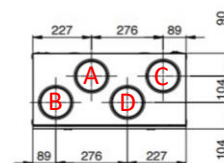
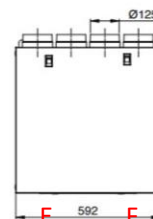

- A Zunanji zajem zraka
- B Izpust zunanji
- C Dovod zraka v prostor
- D Odvzem zraka iz prostora
- E Odvod kondenza - zima
- F Odvod kondenza - poletje

Podatkovni list : Evropska direktiva – ErP, Uredbe 1253/2014-1254/2014

CENTRALNE REKUPERACIJSKE NAPRAVE

a) Blagovna znamka

b) Oznaka modela

c) Razred SEC

c1) Razred SEC toplo podnebje

kWh/m²

c2) Razred SEC zmerno podnebje

kWh/m²

c3) Razred SEC hladno podnebje

kWh/m²

Energijska nalepka

d) Tip naprave

e) Vrsta pogona

f) Vrsta sistema za rekuperacijo toplote

g) Toplotni izkoristek za rekuperacijo toplote

%

h) Največja stopnja pretoka pri 100Pa

m³/h

i) Vhodna el. moč pogona ventilatorja pri max. pretoku

W

j) Nivo zvokovne moči

dBA

k) Referenčna stopnja pretoka

m³/h

l) Referenčna tlačna razlika

Pa

m) Specifična vhodna moč

W/m³/h

n1) Regulacijski faktor

n2) Vrsta regulacije

o1) Deklarirana najvišja stopnja notranjega puščanja

%

o2) Deklarirana najvišja stopnja zunanega puščanja

%

p1) Notranja hitrost mešanja

%

p2) Zunanja hitrost mešanja

%

q) Položaj in opis vidnega opozorila za filter

r) Navodila za namestitev regulirne rešetke

s) Internetni naslov z navodili za montažo

t) občutljivost pretoka zraka na spremembe tlaka

%

u) Notranja / zunanja zračna tesnost

m³/h

v1) Letna poraba električne energije - toplo podnebje AEC

kWh

v2) Letna poraba električne energije - povprečno podnebje AEC

kWh

v3) Letna poraba električne energije - hladno podnebje AEC

kWh

w1) Prihranjeno letno ogrevanje - toplo podnebje AEC

kWh

w2) Prihranjeno letno ogrevanje - povprečna klima AEC

kWh

w3) Prihranjeno letno ogrevanje - hladno podnebje AEC

kWh

Glasnost pri 3m (1) pri različni hitrosti

dB (A)

Temperatura prostora max.

°C

Stopnja zaščite IP

Označevanje / Oznaka

220-240V ~ 50Hz

Zmogljivost zraka, izmerjena po ISO 5801 a 230V 50Hz, gostota zraka 1,2 kg/m³.

Podatki so izmerjeni v priznanem laboratoriju TÜV Rheinland v Aeraulij glede na Tehnični list IEC OD 2048 (level CTF1) za IEC 60335-1 in IEC 60335-2-80 Standard.



(1) Zvočna obremenitev pri 3m v prostem polju, preboj, pri 40% hitrosti, samo za primerjalne namene

AERAULIQA

	QR340A			QR400A			QR550A		
	A	A	B	A	A	B	A	A	B
	-15,8	-12,0	-8,5	-17,3	-14,4	-11,8	-15,0	-10,7	-6,7
	-40,3	-35,8	-31,4	-42,1	-38,7	-35,7	-39,4	-34,4	-30,0
	-83,2	-77,5	-66,8	-80,8	-76,6	-72,9	-77,4	-71,3	-66,1
	Da			Da			Da		
	Stanovajska - dvosmerna			Stanovajska - dvosmerna			Stanovajska - dvosmerna		
	Večstopenski pogon			Večstopenski pogon			Večstopenski pogon		
	Rekuperacija			Rekuperacija			Rekuperacija		
	80			86			82		
	300			363			520		
	170			160			333		
	53			52			58		
	210			254			364		
	50			50			50		
	0,343			0,268			0,412		
	0,65	0,85	1,0	0,65	0,85	1,0	0,65	0,85	1,0
	Lokalni nadzor	Centralni nadzor	Ročni nadzor (ni DCV)	Lokalni nadzor	Centralni nadzor	Ročni nadzor (ni DCV)	Lokalni nadzor	Centralni nadzor	Ročni nadzor (ni DCV)
	2,5			0,6			0,8		
	1			0,4			0,5		
	N / A			N / A			N / A		
	N / A			N / A			N / A		
	vidno opozorilo			vidno opozorilo			vidno opozorilo		
	N / A			N / A			N / A		
	N / A			N / A			N / A		
	N / A			N / A			N / A		
	1,8	3,1	4,3	1,4	2,4	3,4	2,2	3,7	5,2
	1,8	3,1	4,7	1,9	2,9	3,8	2,6	4,2	5,6
	1,8	3,1	10,1	7,2	8,3	9,2	8,0	9,6	11,0
	20,3	19,7	19,3	20,8	20,4	20,1	20,5	20	19,6
	44,9	43,6	42,6	46,1	45,2	44,5	45,3	44,2	43,4
	87,8	85,3	83,4	90,2	88,5	87,1	88,7	86,5	84,8
	22			21			34		
	+40			+40			+40		
	X4			X4			X4		

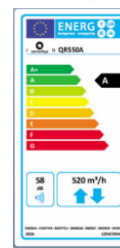
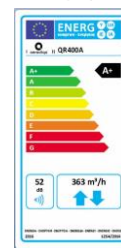
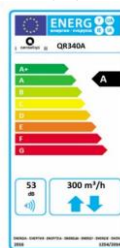

TEHNIČNI OPIS

QR340A

Teža 23,5kg

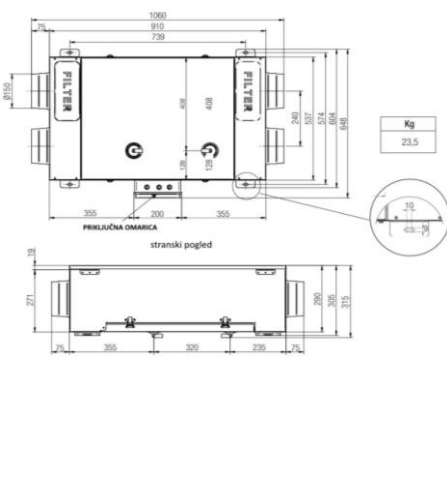

QR400A

Teža 34,5kg

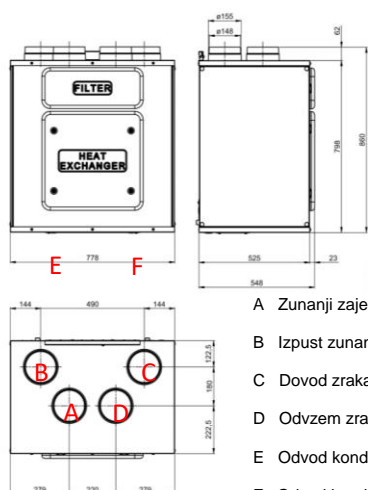

QR550A

Teža 44kg

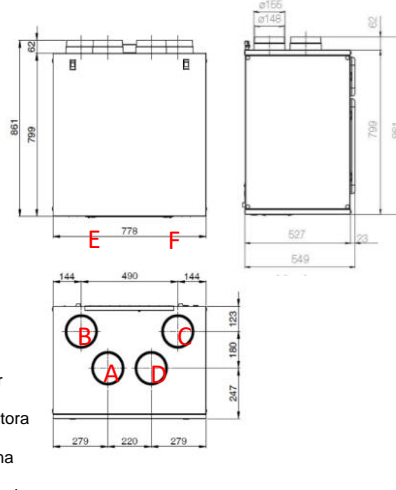

- A Zunanji zajem zraka
- B Izpust zunanji
- C Dovod zraka v prostor
- D Odvzem zraka iz prostora
- E Odvod kondenza - zima
- F Odvod kondenza - poletje

CENTRALNA REKUPERACIJA

REKUPERACIJSKE NAPRAVE Z ENTALPIJSKIMI IZMENJEVALCI



Koda	EAN	Naziv	Cena
001411	8058647114477	QR230E centralna prezračevalna naprava 202m ³ /h z avtomatskim bypasom in entalpijskim izmenjevalcem	2.266,76
004341	8058647114446	QR280E centralna prezračevalna naprava 256m ³ /h z avtomatskim bypasom in entalpijskim izmenjevalcem	2.699,86
001413	8058647114491	QR590E centralna prezračevalna naprava 561m ³ /h z avtomatskim bypasom in entalpijskim izmenjevalcem	3.640,48

Centralne prezračevalne naprave z entalpijskim izmenjevalcem so namenjene za neprekinjen odzem toplote vlažnega zraka, odvzeta iz vlažnih prostorov, in dogrevanje svežega zraka, ki je speljan v bivalne prostore. Enostaven sistem za vsak prostor zagotavlja pravilno prezračevanje - hitro črpanje povečane ravni vlage ali onesnaževal. Predhodno ogrevanje / ohlajanje svežega zraka zmanjša potrebo po dodatnem ogrevanju oz. klimatizaciji. EC krtačni motorji bistveno zmanjšajo porabo električne energije. Pravilno vzdrževani filtri preprečujejo vstop cvetnega prahu v prostor.

Toplotni izmenjevalec omogoča visoko entalpijo toplote (85%) in vlage (65%). Zmanjšuje padce tlaka. Protimikrobna polimerna membrana, odporna na bakterije, zaustavlja razvoj plesni in kontaminacijo zraka, ter blokira vonjave. Čiščenje je enostavno.

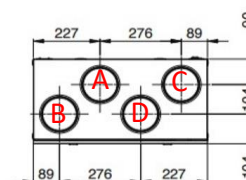
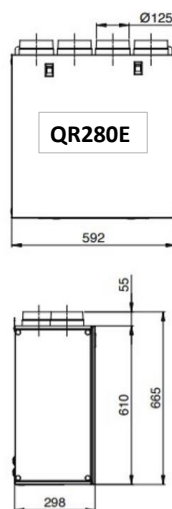
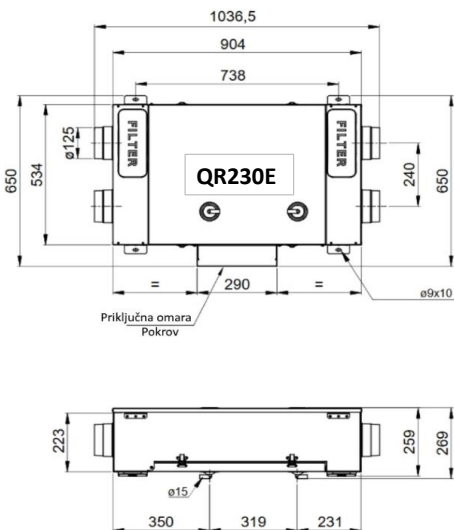

- A Zunanji zajem zraka
- B Izpust zunanji
- C Dovod zraka v prostor
- D Odvzem zraka iz prostora

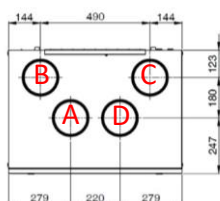
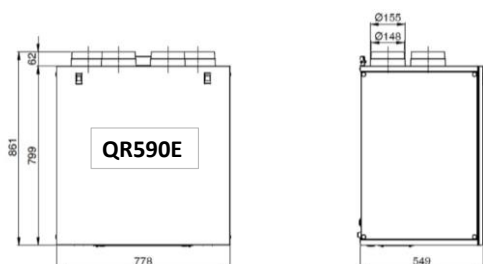

KONTROLNA PLOŠČA CTRL-DSP

Kontrolna plošča z LCD zaslonom za samodejni nadzor omogoča 3 nastavitve hitrosti, Boost-povečanje hitrosti, počitniški način, nočni način, tedensko nastavitve, bypass nastavitve, nastavitve pretoka zraka, opozorilnik zamenjave filtra in okvare ventilatorja, merilnik časa delovanja, nastavitve varčevanja in nalaganja, primerno za daljinske senzorje (SEN-HY, SEN-PIR, SEN-CO2), vmesnik Mod-bus, povezano na daljinsko ogrevanje, možnost prilagajanja vremenskim spremembam.

Podatkovni list : Evropska direktiva – ErP, Uredbe 1253/2014-1254/2014

REKUPERACIJSKE NAPRAVE Z ENTALPIJSKIMI IZMENJEVALCI

		AERAVLIQA								
		QR230E			QR280E			QR590E		
		A	B	B	A	B	B	A	B	B
a) Blagovna znamka										
b) Oznaka modela										
c) Razred SEC										
c1) Razred SEC toplo podnebje	kWh/m ²	-14,6	-10,4	-6,6	-14,3	-9,8	-5,8	-14,9	-10,8	-7,2
c2) Razred SEC zmerno podnebje	kWh/m ²	-37,6	-32,3	-27,8	-37,2	-31,7	-26,9	-38,0	-32,9	-28,6
c3) Razred SEC hladno podnebje	kWh/m ²	-73,1	-66,0	-60,1	-72,8	-65,4	-59,3	-73,7	-66,9	-61,2
Energijska nalepka		Da			Da			Da		
d) Tip naprave		Stanovanjska - dvosmerna			Stanovanjska - dvosmerna			Stanovanjska - dvosmerna		
e) Vrsta pogona		Večstopenjski pogon			Večstopenjski pogon			Večstopenjski pogon		
f) Vrsta sistema za rekuperacijo toplote		Rekuperacija			Rekuperacija			Rekuperacija		
g) Toplotni izkoristek za rekuperacijo toplote	%	70			70			71		
h) Največja stopnja pretoka pri 100Pa	m ³ /h	202			256			561		
i) Vhodna el. moč pogona ventilatorja pri max. pretoku	W	114			160			343		
j) Nivo zvokovne moči	dBA	50			56			58		
k) Referenčna stopnja pretoka	m ³ /h	142			179			393		
l) Referenčna tlačna razlika	Pa	50			50			50		
m) Specifična vhodna moč	W/m ³ /h	0,359			0,385			0,344		
n1) Regulaijski faktor		0,65	0,85	1,0	0,65	0,85	1,0	0,65	0,85	1,0
n2) Vrsta regulacije		Lokalni nadzor	Centralni nadzor	Ročni nadzor (ni DCV)	Lokalni nadzor	Centralni nadzor	Ročni nadzor (ni DCV)	Lokalni nadzor	Centralni nadzor	Ročni nadzor (ni DCV)
o1) Deklarirana najvišja stopnja notranjega puščanja	%	2,5			1,5			0,8		
o2) Deklarirana najvišja stopnja zunanjega puščanja	%	1			1,5			0,5		
p1) Notranja hitrost mešanja	%	N / A			N / A			N / A		
p2) Zunanja hitrost mešanja	%	N / A			N / A			N / A		
q) Položaj in opis vidnega opozorila za filter										
r) Navodila za namestitev regulirne rešetke		N / A			N / A			N / A		
s) Internetni naslov z navodili za montažo										
t) Občutljivost pretoka zraka na spremembe tlaka	%	N / A			N / A			N / A		
u) Notranja / zunanja zračna tesnost	m ³ /h	N / A			N / A			N / A		
v1) Letna poraba električne energije - toplo podnebje AEC	kWh	1,9	3,3	4,5	2	3,5	4,8	1,8	3,1	4,3
v2) Letna poraba električne energije - povprečno podnebje AEC	kWh	2,4	3,7	4,9	2,5	3,9	5,3	2,3	3,6	4,8
v3) Letna poraba električne energije - hladno podnebje AEC	kWh	7,7	9,1	10,3	7,9	9,3	10,7	7,6	8,9	10,1
w1) Prihranjeno letno ogrevanje - toplo podnebje AEC	kWh	19,4	18,5	17,8	19,4	18,5	17,8	19,4	18,6	18
w2) Prihranjeno letno ogrevanje - povprečna klima AEC	kWh	42,8	40,9	39,4	42,8	40,9	39,4	43	41,2	39,8
w3) Prihranjeno letno ogrevanje - hladno podnebje AEC	kWh	83,7	80	77,2	83,7	80	77,2	84,1	80,5	77,8
Glasnost pri 3m (1) pri različni hitrosti	dB (A)	21			21			21		
Temperatura prostora max.	°C	+40			+40			+40		
Stopnja zaščite IP		X4			X4			X4		



Označevanje / Oznaka

220-240V ~ 50Hz

Zmogljivost zraka, izmerjena po ISO 5801 a 230V 50Hz, gostota zraka 1,2 kg/m³.



Podatki so izmerjeni v priznanem laboratoriju TÜV Rheinland v Aeravliqi glede na Tehnični list IEC OD 2048 (level CTF1) za IEC 60335-1 in IEC 60335-2-80 Standard.

(1) Zvočna obremenitev pri 3m v prostem polju, preboj, pri 40% hitrosti, samo za primerjalne namene

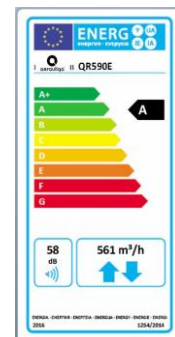
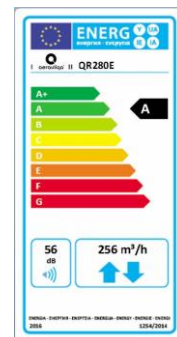
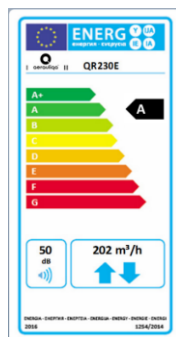

RAZDELILNE KOMORE



Koda	000575	003750	000002	000003	000004
EAN					
Naziv	Razdelilna komora DN150mm 2 x DN125	Razdelilna komora DN125mm 4 x DN75	Razdelilna komora DN125mm 6 x DN75	Razdelilna komora DN160mm 10 x DN75	Razdelilna komora DN160mm 15 x DN75
Cena	86,99	101,14	165,31	176,66	205,20

PREZRAČEVALNE KOMORE

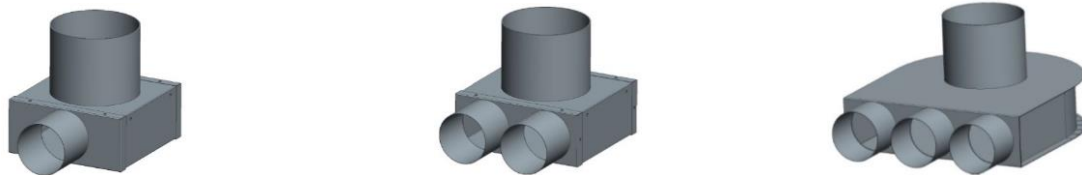

Koda	AERKOM1/75	AERKOM2/75	AERKOM 3/75
EAN			
Naziv	Prezračevalna komora 90° Ø75 mm za PV 125	Prezračevalna komora 90° 2x Ø75 mm za PV 125	Prezračevalna komora 90° 3x Ø75 mm za PV 125
Cena	32,94	35,38	37,58

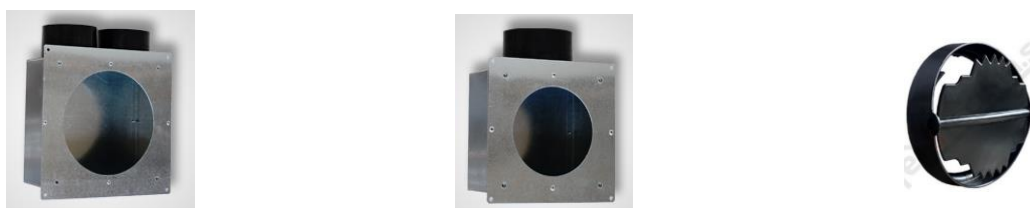

Koda	000767	000748	005168
EAN			
Naziv	Prezračevalna komora PLML stenska, 2x Ø75, komora 200 x 200mm	Prezračevalna komora PLML stenska, 1x Ø75mm, komora 140x140mm	Regulator / dušilec zvoka za stensko komoro PLML in PLMP Ø80 TUNE80 SILENT (3 kosi)
Cena	39,89	32,82	7,08



Koda	000594	001079	2552VFE70
EAN			4010184025528
Naziv	BCRG100 eleganten pokrov, Ø100, za komoro 000748, 000767	BCRG125 eleganten pokrov, Ø125, za komoro 000748, 000767	Zajemna komora VFE 70 s filtrom za kuhinje
Cena	17,08	19,89	97,83

PREZRAČEVALNE KOMORE

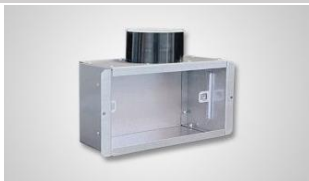

Koda	005226
Naziv	Prezračevalna komora PLMLS stenska, 1 x ø75 na 200 x 100mm, priključek s strani
Cena	36,97



Koda	005227
Naziv	Prezračevalna komora PLMLS stenska, 2 x ø75 na 300 x 100mm, priključka s strani
Cena	45,63



Koda	005258
Naziv	Prezračevalna komora PLMLS stenska, 3 x ø75 na 300 x 100mm, priključki s strani
Cena	55,63

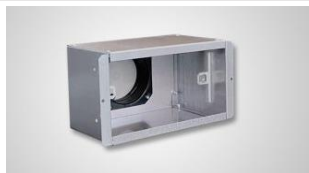

Koda	005228
Naziv	Prezračevalna komora PLMPS stenska, 1 x ø75 na 200 x 100mm, priključek zadaj
Cena	38,43



Koda	005229
Naziv	Prezračevalna komora PLMPS stenska, 2 x ø75 na 300 x 100mm, priključka zadaj
Cena	45,63



Koda	005259
Naziv	Prezračevalna komora PLMPS stenska, 3 x ø75 na 300 x 100mm, priključki zadaj
Cena	49,53



Koda	005260
Naziv	Prezračevalna komora PLMLCS stenska, 1 x ø75 na 200 x 100mm, priključek s strani
Cena	39,89



Koda	003730
Naziv	Rešetka GRLFQ bela 200x100mm za stensko prezračevalno komoro z magneti
Cena	41,36



Koda	003731
Naziv	Rešetka GRLFQ bela 300x100mm za stensko prezračevalno komoro z magneti
Cena	41,36

Koda	000779
Naziv	Rešetka GRLFOR bela 300x100mm za stensko prezračevalno komoro
Cena	15,62

Koda	003729
Naziv	Rešetka GRLFT bela 300x100mm za stensko prezračevalno komoro z magneti
Cena	41,36

FILTRI ZA REKUPERACIJSKE ENOTE - rezervni deli



Koda	Naziv	Cena
005253	Filter G4-KF120G4 za QR180 / QR230	39,89
003699	Filter G4-KF180G4 za QR180 / QR230	35,62
001676	Filter G4-KF280G4 za QR280 / QR350	35,62
005561	Filter G4-KF340G4 za QR340	35,62
003697	Filter G4-KF400G4 za QR400 / QR550 / QR590	36,59
005255	Filter F7-KF120F7 za QR180 / QR230	55,63
001809	Filter F7-KF280F7 za QR280 / QR350	59,78
005562	Filter F7-KF340F7 za QR340	59,78
003698	Filter F7-KF400F7 za QR400 / QR550 / QR590	51,24

FILTRI ZA LOKALNE REKUPERATORJE



Koda	Naziv	Cena
004636	KFNext100 4 x filter ø100 za lokalni rekuperator Quantum HR in BCRG	8,54
003918	KFNext100 4 x filter ø150 za lokalni rekuperator Quantum HR in BCRG	8,54
001080	KF100HR 3 x filter ø100 za lokalni rekuperator Quantum HR in BCRG	5,61
001081	KF150HR 3 x filter ø150 za lokalni rekuperator Quantum HR in BCRG	7,08

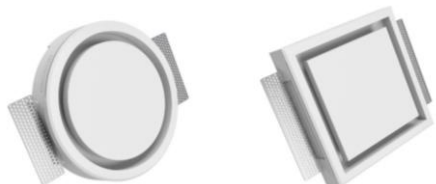
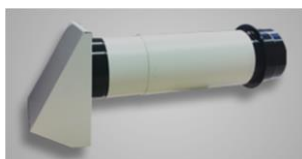

CEVI ZA PREZRAČEVALNE SISTEME

Koda	EAN	Naziv	DN	Cena
AECEV75	3840207550307	Prezračevalna cev 1m	75	3,27
		Antistatična, antibakterijska	50m v kolutu	163,48
001538	8011963763675	Koleno 90° za cev DN75		20,37
9395		Cevna objemka IP-S 125	125	9,86
9392		Cevna objemka IP-S 160	160	9,86
AESPOJKA75		Spojka za cev	75	2,31
AETES75		Tesnilo za cev	75	2,31
AECEP75		Čep za cev	75	1,34

IZOLIRANI ZRAČNI KANALI

Koda	EAN	Naziv	DN	Cena
9406	4010184094067	Izolirana cev IP 125/2000 mm		56,93
9447	4010184094470	Izolirana cev IP 160/2000 mm		69,75
9399	4010184093992	Izolirano koleno IP-B 125/45°		12,81
9449	4010184094494	Izolirano koleno IP-B 160/45°		12,81
9398	4010184093985	Izolirano koleno IP-B 125/90°		24,40
9451	4010184094517	Izolirano koleno IP-B 160/90°		24,16
9394	4010184093947	Spojni kos za izolirano cev IP-MU125		8,63
9453	4010184094531	Spojni kos za izolirano cev IP-IV160		8,63
8311SVE	4010184083115	Dušilec zvoka in regulator pretoka SVE 125		13,55
8312SVE	4010184083122	Dušilec zvoka in regulator pretoka SVE 160		17,25
DUS125		Dušilec zvoka gibljivi	125/180	79,30
DUS160		Dušilec zvoka gibljivi	160/200	91,50
DUS200		Dušilec zvoka gibljivi	200/200	128,10

ZUNANJE REŠETKE

Koda	EAN	Naziv	DN	Cena
000513		Zunanja rešetka z stensko cevjo KIT DN125		76,86
000538		Zunanja rešetka z stensko cevjo KIT DN150		82,96
Koda	EAN	Naziv	DN	Cena
000631		Zunanja rešetka inox	125	32,94
000632		Zunanja rešetka inox	150	34,16
ND12FV	4750492011348	Zunanja rešetka PVC 190 x 190mm bela	125	5,89
ND15FV	4750492011386	Zunanja rešetka PVC 190 x 190mm bela	150	5,89
Koda	EAN	Naziv	Cena	
DM125	4750492000595	Odvodni kovinski kanalski zračni ventil Ø125mm	7,96	
DMP125	4750492000656	Dovodni kovinski kanalski zračni ventil Ø125mm	7,96	
VD125	4750492000120	PV kanalski ventil Ø125mm	7,35	
VDA125	4750492000182	PV kanalski ventil z vzmetjo Ø125mm	7,55	
DMKP125	4750492013281	Kovinski zračni ventil Ø125mm	15,66	

PREZRAČEVALNI DIFUZORJI BREZ OKVIRJA

Koda	Naziv	Cena
ERGO-RONDO125	Zračni ventil RONDO125, univerzalni ø125mm	92,72
ERGO-KVADRO125	Zračni ventil KVADRO125, univerzalni ø125mm	101,26

*Po naročilu

PVC REKUPERACIJSKI SISTEM OVA - komore, priključki, cevi



NOVO!

Koda	Naziv	Cena
OVA-AST2X75_300	OVA Stropna komora z dvema priključkoma ø75 / 125 - 300mm	25,93

OVA-LSR125	OVA Dušilec zvoka in regulator pretoka ø125mm	13,42
-------------------	---	--------------

Koda	Naziv	Cena
OVA-MODUL160	OVA Modulair razdelilna komora s priključkom ø160mm Set vsebuje zgornjo in spodnjo stranico in vijake.	51,85

Koda	Naziv	Cena
OVA-MODULFULL	OVA Modulair dodatna razdelilna komora - razširitev Set vsebuje 2x polno stranico in vijake.	51,85



Največje število priključkov na sestavljeni komori je 12.



Možnost združevanja razdelilnih komor v večje module.

Koda	Naziv	Cena
OVA-MODUL-PRIK.	OVA Modulair stranica s priključki 3 x ø75mm	10,98

Koda	Naziv	Cena
OVA-MODUL-PLATA	OVA Modulair polna stranica komore	4,64

Koda	Naziv	Cena
OVA-ZAT75	OVA Zatič za cev ø75mm (rezervni del)	

Koda	Naziv	Premer	Cena/m
OVA-CEV75PREMIUM	OVA Gibljiva cev Silver Premium 75S Antistatična, antibakterijska	ø75mm bela	3,27

Koda	Naziv	Premer	Cena/m
OVA-CEV75S *	OVA Gibljiva cev Silver Standard 30S Antistatična	ø75mm siva	2,32

Koda	Naziv	Cena
OVA-WN75	OVA Tesnilo za cev ø75mm (oranžno)	1,37

Koda	Naziv	Premer	Cena/m
OVA-PIPE160	OVA Cev izolirana EPP ø160-1500mm	ø160mmr črna	53,68



Debelina izolacije 25mm.

Koda	Naziv	Premer	Cena
OVA-LOK160	OVA Koleno izolirano EPP ø160 - 90°	ø160mmr črno	26,84

Debelina izolacije 25mm.

Koda	Naziv	Cena
OVA-MUFA160	OVA Spojni kos PP ø160mm	9,76

OVA-OPASKA160	OVA Cevna objemka ø160 mm	1,10
----------------------	---------------------------	-------------

REKUPERACIJA - PREZRAČEVALNE KOMORE

Koda	Naziv	Cena
AWE_VPB125-2	AWENTA PRO VPB125-2, prezračevalna komora 2 x DN75, stropna	20,62

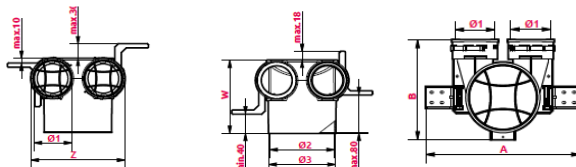

Dimenzije (mm)

ø1	ø2	ø3	A	B	Z	W
75	128	134	277	189	186	152

Koda	Naziv	Cena
AWE_VPB125-3	AWENTA PRO VPB125-3, prezračevalna komora 3 x DN75, stropna	23,55

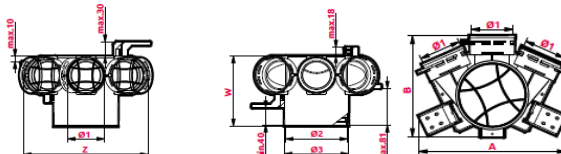

Dimenzije (mm)

ø1	ø2	ø3	A	B	Z	W
75	128	134	268	195	257	152

Koda	Naziv	Cena
AWE_VPE125-2	AWENTA PRO VPE125-2, prezračevalna komora 2 x DN75, stenska	12,69

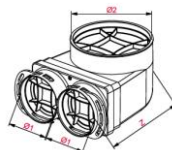

Dimenzije (mm)

ø1	ø2	Z
75	128	202

Koda	Naziv	Cena
AWE_VPC125-2	AWENTA PRO VPC125-2, prezračevalna komora 2 x DN75, stenska	12,20

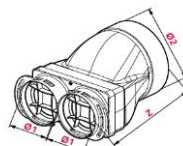

Dimenzije (mm)

ø1	ø2	Z
75	128	194

Koda	Naziv	Cena
AWE_VCB160-6	AWENTA PRO VCB160-6, razdelilna komora 6 x DN75, ø160mm	77,59

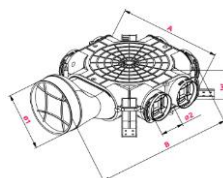

Dimenzije (mm)

ø1	ø2	A	B	W
160	75	347	475	104

Koda	Naziv	Cena
AWE_VCB160-10	AWENTA PRO VCB160-10, razdelilna komora 10 x DN75, ø160mm	146,38

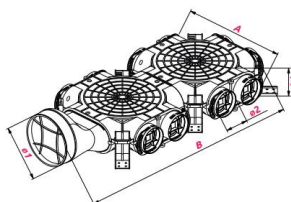

Dimenzije (mm)

ø1	ø2	A	B	W
160	75	347	766	104

Koda	Naziv	Cena
AWE_VCB160-14	AWENTA PRO VCB160-14, razdelilna komora 14 x DN75, ø160mm	199,23

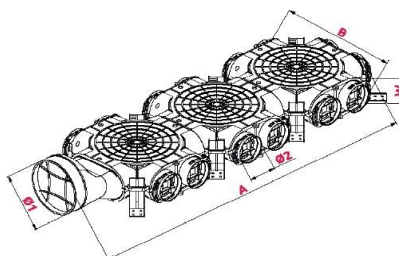

Dimenzije (mm)

ø1	ø2	A	B	W
160	75	347	1057	104

REKUPERACIJA - PREZRAČEVALNE KOMORE

Koda	Naziv	Cena
AWE_VMK75-2-L	AWENTA PRO VMK75-2-L dolgi cevni prehod 2 x DN77	73,08

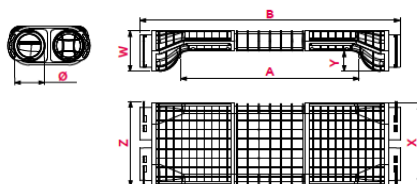

Dimenzije (mm)					
ø	W	A	B	Z	X
75	100	437	637	210	200

REKUPERACIJA - CEVNI VENTILATOR

Koda	Naziv	Cena
AWE_VTR100DT	AWENTA VTR100DT cevni ventilator, časovnik	76,23

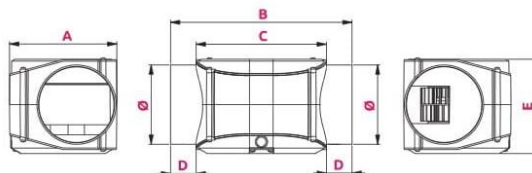

Dimenzije (mm)					
ø	A	B	C	D	E
100	136	230	165	32	119,5

REKUPERACIJA - VENTILI

Koda	Naziv	Cena
AWE_VAK125	AWENTA PRO VAK125 prezračevalni ventil dovodni/odvodni ø125mm	25,13

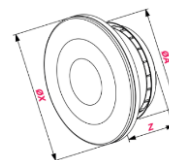

Dimenzije (mm)		
øA	øx	Z
125	173	54

Koda	Naziv	Cena
AWE_VAPO125	AWENTA PRO VAPO125 prezračevalni ventil dovodni/odvodni ø125mm	18,91

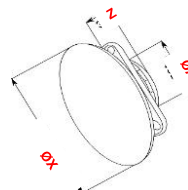

Dimenzije (mm)		
øA	øx	Z
125	173	54

Koda	Naziv	Cena
AWE_VAN75	AWENTA PRO VAN75 prezračevalni ventil dovodni ø75mm	8,54

Koda	Naziv	Cena
AWE_VAW75	AWENTA PRO VAW75 prezračevalni ventil odvodni ø75mm	

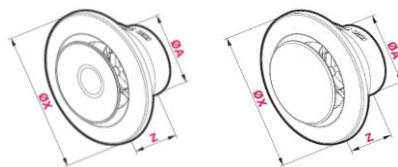

Dimenzije (mm)		
øA	øx	Z
75	155	65

Koda	Naziv	Cena
AWE_VU75-5	AWENTA PRO VU75-5 tesnilo za cev ø75mm	0,98



Koda	Naziv	Cena
AWE_VNK75G	AWENTA PRO VNK75G rezilo za rekuperacijske cevi ø75mm	3,78



*Po naročilu

*Odprodaja



AKSIALNI VENTILATOR iCON 15 Basic

Koda	EAN	Napetost (V)	Moč (W)	Pretok zraka (m³/h)	Glasnost (dB)	Priključna cev (Ø/m)	Teža (kg)	Cena
iCON15	5019009303468	230V	7,5	68	30,3	100/4	0,74	145,18
Funkcijski moduli PCM, TM, HTM, PRTM, PRHTM. IPX4.								
iCON15S12V	5019009303666	12V	7,5	68	30,3	100/4	0,74	591,70

Funkcijski moduli PCS, PCTS, DTS, PRTS, IPX4.
Z ohišjem. Za vlažne prostore.
Priložen 12V DC transformator dim.115 x 50 x 33mm.
ECO-nizka poraba, tiho delovanje, samozapiralna krilca zmanjšujejo izgube toplote, vdor zunanega hladnega zraka in zvoka.



AKSIALNI / CENTRIFUGALNI VENTILATOR iCON 30 Basic

Koda	EAN	Napetost (V)	Moč (W)	Pretok zraka (m³/h)	Glasnost (dB)	Priključna cev (Ø/m)	Teža (kg)	Cena
iCON30 *	5019009303601	230V	13	118	33,6	100/9	1,11	280,60
Funkcijski moduli PCM, TM, HTM, PRTM, PRHTM. IPX4.								
ICON30S12V*	5019009303673	12V	13	118	33,6	100/9	1,11	716,14

Funkcijski moduli PCS, PCTS, DTS, PRTS, IPX4.
Z ohišjem. Za vlažne prostore.
Priložen 12V DC transformator dim.115 x 50 x 33mm.
ECO-nizka poraba, tiho delovanje, samozapiralna krilca zmanjšujejo izgube toplote, vdor zunanega hladnega zraka in zvoka.



AKSIALNI / CENTRIFUGALNI VENTILATOR iCON 60 Basic

Koda	EAN	Napetost (V)	Moč (W)	Pretok zraka (m³/h)	Glasnost (dB)	Priključna cev (Ø/m)	Teža (kg)	Cena
iCON60	5019009303482	240V	75	260	42	150/9	1,97	330,62

Funkcijski moduli PCM, TM, HTM, PRTM, PRHTM. IPX4.
Z ohišjem. Za kuhinje, večje kopalnice in bivalne prostore.

FUNKCIJSKI MODULI za VENTILATORJE iCON Basic

Koda	EAN	Moduli za iCON 230V	Cena
PCM	5019009303369	Modul - potezna vrstica	46,36
TM	5019009303499	Modul - nastavljen timer 1-30min	46,36
HTM	5019009311708	Modul - senzor vlage 40 - 90%, timer, vrstica	95,16
PRTM*	5019009303390	Modul - senzor gibanja, timer	192,76
PRHTM*	5019009303376	Modul - senzor gibanja, senzor vlage, timer	213,50

Koda	EAN	Moduli za iCON SELV 12V DC	Cena
PCS*	5019009303512	Modul - potezna vrstica	46,36
PCTS*	5019009303444	Modul - nastavljen timer 1-30min	81,74

DIMENZIJE VENTILATORJEV

(mm)	iCON15	iCON30	iCON60
A	197	225	280
B		141,3	165,4
C		29,4	46,5
D		97,5	147,9
E	52	100,9	115
F	92	144,3	170,3
G	100	147,9	176,8
H	40	43	55

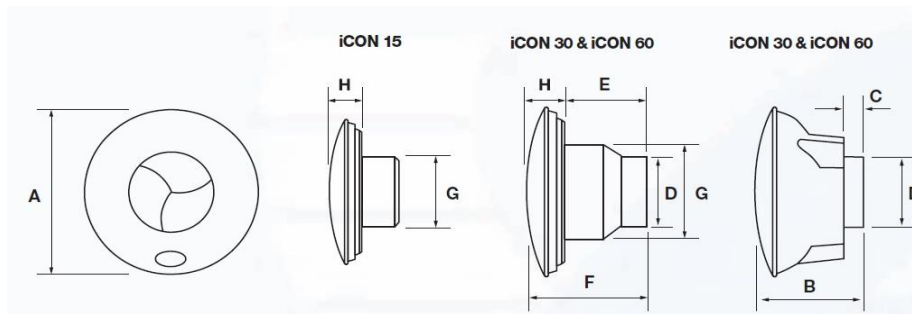

Barve pokrovov ventilatorjev po naročilu: srebrna, antracit, zlata, krom

*Odprodaja

CENTRIFUGALNI KOPALNIŠKI VENTILATOR QX z nepovratno loputo

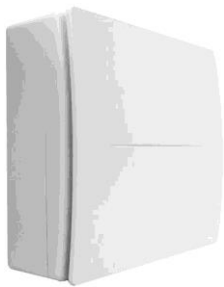

Koda	EAN	Naziv	Cena
PQX00012		Centrifugal QX 80T (priključ.cev Ø80, timer, 2 hitrosti, nepovr. loputa)	92,60
PQX00013	8058647111933	Centrifugal QX 80HT (priključ.cev Ø80, senzor vlage, timer, 2 hitrosti)	106,87
PQX00014	8058647111995	Centrifugal QX 100 (priključna cev Ø100, 2 hitrosti)	76,98
PQX00015	8058647112015	Centrifugal QX 100T (priključna cev Ø100 timer, 2 hitrosti)	92,60
PQX00016	8058647112039	Centrifugal QX 100HT (priključ.cev Ø100, timer, senzor vlage, 2 hitrosti)	106,87

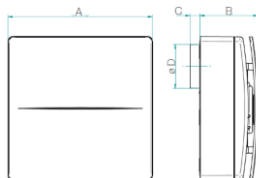

Dimenzije		
	QX80	QX100
A	241,5	241,5
B	96,5	96,5
C	17	17
ØD	73,5	96,0
Teža kg	1,8	1,8

CENTRIFUGALNI KOPALNIŠKI VENTILATOR QXD z dodatnim cevnim izhodom in nepovratno loputo



Koda	EAN	Naziv	Cena
004633	8058647114262	Centrifugalni ventilator QXD100	91,13
004646	8058647114286	Centrifugalni ventilator QXD100T (timer)	106,87
004647	8058647114309	Centrifugalni ventilator QXD100HT (timer, senzor vlage)	122,49

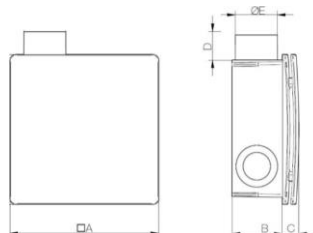

Dimenzije		
	QXD100, 100T, 100HT	
A	265	
B	119	
C	29,0	
ØD	50	
ØE	75	
Teža kg	2,25	

AKSIALNI VENTILATOR QD100HT s časovnikom in senzorjem vlage



Koda	EAN	Naziv	Cena
1792		Aksialni ventilator QD100HT (timer, senzor vlage)	49,90

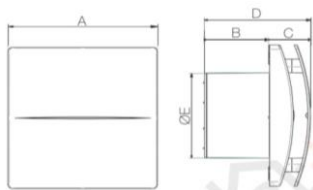

Dimenzije		
	QD100HT	
A	164	
B	70	
C	47	
D	116	
ØE	99	
Teža kg	0,6	

ENOSMERNI AKSIALNI VENTILATOR MX za neprekinjeno delovanje s časovnikom in senzorjem vlage



Koda	EAN	Naziv	Cena
004635	8058647114002	Quantum MX 100HT (timer, senzor vlage)	156,16
5857		Quantum EX100HT (timer, senzor vlage)	103,70
003686		Zunanja rešetka EG150, za Quantum AX in QR100	7,08

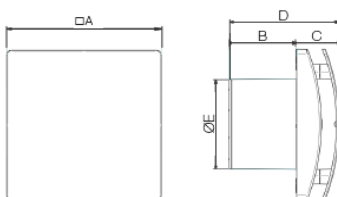

Dimenzije		
	MX100	EX100HT
A	164	164
B	46	46
C	82,0	70
D	ØD= 99	116
ØE	101,0	99
Teža kg	0,6	0,6

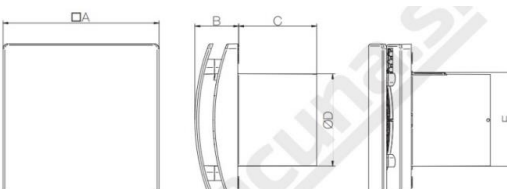

zunanja rešetka

*Odprodaja



STIKALA - opcija

Koda	EAN	Naziv	Cena
PTM00001		Stikalo s timerjem	82,59
003688	8058647113944	Stikalo s senzorjem za regulacijo vlage SEN-HY-1	108,34
003692	8058647113968	Stikalo s senzorjem prisotnosti SRL	141,15
CCM00001*		Stikalo s senzorjem CO2	353,80

Podatkovni list - ErP, v skladu s predpisi Uredbe EU 1253/2014 - 1254/2014

a) Blagovna znamka		AERAULIQA								
b) Oznaka modela		QX80T QX100 QX100T	QX80HT QX100HT	QXD100 QXD100T	QXD100HT	QD100HT	QUANTUM MX100HT	QUANTUM EX100HT		
c) Razred SEC		F	C	F	C	C	C	C		
c1)	Razred SEC toplo podnebje	kWh/m ²	0,8	-7,7	1,1	-7,5	-9,6	-10,8	-11,2	
c2)	Razred SEC zmerno podnebje	kWh/m ²	-8,6	-23,2	-8,3	-23	-24,0	-25,2	-25,6	
c3)	Razred SEC hladno podnebje	kWh/m ²	-25,0	-50,2	-24,7	-50,1	-49,1	-50,3	-50,7	
Energijska nalepka		Ne	Ne	Ne	Ne	Ne	Ne	Ne		
d) Tip naprave		Stanovanjska - dvosmerna								
e) Vrsta pogona		Večstopenjski pogon								
f) Vrsta sistema za rekuperacijo toplote		Ne	Ne	Ne	Ne	Ne	Ne	Ne		
g) Toplotni izkoristek za rekuperacijo toplote		%	N/A	N/A	N/A	N/A	N/A	N/A		
h) Največja stopnja pretoka pri 100Pa		m ³ /h	104	104	103	103	83	100	84	
i) Vhodna el. moč pogona ventilatorja pri max. pretoku		W	28	28	29	29	8,3	5	4,5	
j) Nivo zvokovne moči		dBA	59	59	50	50	47	43	45	
k) Referenčna stopnja pretoka		m ³ /h	104	104	103	103	83	72	59	
l) Referenčna tlačna razlika		Pa	10	10	10	10	10	10	20	
m) Specifična vhodna moč		W/m ³ /h	0,274	0,274	0,282	0,282	0,1	0,057	0,034	
n1) Regulacijski faktor			1	0,65	1	0,65	0,65	0,65	0,65	
n2) Vrsta regulacije		Lokalni nadzor								
o1) Deklarirana najvišja stopnja notranjega puščanja		%	N/A	N/A	N/A	N/A	N/A	N/A	N/A	
o2) Deklarirana najvišja stopnja zunanega puščanja		%	N/A	N/A	N/A	N/A	N/A	2	N/A	
p1) Stopnja notranjega mešanja		%	N/A	N/A	N/A	N/A	N/A	N/A	N/A	
p2) Stopnja zunanega mešanja		%	N/A	N/A	N/A	N/A	N/A	N/A	N/A	
q) Položaj in opis vidnega opozorila za filter			N/A	N/A	N/A	N/A	N/A	N/A	N/A	
r) Navodila za namestitvev regulirne rešetke		Priložena navodila								
s) Internetni naslov z navodili za montažo		www.aerauliqa.com								
t) Občutljivost pretoka zraka na spremembe tlaka		%	6	6	6	6	N/A	N/A	N/A	
u) Notranja / zunanja zračna tesnost		m ³ /h	27	27	20	20	52	52	52	
v1) Letna poraba električne energije - toplo podnebje AEC		kWh	3,4	2	3,5	2,1	0,9	0,4	0,2	
v2) Letna poraba električne energije - povprečno podnebje AEC		kWh	3,4	2	3,5	2,1	0,9	0,4	0,2	
v3) Letna poraba električne energije - hladno podnebje AEC		kWh	3,4	2	3,5	2,1	0,9	0,4	0,2	
w1) Prihranjeno letno ogrevanje - toplo podnebje AEC		kWh	7,8	12,8	7,8	12,8	11,9	11,9	11,9	
w2) Prihranjeno letno ogrevanje - povprečna klima AEC		kWh	17,2	28,3	17,2	28,3	26,2	26,2	26,2	
w3) Prihranjeno letno ogrevanje - hladno podnebje AEC		kWh	33,6	55,4	33,6	55,4	51,3	51,3	51,3	
Tehnične lastnosti										
Pretok zraka		m ³ /h	62 (min.104)		103 (min.64)		103 (min.64)		90 (min.15)	102 (min.17)
Statični pritisk		Pa max.	142/251		260/164		260/164			
Poraba energije		W	17/28		29/19		29/19		5 (min.1,5)	4,5 (min.0,9)
Glasnost		dB(A)-3m	27/38		30/22		30/22		32 (min.9)	37 (min.9)
Max temp. zraka		°C	do 50°C		do 50 °C		do 50 °C		do 40°C	do 40°C
Stopnja zaščite		IP	X4 stenska vgradnja / X2 stropna vgradnja							

Označevanje / Oznaka

Zmogljivost zraka, izmerjena po ISO 5801 a 230V 50Hz, gostota zraka 1,2 kg/m³.

Podatki so izmerjeni v priznanem laboratoriju TÜV Rheinland v Aerauliqa glede na Tehnični list IEC OD 2048 (level CTF1) za IEC 60335-1 in IEC 60335-2-80 Standard.

(1) Zvočna obremenitev pri 3m v prostem polju, preboj, pri 40% hitrosti, samo za primerjalne namene.



AKSIALNI VENTILATORJI

EA OKROGLI - rešetka



Koda	EAN	Naziv	Cena
EA100	4750492006894	Aksialni ventilator EA Ø100mm	20,50
EA125	4750492006900	Aksialni ventilator EA Ø125mm	22,72
EA150	4750492007532	Aksialni ventilator EA Ø150mm	28,43
EA100T	4750492007556	Aksialni ventilator EA Ø100mm s timerjem	36,25
EA125T	4750492007570	Aksialni ventilator EA Ø125mm s timerjem	39,00
EA150T	4750492007594	Aksialni ventilator EA Ø150mm s timerjem	45,85
EA100HT	4750492007563	Aksialni ventilator EA Ø100mms timerjem in senzorjem vlage	43,16
EA125HT	4750492007587	Aksialni ventilator EA Ø125mms timerjem in senzorjem vlage	45,85
EA150HT	4750492007600	Aksialni ventilator EA Ø150mm s timerjem in senzorjem vlage	52,73



Koda	EAN	Naziv	Cena
EA100A	4750492012505	Aksialni ventilator EA Ø100mm antracit	29,40
EA125A	4750492012512	Aksialni ventilator EA Ø125mm antracit	32,09
EA150A	4750492018439	Aksialni ventilator EA Ø150mm antracit	39,00



EAT OKROGLI - polni pokrov

Koda	EAN	Naziv	Cena
EAT100	4750492009116	Aksialni ventilator EAT Ø100mm	24,27
EAT125	4750492009123	Aksialni ventilator EAT Ø125mm	28,43
EAT150	4750492009130	Aksialni ventilator EAT Ø150mm	35,99
EAT100T	4750492009147	Aksialni ventilator EAT Ø100mm s timerjem	37,13
EAT125T	4750492009154	Aksialni ventilator EAT Ø125mm s timerjem	41,69
EAT150T	4750492009161	Aksialni ventilator EAT Ø150mm s timerjem	50,01
EAT100HT	4750492009178	Aksialni ventilator EAT Ø100mm s timerjem in senzorjem vlage	47,70
EAT125HT	4750492009185	Aksialni ventilator EAT Ø125mm s timerjem in senzorjem vlage	52,73
EAT150HT	4750492009192	Aksialni ventilator EAT Ø150mm s timerjem in senzorjem vlage	61,87

Barvne opcije po naročilu



Antracit

Silver



Gold

Tehnični podatki

	EA100	EA125	EA150	EAT100	EAT125	EAT150
Napetost (V)	220 - 240V-50Hz			220 - 240V-50Hz		
Moč (W)	15	16	20	15	16	20
Pretok m³/h	100	150	200	100	150	200
Raven hrupa: 3m razdalja, Lp A dB(A)	32	36	40	32	36	40
Zaščita	IPX4			IPX4		
RPM	2550	2360	2100	2550	2360	2100
Temperatura okolice (°C)	od +5°C do +40°C			od +5°C do +40°C		
Teža (kg)	0,37	0,42	0,52	0,42	0,49	0,61
øA (mm)	148	173	198	152	178	203
B (mm)	80	80	80	80	80	80
C (mm)	16	16	16	35	35	35
øD (mm)	99	124	149	99	124	149

AKSIALNI VENTILATORJI

EE KVADRATNI - rešetka



Barvne opcije po naročilu



Silver



Gold



Koda	EAN	Naziv	Cena
EE100	4750492006917	Aksialni ventilator EE Ø100mm	15,31
EE125	4750492006924	Aksialni ventilator EE Ø125mm	19,24
EE150	4750492006931	Aksialni ventilator EE Ø150mm	23,60
EE100T	4750492007198	Aksialni ventilator EE Ø100mm s timerjem	28,90
EE125T	4750492007303	Aksialni ventilator EE Ø125mm s timerjem	31,30
EE150T *	4750492007419	Aksialni ventilator EE Ø150mm s timerjem	36,19
EE100HT	4750492007150	Aksialni ventilator EE Ø100mms timerjem in senzorjem vlage	36,10
EE125HT	4750492007266	Aksialni ventilator EE Ø125mms timerjem in senzorjem vlage	38,53
EE150HT	4750492007372	Aksialni ventilator EE Ø150mms timerjem in senzorjem vlage	43,13

Koda	EAN	Naziv	Cena
EE100A	4750492012529	Aksialni ventilator EE Ø100mm, antracit	21,58
EE125A	4750492012550	Aksialni ventilator EE Ø125mm, antracit	24,04
EE150A	4750492012895	Aksialni ventilator EE Ø150mm, antracit	30,74



Barvne opcije po naročilu



Antracit



Silver



Gold



Inox

EET KVADRATNI - polni pokrov

Koda	EAN	Naziv	Cena
EET100	4750492008805	Aksialni ventilator EET Ø100mm	20,61
EET125	4750492008782	Aksialni ventilator EET Ø125mm	25,27
EET150	4750492008799	Aksialni ventilator EET Ø150mm	30,86
EET100T	4750492008874	Aksialni ventilator EET Ø100mm s timerjem	33,73
EET125T	4750492008881	Aksialni ventilator EET Ø125mm s timerjem	38,53
EET150T	4750492008898	Aksialni ventilator EET Ø150mm s timerjem	45,41
EET100HT	4750492009048	Aksialni ventilator EET Ø100mm s timerjem in senzorjem vlage	40,93
EET125HT	4750492009031	Aksialni ventilator EET Ø125mm s timerjem in senzorjem vlage	45,76
EET150HT	4750492009024	Aksialni ventilator EET Ø150mm s timerjem in senzorjem vlage	52,24

Tehnični podatki

	EE100	EE125	EE150	EET100	EET125	EET150
Napetost (V) / Hz	220 - 240V-50Hz			220 - 240V-50Hz		
Moč (W)	15	16	20	15	16	20
Pretok m ³ /h	100	150	200	100	150	200
Raven hrupa: 3m razdalja, Lp A dB(A)	32	36	40	32	36	40
Zaščita	IPX4			IPX4		
RPM	2550	2360	2100	2550	2360	2100
Temperatura okolice (°C)	od +5°C do +40°C			od +5°C do +40°C		
Teža (kg)	0,37	0,44	0,56	0,43	0,52	0,66
A/B (mm)	140/140	165/165	190/190	145/145	170/170	195/195
C (mm)	80	80	80	80	80	80
ØD (mm)	99	124	149	99	124	149
E (mm)	16	16	16	35	35	35

KANALSKI VENTILATORJI PVC OKROGLI KANALSKI VENTILATOR EK

Koda	EAN	Naziv	Cena
EK100	4750492006566	PVC okrogli kanalski ventilator EK Ø100mm	14,49
EK100T	4750492006573	PVC okrogli kanalski ventilator EK Ø100mm s timerjem	27,93
EK125	4750492006580	PVC okrogli kanalski ventilator EK Ø125mm	16,25
EK125T	4750492006597	PVC okrogli kanalski ventilator EK Ø125mm s timerjem	29,87
EK150	4750492006603	PVC okrogli kanalski ventilator EK Ø150mm	20,58
EK150T	4750492006610	PVC okrogli kanalski ventilator EK Ø150mm s timerjem	34,70



OKROGLI KANALSKI VENTILATOR AKM

Koda	EAN	Naziv	Cena
AKM100	4750492217467	Okrogli kanalski ventilator AK Ø100m	145,49
AKM125	4750492217474	Okrogli kanalski ventilator AK Ø125mm	147,10
AKM160	4750492217481	Okrogli kanalski ventilator AK Ø160mm	187,48



REGULATOR OBRATOV ZA OKROGLI KANALSKI VENTILATOR

Koda	EAN	Naziv	Cena
AR1.5	4750492219294	Regulator obratov za kanalski ventilator, 230V/1.5A	50,10



NEPOVRATNI VENTIL PRI VENTILATORJU

Koda	EAN	Naziv	Cena
EEV100	4750492008591	Nepovratni ventil ventilatorja Ø100mm	3,46
EEV125	4750492008607	Nepovratni ventil ventilatorja Ø125mm	4,13
EEV150	4750492008614	Nepovratni ventil ventilatorja Ø150mm	5,18



OBJEMKA ZA OKROGLI KANALSKI VENTILATOR

Koda	EAN	Naziv	Cena
MSV100	4750492219300	Objemka Ø100mm za okrogle kanalske ventilatorje	7,79
MSV125	4750492219317	Objemka Ø125mm za okrogle kanalske ventilatorje	8,67
MSV160	4750492219324	Objemka Ø160mm za okrogle kanalske ventilatorje	9,37
MSV200	4750492219331	Objemka Ø200mm za okrogle kanalske ventilatorje	10,34



Tehnični podatki

	EK100	EK125	EK150	AKM100	AKM125	AKM160
Napetost (V) / Hz	220 - 240V-50Hz			220 - 240V-50Hz		
Moč (W)	15	16	20	74	74	103
Pretok m³/h	100	150	200	379	421	866
Hitrost (vrt./min)				2800	2800	2796
Raven hrupa: 3m razdalja, Lp A dB(A)	32	36	40	58	54	57
Zaščita	IPX4			IP44		
RPM	2550	2360	2100			
Temperatura okolice (°C)	od +5°C do +40°C			od -40°C do +50°C		
Teža (kg)	0,35	0,37	0,56	3	3	4
A (mm)	99	124	149	287	287	387
B (mm)	91	91	91	244	244	344
C (mm)				189	182	217
ØD (mm)	100	125	150	100	125	160
E (mm)				152	142	166

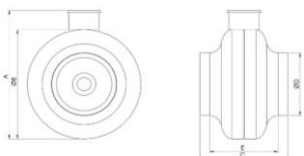
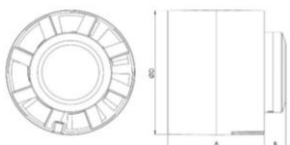

*Po naročilu

ALUMINIJASTA GIBLJIVA CEV do +250°C - 2000 Pa

Koda	EAN	Naziv	Pakiranje (kos)	Cena
G80	4750492000847	Aluminijasta gibljiva cev Ø80mm L-3m	54	8,462
G100	4750492000854	Aluminijasta gibljiva cev Ø100mm L-3m	72	9,721
G120	4750492001639	Aluminijasta gibljiva cev Ø120mm L-3m	55	12,034
G125	4750492000878	Aluminijasta gibljiva cev Ø125mm L-3m	55	12,034
G150	4750492000892	Aluminijasta gibljiva cev Ø150mm L-3m	35	14,786
G160	4750492000908	Aluminijasta gibljiva cev Ø160mm L-3m	30	24,534
G200	4750492000915	Aluminijasta gibljiva cev Ø200mm L-3m	19	19,618
G250	4750492000922	Aluminijasta gibljiva cev Ø250mm L-3m	12	24,537
G315 *	4750492000939	Aluminijasta gibljiva cev Ø315mm L-3m	6	34,375

ALUMINIJASTA GIBLJIVA CEV BELA do +250°C - 2000 Pa

Koda	EAN	Naziv	Pakiranje (kos)	Cena
G100B	4750492001684	Aluminijasta gibljiva cev bela, Ø100mm L-3m	38	19,149
G120B	4750492001707	Aluminijasta gibljiva cev bela, Ø120mm L-3m	28	23,600
G125B	4750492001721	Aluminijasta gibljiva cev bela, Ø125mm L-3m	24	23,951

POLIFLEX GIBLJIVA CEV do 80°C

Koda	EAN	Naziv	Pakiranje (kc)	Cena
FP100	4750492105429	Polyflex gibljiva cev Ø102mm L-10m	10	18,241
FP125	4750492105436	Polyflex gibljiva cev Ø127mm L-10m	12	22,926
FP160	4750492105450	Polyflex gibljiva cev Ø162mm L-10m	6	28,636
FP200	4750492105467	Polyflex gibljiva cev Ø202mm L-10m	4	38,328

IZOLIRANA CEV od -30°C do +140°C

Koda	EAN	Naziv	Pakiranje (kos)	Cena
FAT100	4750492220351	Toplotno izolirana al. cev Ø102mm, dolž.10m	1	53,846
FAT125	4750492220368	Toplotno izolirana al. cev Ø127mm, dolž.10m	1	62,425
FAT160	4750492220382	Toplotno izolirana al. cev Ø162mm, dolž.10m	1	79,612
FAT200	4750492220399	Toplotno izolirana al. cev Ø202mm, dolž.10m	1	90,241

FAS100	4750492221105	Toplotno in zvočno izolirana al. cev Ø102mm, dolžina 10m	1	53,846
FAS125	4750492221112	Toplotno in zvočno izolirana al. cev Ø127mm, dolžina 10m	1	62,425
FAS160	4750492221136	Toplotno in zvočno izolirano al. cev Ø162mm, dolžina 10m	1	79,612
FAS200	4750492221143	Toplotno in zvočno izolirano al. cev Ø202mm, dolžina 10m	1	90,241













ALUMINIJAST LEPILNI TRAK

Koda	EAN	Naziv	Pakiranje (kos)	Cena
LA50-50	4750492104781	Trak lepilni aluminij 50mm, dolžina 50m	24	11,858
LA75-50	4750492104774	Trak lepilni aluminij 75mm, dolžina 50m	16	17,656
LAS50-50	4750492104804	Trak lepilni aluminij z mrežico 50mm, dolž. 50m	24	12,180
LAS75-50	4750492105061	Trak lepilni aluminij z mrežico 75mm, dolž. 50m	16	18,212
LU48-10	4750492104491	Trak vodotesni lepilni 48mm, dolžina 10m	72	2,401
LU48-25	4750492104507	Trak vodotesni lepilni 48mm, dolžina 25m	36	4,392
LU48-50	4750492104514	Trak vodotesni lepilni 48mm, dolžina 50m	24	8,140

PVC CEVI IN PRIKLJUČKI za prezračevanje - ploščati

Koda	EAN	Naziv	Pakiranje (kos)	Cena
K-0.5	4750492102817	PVC pravokotna cev 110mm x 55mm, dolž.0,5m	20	3,953
K-1	4750492102824	PVC pravokotna cev 110mm x 55mm, dolž.1m	10	6,998
K-1.5	4750492102831	PVC pravokotna cev 110mm x 55mm, dolž.1,5m	10	10,219
K25-0.5	4750492218716	PVC pravokotna cev 220mm x 55mm, dolž.0,5m	50	7,027
K25-1	4750492218723	PVC pravokotna cev 220mm x 55mm, dolž.1m	5	13,791
K25-1.5	4750492218730	PVC pravokotna cev 220mm x 55mm, dolž.1,5m	5	20,467
K29-0.5	4750492023914	PVC pravokotna cev 220mm x 90mm, dolž.0,5m	6	9,457
K29-1	4750492023921	PVC pravokotna cev 220mm x 90mm, dolž.1m	5	18,329
K29-1.5	4750492023938	PVC pravokotna cev 220mm x 90mm, dolž.1,5m	5	27,377
KMS	4750492017074	Fleksibilna cev kvadratna 110mm x 55mm, 0,5m	10	11,302
KMS25	4750492017081	Fleksibilna cev kvadratna 220mm x 55mm, 0,5m	10	19,383
KMS29	4750492024164	Fleksibilna cev kvadratna 220mm x 90mm, 0,5m		21,404
KLK	4750492102909	PVC pravokotna cev 110mm x 55mm, dolž.0,5m	10	3,953
KLK25	4750492218655	PVC pravokotna cev 220mm x 55mm, dolž.0,5m	6	4,568
KLK29	4750492024157	PVC pravokotna cev 220mm x 90mm, dolž.0,5m	6	6,237
KLH	4750492102893	PVC horizontalno koleno 110mm x 55mm, 90°	10	2,957
KLH25-90	4750492218686	PVC horizontalno koleno 220mm x 55mm, 90°	6	6,998
KLH29-90	4750492024140	PVC horizontalno koleno 220mm x 90mm, 90°	4	10,336
KLH15-60	4750492105306	PVC horizontalno koleno 110mm x 55mm, 15°- 60°	10	2,987
KT	4750492102886	PVC T-spoj 110mm x 55mm	10	3,104
KT25	4750492218709	PVC T-spoj 220mm x 55mm	6	8,257
KT29	4750492024201	PVC T-spoj 220mm x 90mm	5	12,503
KS29-25	4750492024188	PVC adapter 220mm x 90mm / 220mm x 55mm	10	3,572
KS25-15	4750492222621	PVC priklonni reducični kanal 220mm x 55mm / 110mm x 55mm	15	3,338

PVC CEVI IN PRIKLJUČKI za prežračevanje - ploščati

Koda	EAN	Naziv	Pakiranje (kos)	Cena
 KSF	4750492007808	PVC kanalski spoj 110mm x 55mm		1,903
 KSF25	4750492007815	PVC kanalski spoj 220mm x 55mm		2,313
 KSF29	4750492024232	PVC kanalski spoj 220mm x 90mm	10	3,045
 KS	4750492102848	PVC priklonni kanal 110mm x 55mm	10	1,464
 KS25	4750492218631	PVC priklonni kanal 220mm x 55mm	10	3,162
 KS29	4750492024171	PVC priklonni kanal 220mm x 90mm	10	3,045
 KFF	4750492019016	PVC ploščati spoj 110mm x 55mm / 1 stran	10	2,518
 KFF25	4750492024058	PVC ploščati spoj 220mm x 55mm / 1 stran	10	3,782
 KFF29	4750492024065	PVC ploščati spoj 220mm x 90mm / 1 stran	10	4,392
 KFS	4750492018996	PVC ploščati spoj 110mm x 55mm / 2 strani	10	3,631
 KFS25	4750492024072	PVC ploščati spoj 220mm x 55mm / 2 strani	10	4,746
 KFS29	4750492024089	PVC ploščati spoj 220mm x 90mm / 2 strani	10	5,358
 KFV	4750492019009	PVC ploščati spoj 2 z loputo 110mm x 55mm	10	4,070
 KFV25	4750492024096	PVC ploščati spoj 2 z loputo 220mm x 55mm	10	5,795
 KFV29	4750492024102	PVC ploščati spoj 2 z loputo 220mm x 90mm	10	6,588
KV	4750492104132	PVC kanalski priključek s pokrovom 110mm x 55mm	10	1,874
KV25	4750492218648	PVC kanalski priključek s pokrovom 220mm x 55mm	10	3,836
KV29	4750492024218	PVC kanalski priključek s pokrovom 220mm x 90mm	10	3,806
KF	4750492102923	PVC ploščata zidna prirobnica 110mm x 55mm, 90°	50	1,376
KF25	4750492218624	PVC ploščata zidna prirobnica 220mm x 55mm, 90°	50	2,313
KLD	4750492102916	PVC koleno kvadratno / okroglo 110mm x 55mm, 90°	15	2,342
KLD25-100	4750492222614	PVC koleno kvadratno / okroglo 220mm x 55mm, Ø 100mm	6	5,329
KLD25-125	4750492218679	PVC koleno kvadratno / okroglo 220mm x 55mm, Ø 125mm	6	5,329
KLD29-100	4750492024119	PVC koleno kvadratno / okroglo 220mm x 90mm, Ø 100mm	6	8,813
KLD29-125	4750492024126	PVC koleno kvadratno / okroglo 220mm x 90mm, Ø 125mm	6	8,813
KLD29-150	4750492024133	PVC koleno kvadratno / okroglo 220mm x 90mm, Ø 150mm	6	8,813



PVC CEVI IN PRIKLJUČKI za prezračevanje - ploščati

Koda	EAN	Naziv	Pakiranje (kos)	Cena
KSD1	4750492102855	PVC adapter kratki kvadratni / okrogli 110mm x 55mm, Ø100mm	10	1,669
KSD2	4750492102862	PVC adapter dolgi kvadratni / okrogli 110mm x 55mm, Ø100mm	10	2,635
KSD25-125	4750492218662	PVC adapter dolgi kvadratni / okrogli 220mm x 55mm, Ø125mm	10	4,919
KSD29-150	4750492024195	PVC adapter dolgi kvadratni / okrogli 220mm x 90mm / Ø150mm	5	7,466
KZ	4750492102879	PVC spone dva kosa 110mm x 55mm	15	1,786
KZ25	4750492218617	PVC spone dva kosa 220mm x 55mm	15	2,723
KZ29	4750492024225	PVC spone dva kosa 220mm x 90mm	10	2,137

PVC CEVI IN PRIKLJUČKI za prezračevanje - okrogli

Koda	EAN	Naziv	Pakiranje (kos)	Cena
A100-0.5	4750492216453	PVC okrogla cev Ø100mm, dolžina 0,5m	12	3,631
A100-1	4750492216460	PVC okrogla cev Ø100mm, dolžina 1m	6	6,764
A100-1.5	4750492216477	PVC okrogla cev Ø100mm, dolžina 1,5m	6	9,955
A125-0.5	4750492218549	PVC okrogla cev Ø125mm, dolžina 0,5m	9	4,480
A125-1	4750492218556	PVC okrogla cev Ø125mm, dolžina 1m	4	9,311
A125-1.5	4750492218563	PVC okrogla cev Ø125mm, dolžina 1,5m	4	13,498
A150-0.5	4750492023860	PVC okrogla cev Ø150mm, dolžina 0,5m	5	7,174
A150-1	4750492023877	PVC okrogla cev Ø150mm, dolžina 1m	5	13,498
A150-1.5	4750492023884	PVC okrogla cev Ø150mm, dolžina 1,5m	5	20,028
A100T-0.3	4750492018286	PVC okrogla cev teleskopska Ø100mm, dolž. 3-5m		7,408
A125T-0.3	4750492018293	PVC okrogla cev teleskopska Ø125mm, dolž. 3-5m		10,219
A150T-0.3	4750492023891	PVC okrogla cev teleskopska Ø150mm, dolž. 3-5m		9,370
AMS100	4750492017050	Fleksibilna cev okrogla Ø100mm, dolžina 0,5m	10	9,457
AMS125	4750492017067	Fleksibilna cev okrogla Ø125mm, dolžina 0,5m	10	11,039
AMS150	4750492023990	Fleksibilna cev okrogla Ø150mm, dolžina 0,5m	10	13,732
AZ100	4750492216484	PVC okroglo držalo Ø100mm 2 kosa	10	1,903
AZ125	4750492218587	PVC okroglo držalo Ø125mm 2 kosa	10	2,723
AZ150	4750492024041	PVC okroglo držalo Ø150mm 2 kosa	10	2,430



PVC CEVI IN PRIKLJUČKI za prezračevanje - okrogli

Koda	EAN	Naziv	Pakiranje (kos)	Cena
AS100	4750492211953	PVC priklopni kanal okrogli Ø100mm	10	1,698
AS125	4750492211960	PVC priklopni kanal okrogli Ø125mm	10	1,903
AS150	4750492024010	PVC priklopni kanal okrogli Ø150mm	10	2,577
ASF100	4750492007822	PVC spojka okrogla Ø100mm	10	3,045
ASF125	4750492007839	PVC spojka okrogla Ø125mm	10	3,045
ASF150	4750492023907	PVC spojka okrogla Ø150mm	10	3,045
AT100	4750492211977	PVC T-kos Ø100mm / Ø100mm	15	3,719
AT125	4750492211984	PVC T-kos Ø125mm / Ø125mm	5	6,676
AT150	4750492024027	PVC T-kos Ø150mm / Ø150mm	4	10,746
AL100-45	4750492005224	PVC koleno Ø100mm / 45°	4	2,869
AL125-45	4750492023969	PVC koleno Ø125mm / 45°	4	5,124
AL150-45	4750492023976	PVC koleno Ø150mm / 45°	4	6,120
AL100-90	4750492216491	PVC koleno Ø100mm / 90°	15	2,869
AL125-90	4750492218570	PVC koleno Ø125mm / 90°	6	5,124
AL150-90	4750492023983	PVC koleno Ø150mm / 90°	6	7,818
AFS100	4750492211946	PVC stenski priključek Ø100mm	10	2,137
AFS125	4750492211939	PVC stenski priključek Ø125mm	10	2,782
AFS150	4750492023945	PVC stenski priključek Ø150mm	10	3,279
AFV100	4750492212004	PVC stenski priključek z loputo Ø100mm	10	2,694
AFV125	4750492211991	PVC stenski priključek z loputo Ø125mm	10	3,338
AFV150	4750492023952	PVC stenski priključek z loputo Ø150mm	10	4,041
AV100	4750492211977	PVC priklopni kanal z loputo Ø100mm	10	1,991
AV125	4750492211984	PVC priklopni kanal z loputo Ø125mm	10	2,518
AV150	4750492024034	PVC priklopni kanal z loputo Ø150mm	10	3,279
AP125-100	4750492222607	PVC prehodni kos 125/100mm	6	3,162
AP150-125	4750492024003	PVC prehodni kos 150/125mm	6	3,953
VA80	4750492102930	PVC stopenjska reducirka 80-100-120-125-150mm	10	2,342



*Po naročilu

PVC CEVI IN PRIKLJUČKI za prezračevanje - okrogli

Koda	EAN	Naziv	Pakiranje (kos)	Cena
VA90	4750492000748	PVC prehod kvadratni/okrogli 90mm x 90mm / Ø100mm	12	1,874
VA91	4750492103999	PVC prehod kvadratni/okrogli 100mm x 100mm / Ø100mm	12	1,874
VF100	4750492001592	PVC podaljšek za PV ventil Ø100mm	10	1,991
VF125	4750492001608	PVC podaljšek za PV ventil Ø125mm	10	1,991
VF150	4750492001615	PVC podaljšek za PV ventil Ø150mm	10	2,460
VA100	4750492000267	PVC adapter 160mm x 250mm Ø100mm	10	2,811
VA120	4750492210437	PVC adapter 160mm x 250mm Ø120mm	10	2,811
VA125	4750492000274	PVC adapter 160mm x 250mm Ø125mm	10	2,957
VA150	4750492000441	PVC adapter 190mm x 250mm Ø150mm	10	3,601
NA10	4750492104316	PVC rešetka priključek 250mm x 180mm Ø100mm s prirobnico	10	3,543

KOVINSKI ZRAČNI VENTILI

Koda	EAN	Naziv	Pakiranje (kos)	Cena
DM80	4750492000571	Odvodni kovinski zračni ventil Ø80mm	10	4,626
DM100	4750492000588	Odvodni kovinski zračni ventil Ø100mm	10	5,065
DM125	4750492000595	Odvodni kovinski zračni ventil Ø125mm	10	6,822
DM150	4750492000601	Odvodni kovinski zračni ventil Ø150mm	10	9,780
DMP80	4750492000632	Dovodni kovinski zračni ventil Ø80mm	10	4,626
DMP100	4750492000649	Dovodni kovinski zračni ventil Ø100mm	10	5,065
DMP125	4750492000656	Dovodni kovinski zračni ventil Ø125mm	10	6,822
DMP150	4750492000663	Dovodni kovinski zračni ventil Ø150mm	10	9,780
DMKP100 *	4750492013274	Kovinski zračni ventil Ø100mm	10	10,014
DMKP125	4750492013281	Kovinski zračni ventil Ø125mm	10	13,410
DMKP160 *	4750492013298	Kovinski zračni ventil Ø160mm	10	18,388

PVC ZRAČNI VENTILI

Koda	EAN	Naziv	Pakiranje (kos)	Cena
VD100	4750492000113	PV ventil Ø100mm	10	5,944
VD125	4750492000120	PV ventil Ø125mm	10	7,349
VD150	4750492000137	PV ventil Ø150mm	10	8,491
VDA100	4750492000168	PV ventil z vzmetjo Ø100mm	10	6,822
VDA125	4750492000182	PV ventil z vzmetjo Ø125mm	10	7,554
VDA150-160	4750492000144	PV ventil z vzmetjo Ø150-160mm	10	
KD100 *	4750492000519	Leseni ventil Ø100mm	10	13,586
KD125	4750492000526	Leseni ventil Ø125mm	10	15,431
KD160	4750492000533	Leseni ventil Ø160mm	10	16,192
NGA100	4750492106099	PVC rešetka stropna okrogla Ø100mm	10	3,396
NGA125	4750492106105	PVC rešetka stropna okrogla Ø125mm	10	3,924
NGA150	4750492106112	PVC rešetka stropna okrogla Ø150mm	10	4,333

*Po naročilu

PVC REŠETKE

Koda	EAN	Naziv	Pakiranje (kos)	Cena
ND10FV	4750492011300	PVC zidna rešetka s protipovratno loputo bela, 148 x 153mm, ø100	10	5,153
ND12FV	4750492011348	PVC zidna rešetka s protipovratno loputo bela, 190 x 190mm, ø125	10	5,885
ND15FV	4750492011386	PVC zidna rešetka s protipovratno loputo bela, 190 x 190mm, ø150	10	5,885
N10	4750492000281	PVC fiksna rešetka 148mm x 153mm,	10	3,396
N12	4750492000755	PVC fiksna rešetka 190mm x 190mm	10	3,924
ND10	4750492000304	PVC fiksna rešetka 148mm x 153mm, s prirobnico Ø100mm	10	3,396
ND12	4750492000762	PVC fiksna rešetka 190mm x 190mm, s prirobnico Ø125mm	10	3,924
ND15	4750492000816	PVC fiksna rešetka 190mm x 190mm, s prirobnico Ø150mm	10	3,924
N10R	4750492000298	PVC rešetka regulacijska 148mm x 153mm	10	4,128
N12R	4750492000793	PVC rešetka regulacijska 190mm x 190mm	10	4,890
ND10R	4750492000311	PVC rešetka regulacijska 148mm x 153mm, s prirobnico Ø100mm	10	4,128
ND12R	4750492000779	PVC rešetka regulacijska 190mm x 190mm, s prirobnico Ø125mm	10	4,890
ND15R	4750492000823	PVC rešetka regulacijska 190mm x 190mm, s prirobnico Ø150mm	10	4,890
N10A	4750492011577	PVC rešetka pravokotna 150mm x 150mm, antracit	10	7,701
N12A	4750492011591	PVC rešetka pravokotna 190mm x 190mm, antracit	10	10,453
N10G	4750492218433	PVC rešetka stropna kvadratna 148mm x 153mm, Ø100mm	10	3,396
N12G	4750492218457	PVC rešetka stropna kvadratna 190mm x 190mm, Ø125mm	10	3,924
ND10GR	4750492218488	PVC rešetka stropna kvadratna 150mm x 150mm, regulacijska, Ø125mm	10	4,128
ND12GR	4750492218501	PVC rešetka stropna kvadratna 190mm x 190mm, regulacijska, Ø125mm	10	4,890
ND15GR	4750492218525	PVC rešetka stropna kvadratna 190mm x 190mm, regulacijska, Ø150mm	10	4,890
N10Z	4750492000960	PVC nihajna rešetka 148mm x 153mm Ø100mm	10	3,396
N12Z	4750492000953	PVC nihajna rešetka 190mm x 190mm Ø125mm	10	3,924
ND10Z	4750492000328	PVC nihajna rešetka 148mm x 153mm Ø100mm s prirobnico	10	3,396
ND12Z	4750492000786	PVC nihajna rešetka 190mm x 190mm Ø125mm s prirobnico	10	3,924
ND15Z	4750492000830	PVC nihajna rešetka 190mm x 190mm Ø150mm s prirobnico	10	3,924

*Po naročilu

PVC REŠETKE

Koda	EAN	Naziv	Pakiranje (kos)	Cena
N25	4750492000359	PVC rešetka pravokotna 170mm x 250mm	10	3,689
N30	4750492000335	PVC rešetka pravokotna 140mm x 300mm	10	3,689
N25R	4750492000366	PVC rešetka pravokotna regulacijska 170mm x 250mm	10	5,065



HR1515	4750492219096	PVC rešetka s filtrom 150mm x 150mm	6	8,843
HR2020	4750492219119	PVC rešetka s filtrom 200mm x 200mm	6	11,361
HR2030 *	4750492219133	PVC rešetka s filtrom 200mm x 300mm	6	15,021
HR3030	4750492219140	PVC rešetka s filtrom 300mm x 300mm	6	22,282
HR4030 *	4750492219157	PVC rešetka s filtrom 300mm x 400mm	6	18,476
HR4040	4750492219164	PVC rešetka s filtrom 400mm x 400mm	6	32,032

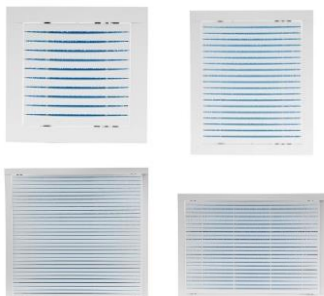

VR1515	4750492000083	PVC rešetka kvadratna 150mm x 150mm	10	1,610
VR2525	4750492000069	PVC rešetka kvadratna 250mm x 250mm	10	3,543
VR1330	4750492000021	PVC rešetka pravokotna 130mm x 300mm	10	2,255
VR2517 *	4750492000045	PVC rešetka pravokotna 250mm x 170mm	10	2,313

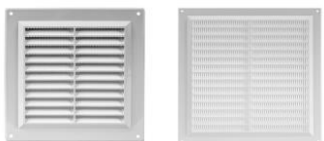

VR459	4750492000106	PVC rešetka pravokotna 450mm x 92mm	15	5,007
--------------	---------------	-------------------------------------	----	--------------



VR100	4750492000243	PVC okrogla rešetka Ø100mm	10	1,552
VR125	4750492000250	PVC okrogla rešetka Ø125mm	10	1,845
VR150	4750492010143	PVC okrogla rešetka Ø150mm	10	2,313



REŠETKE ALUMINIJASTE

Koda	EAN	Naziv	Pakiranje (kos)	Cena
MRA80	4750492104330	Zunanja aluminijasta stenska rešetka Ø80mm	10	10,189
MRA100	4750492104347	Zunanja aluminijasta stenska rešetka Ø100mm	10	5,270
MRA125	4750492104354	Zunanja aluminijasta stenska rešetka Ø125mm	10	6,764
MRA160	4750492104361	Zunanja aluminijasta stenska rešetka Ø160mm	10	10,716
MRA200	4750492104378	Zunanja aluminijasta stenska rešetka Ø200mm	8	15,548
MRA250	4750492104385	Zunanja aluminijasta stenska rešetka Ø250mm	8	28,343
MRA315	4750492104392	Zunanja aluminijasta stenska rešetka Ø315mm	8	47,492

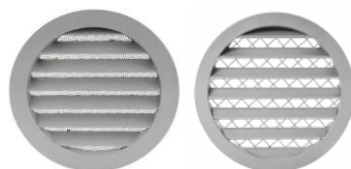

REŠETKE ALUMINIJASTE VENTILACIJSKE

Koda	EAN	Naziv	Pakiranje (kos)	Cena
RA430S	4750492220801	Rešetka aluminijasta ventilacijska 40 x 300mm, silver	40	6,529
RA640	475092222256	Rešetka aluminijasta ventilacijska 60 x 300mm, bela	40	7,759
RA650S	4750492220955	Rešetka aluminijasta ventilacijska 60 x 500mm, silver	70	8,725
RA850S	4750492221013	Rešetka aluminijasta ventilacijska 80 x 500mm, silver	60	9,926











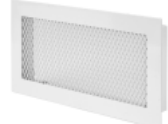

*Po naročilu

REŠETKE BARVANA PLOČEVINA

Koda	EAN	Naziv	Pakiranje (kos)	Cena
 	MR1010	4750492000373	Pločevinasta rešetka 100 x 100mm, bela	15 4,948
	MR1010ZN	4750492001486	Pločevinasta rešetka 100 x 100mm, cink	15 4,275
	MR100	4750492000458	Zunanja stenska rešetka bela Ø100mm	15 3,836
	MR125	4750492000465	Zunanja stenska rešetka bela Ø125mm	15 4,451
 	MR160	4750492000472	Zunanja stenska rešetka bela Ø160mm	15 6,032
	MR200	4750492000489	Zunanja stenska rešetka bela Ø200mm	15 8,316
	MR2619	4750492000199	Pločevinasta rešetka 260 x 190mm, regul., bela	15 7,349
				0,000
 	MR3010	4750492000229	Pločevinasta rešetka 300 x 100mm, bela	10 7,379
	MR5010	4750492104255	Pločevinasta rešetka 500 x 100mm, bela	15 10,453
	MR4010R	4750492000502	Pločevinasta rešetka 400 x 100mm, regul., bela	10 12,005

REŠETKE ZA KAMINE

Koda	EAN	Naziv	Pakiranje (kos)	Cena
 	MRK1515	4750492103012	Rešetka za kamin 150mm x 150mm	5 20,408
	MRK1515A *	4750492212806	Rešetka za kamin 150mm x 150mm, patinirana	5 26,528
	MRK1810	4750492104521	Rešetka za kamin 180mm x 100mm	10 19,003
	MRK1810A *	4750492212837	Rešetka za kamin 180mm x 100mm, patinirana	10 12,561
	MRK1818 *	4750492102978	Rešetka za kamin 180mm x 180mm	5 24,449
 	MRK1818A	4750492212851	Rešetka za kamin 180mm x 180mm, patinirana	5 16,145
	MRK2512	4750492104538	Rešetka za kamin 250mm x 120mm	8 24,449
	MRK2512A *	4750492212882	Rešetka za kamin 250mm x 120mm, patinirana	8 31,769
	MRK3015 *	4750492102947	Rešetka za kamin 300mm x 150mm	8 40,758
	MRK4018A	4750492212943	Rešetka za kamin 400mm x 180mm, patinirana	8 35,821
 	MRK2512S *	4750492104569	Kaminska rešetka z okvirjem in sitom 250mm x 120mm	8 20,379
	MRK3015S *	4750492102954	Kaminska rešetka z okvirjem in sitom 300mm x 150mm	6 30,937
	MRK4018S *	4750492106709	Kaminska rešetka z okvirjem in sitom 400mm x 180mm	8 40,723
 	MRK1515R	4750492103036	Nastavljiva rešetka za kamine 150mm x 150mm	5 46,145
	MRK1818R	4750492102992	Nastavljiva rešetka za kamine 180mm x 180mm	4 48,868
	MRK1818RA *	4750492202875	Nastavljiva rešetka za kamine 180mm x 180mm, patinirana	4 32,255
	MRK2512	4750492104538	Nastavljiva rešetka za kamine 250mm x 120mm	8 24,449
	MRK2512R	4750492104552	Nastavljiva rešetka za kamine 250mm x 120mm, patinirana	8 47,463
	MRK2512RA	4750492212905	Nastavljiva rešetka za kamine 250mm x 120mm, patinirana	8 52,265
	MRK3015R *	4750492102961	Nastavljiva rešetka za kamine 300mm x 150mm	6 65,177
	MRK3015RA *	4750492212936	Nastavljiva rešetka za kamine 300mm x 150mm, patinirana	6 43,006

VGRADNA VRATCA

Koda	EAN	Naziv	Pakiranje	Cena
PL1515	4750492105078	PVC vgradna vratca 150mm x 150mm	6	3,455
PL1520	4750492210444	PVC vgradna vratca 150mm x 200mm	6	4,304
PL2020	4750492105092	PVC vgradna vratca 200mm x 200mm	6	5,241
PL2025	4750492105108	PVC vgradna vratca 200mm x 250mm	6	6,090
PL2030	4750492105115	PVC vgradna vratca 200mm x 300mm	6	7,701
PL3030	4750492105122	PVC vgradna vratca 300mm x 300mm	6	8,462
PL4030	4750492219171	PVC vgradna vratca 400mm x 300mm	6	12,620
PL4040	4750492219188	PVC vgradna vratca 400mm x 400mm	6	16,338
RL1515	4750492010044	Pločevinasta vgradna vratca 150mm x 150mm, zunanja	5	11,829
RL2020	4750492100011	Pločevinasta vgradna vratca 200mm x 200mm, zunanja	5	14,172
RL2025	4750492010068	Pločevinasta vgradna vratca 200mm x 250mm, zunanja	5	15,050
RL2030	4750492100028	Pločevinasta vgradna vratca 200mm x 300mm, zunanja	5	16,397
RL3030	4750492100035	Pločevinasta vgradna vratca 300mm x 300mm, zunanja	5	18,593
RL3040	4750492010051	Pločevinasta vgradna vratca 300mm x 400mm, zunanja	5	22,780
RL4040	4750492010075	Pločevinasta vgradna vratca 400mm x 400mm, zunanja	5	27,582
RL4050	4750492102602	Pločevinasta vgradna vratca 400mm x 500mm, zunanja	5	30,598
RL5050	4750492010235	Pločevinasta vgradna vratca 500mm x 500mm, zunanja	5	37,537
RL6040	4750492010259	Pločevinasta vgradna vratca 600mm x 400mm, zunanja	5	37,537
RLM1515	4750492102619	Pločevinasta revizijska vratca 150mm x 150mm	6	9,282
RLM2015	4750492102626	Pločevinasta revizijska vratca 200mm x 150mm	6	10,043
RLM2020	4750492102633	Pločevinasta revizijska vratca 200mm x 200mm	6	10,365
RLM3030	4750492102664	Pločevinasta revizijska vratca 300mm x 300mm	6	14,406
RLM4050	4750492107287	Pločevinasta revizijska vratca 400mm x 400mm	6	26,498
RLM5050	4750492107300	Pločevinasta revizijska vratca 500mm x 500mm	6	31,476
RLA2020	4750492010167	Pločevinasta vgradna vratca s ključavnico 200mm x 200mm, zunanja	5	18,622
RLA3030	4750492010174	Pločevinasta vgradna vratca s ključavnico 300mm x 300mm, zunanja	5	23,190
RLA3040	4750492102770	Pločevinasta vgradna vratca s ključavnico 300mm x 400mm, zunanja	5	27,348
RLA4040	4750492102787	Pločevinasta vgradna vratca s ključavnico 400mm x 400mm, zunanja	5	32,676
RLA5050	4750492010082	Pločevinasta vgradna vratca s ključavnico 500mm x 500mm, zunanja	5	43,422
RLA6040	4750492010181	Pločevinasta vgradna vratca s ključavnico 600mm x 400mm, zunanja	5	43,422
RLA6060	4750492010099	Pločevinasta vgradna vratca s ključavnico 600mm x 600mm, zunanja	5	45,799
RLMA1515	4750492102671	Pločevinasta vgradna vratca s ključavnico 150mm x 150mm	6	15,543
RLMA2020	4750492102695	Pločevinasta vgradna vratca s ključavnico 200mm x 200mm	6	16,719
RLMA3030	4750492102725	Pločevinasta vgradna vratca s ključavnico 300mm x 300mm	6	21,228
RLMA3040	4750492107331	Pločevinasta vgradna vratca s ključavnico 300mm x 400mm	6	26,498
RLMA4040	4750492107348	Pločevinasta vgradna vratca s ključavnico 400mm x 400mm	6	29,514
MDU2020	4750492006191	Pločevinasta maskirna vratca za keramiko 200mm x 200mm	6	12,854
MDU2030	4750492006207	Pločevinasta maskirna vratca za keramiko 200mm x 300mm	6	15,255
MDU2535	4750492006214	Pločevinasta maskirna vratca za keramiko 250mm x 350mm	6	16,075
MDU5020	4750492006221	Pločevinasta maskirna vratca za keramiko 500mm x 200mm	6	19,588
RLR2020	4750492219881	Revizijska vratca za mavčne plošče 200mm x 200mm	5	30,451
RLR3030	4750492219898	Revizijska vratca za mavčne plošče 300mm x 300mm	5	36,659
RLR4040	4750492219904	Revizijska vratca za mavčne plošče 400mm x 400mm	5	41,343
RLR6060	4750492219928	Revizijska vratca za mavčne plošče 600mm x 600mm	5	55,778

STENSKA KLIMATSKA NAPRAVA XTREME SAVE, Wi-fi, BREEZE AWAY FUNKCIJA - set



Koda	Model	Hlajenje (kW)	Ogrevanje (kW)	Energijski razred	(S)EER / (S)COP	Področje delovanja hl./ogr. (°C)	Premer cevi tekoča / plinska faza	Max.dolž.inštalacij / max.višinska razlika(m)	Cena seta	
20101726	MSAGAU-09HRFNX-QRD0GW	2,6	2,9	A++ / A+	7,4 / 4,1	-15-50/-15-30	1/4" / 3/8"	25 / 10m	562,22	
20101727	MOX102-09HFN8-QRD0GW	zunanja enota								
20101407	MSAGBU-12HRFNX-QRD0GW	3,5	3,8	A++ / A+	7,0 / 4,2	-15-50/-15-30	1/4" / 3/8"	25 / 10m	574,23	
20101408	MOX102-12HFN8-QRD0GW	zunanja enota								

NOTRANJE ENOTE - STENSKE



Koda	Model	Hlajenje (kW)	Ogrevanje (kW)	Cena
20101726	MSAGAU-09HRFNX-QRD0GW	2,6	2,9	Wi-fi Breeze away funkcija 206,08
20101401	MSAGBU-12HRFNX-QRD0GW	3,5	3,8	Wi-fi Breeze away funkcija 216,09
	MSAGCU-18HRFNX-QRD0GW	5,27	5,6	Wi-fi Breeze away funkcija 350,14

MULTIZUNANJE ENOTE



Koda	Model	Povezuje	Hlajenje (kW)	Ogrevanje (kW)	Energijski razred	(S)EER / (S)COP	Področje delovanja hl./ogr. (°C)	Premer cevi tekoča / plinska faza	Max.dolž.inštalacij / max.višinska razlika (m)	Cena
20101570	M2OE-18FN8-Q	do 2 notranji enoti, el.grelec	5,3	5,6	A++ / A+	6,3 / 4,0	-15-50/-15-24	1/4" / 3/8"	40 / 15m	940,38
	M3OG-21HFN8-Q	do 3 notranje enote, el.grelec	6,1	6,6	A++ / A+	6,1 / 4,0	-15-50/-15-24	1/4" / 3/8"	60 / 15m	1.120,45
20101574	M3OA-27FN8-Q	do 3 notranje enote, el.grelec	7,9	8,2	A++ / A+	4,1 / 4,0	-15-50/-15-24	1/4" / 3/8"	60 / 15m	1.300,52
	M4OG-28FN8-Q	do 4 notranje enote, el.grelec	8,2	8,8	A++ / A+	6,5 / 4,0	-15-50/-15-24	1/4" / 3/8"	80 / 15m	1.520,61
20101547	M4OG-36FN8-Q	do 4 notranje enote, el.grelec	10,55	10,55	A++ / A+	6,5 / 4,0	-15-50/-15-24	1/4" / 3/8"	80 / 10 (15)m	2.200,88

STROPNE NOTRANJE ENOTE - KASETE



Koda	Model	Hlajenje (kW)	Ogrevanje (kW)	Cena
20273400	MCA3U-12HRFNX-QRD0W (GA)	3,5	4,1	Brezžični + žični daljinec 470,19
	MCA3U-18HRFNX-QRD0W (GA)	5,3	5,6	Brezžični + žični daljinec 498,20

STROPNE NOTRANJE ENOTE - KASETNE GARNITURE

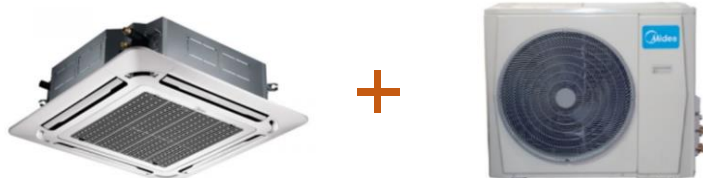

Koda	Model	Hlajenje (kW)	Ogrevanje (kW)	Cena seta
20723400	MCA3U-12HRFNX-QRD0W (GA)	3,5	4,1	notranja enota Brezžični + žični daljinec 1.368,47
20723425	MOX230-12HFN8-QRD0W (GA)	zunanja enota		

AIR-SERNET RAZMAŠČEVALEC ZA ČIŠČENJE OGREVALNIH IN KLIMA NAPRAV



Koda	Volumen (l)	Cena
10199505	5	64,07
EAN:	8436042510139	
10199501	1	13,45

EAN:

Nekislinsko čistilo za čiščenje in vzdrževanje vseh vrst klimatskih in ogrevalnih naprav, za izboljšanje in povečanje učinkovitosti. Odpravlja ostanke in usedline prahu, maščob, olj, ki se lahko pojavijo pri ogrevanju, prezračevanju in klimatizaciji v hladilni industriji. Lahko ga razredčimo z vodo.

AIRNET DEZINFIKATOR BAKTERICID ZA PRAZRAČEVALNE / HLADILNE SISTEME



Koda	Volumen (l)	Cena
10262550	5	77,00
EAN:	8436042510382	
10262501	0,75	17,41

EAN:

Dezinfikator / baktericid / fungicid je namenjen čiščenju in razkuževanju opreme in instalacij prezračevanja in hlajenja v prehranski industriji. Odstranjuje vse vrste umazanije in oblog, ki nastanejo pri pretoku zraka (mikroorganizme, bakterije, nikotin, prah) brez drgnjenja.

AIRPUR ODSTRANJEVALEC VONJAV ZA PRAZRAČEVALNE / HLADILNE SISTEME



Koda	Volumen (l)	Cena
10261050	5	116,49
EAN:		
10261001	0,75	20,75
EAN:	8436042510351	

Za odstranjevanje vonjav po čiščenju in razkuževanju opreme in instalacij prezračevanja in hlajenja z AIRNET čistilom v prehranski industriji. Ne uporabljajte v bližini hrane.

AIR GASLEAK SPREJ DETEKTOR UHAJANJA PLINA



Koda	Volumen (l)	Cena
10332601	0,75	14,75
EAN:	8436042510580	
10332501	0,4	15,70
EAN:		

Detektor dimnih plinov in komprimiranega zraka v spreju. Pokaže tesnost spojev, ventilov, fittingov, regulatorjev in gibljivih cevi na napeljavah. Ni vnetljiv in je primeren za plinske napeljave. Je viskozen in primeren za nanos na različne površine. Vsebuje fluorescentno rdečilo za boljšo vidljivost. Mehurčki pokažejo mesto uhajanja plina.

SOLARTECH CLEAN ČISTILO ZA SOLARNE IN FOTOVOLTAIČNE PANELE



Koda	Volumen (l)	Cena
10266005	5	67,88
EAN:		
10266001	0,75	19,54
EAN:	8436042511044	

Za čiščenje vseh površin v solarnem in fotovoltaičnem sistemu. Nanos s pršenjem, po 5 minutah splakniti brez drgnjenja. Ustvari zaščitni sloj proti oblogam umazanije in vodnega kamna. Ne pušča sledi na gumi, plastiki in aluminiju. Biorazgradljivo.

AIR FIRE ZAŠČITNI SPREJ ZA VARJENJE



Koda	Volumen (l)	Cena
103160	0,75	19,68
EAN:	8436042510092	

Za zaščito površin pred visokimi temperaturami pri varjenju. Odbija vročino, prepreči opekline, poškodbe in druge neželjene učinke visokih temperatur. Z izhlapevanjem absorbira vročino na občutljivih površinah, npr. lesu, ploščicah, aluminiju, steklu, plastiki, gumi, fugah, pipah...

AQ FORTE PLUS KONCENTRIRANI ODMAŠEVALEC ODTOKOV



Koda	Volumen (l)	Cena
10286001	1	13,12
EAN:	8436042510696	

Visoko koncentrirana žveplova kislina (98%) za popolno razgrajevanje organskih snovi (papir, ostanke hrane, krpe, cigaretni ogorki, sanitarne brisače, celuloza, maščobne obloge, lasje) brez korozivnega učinka na odtočno napeljavo, razen reaktivnih kovin, aluminija. Povzroča potemnitev nerjavečega jekla.



CREMAN PASTA ZA UMIVANJE ROK



Koda	Teža (kg)	Cena
10171201	1	12,13
EAN:	8436042510078	

Pasta za umivanje rok z učinkovitimi trdnimi delci v kremnem milu, ki olajšajo čiščenje. Nanesite na suhe roke, zdrgnite umazanijo in dobro sperite z vodo.



en vijak

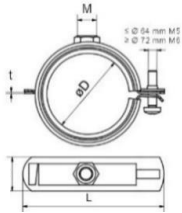

CEVNA OBJEMKA GUMIRANA en vijak

Koda	EAN	Navoj	Dimenzije (mm)	Premer (mm)	Pakiranje (kos)	Cena
3X1001216	8595609118833	M8/M10	1/4"	12-16	100	0,86
3X1001719	8595609118840	M8/M10	3/8"	17-19	100	0,92
3X1002023	8595609118857	M8/M10	1/2"	20-23	100	0,97
3X1002530	8595609118864	M8/M10	3/4"	25-30	100	1,01
3X1003138	8595609118871	M8/M10	1"	31-38	100	1,08
3X1004046	8595609118888	M8/M10	5/4"	40-46	100	1,15
3X1004853	8595609118895	M8/M10	6/4"	48-53	50	1,31
3X1006064	8595609118901	M8/M10	2"	60-64	50	1,48



dva vijaka

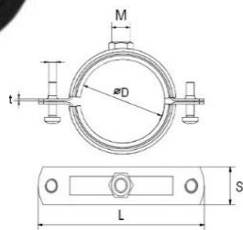

CEVNA OBJEMKA GUMIRANA dva vijaka

Koda	EAN	Navoj	Dimenzije (mm)	Premer (mm)	Pakiranje (kos)	Cena
312007278	8595609101347	M8/M10	2 1/2"	72-78	50	2,60
312008792	8595609101361	M8/M10	3"	87-92	50	2,93
312102116	8595609101385	M8/M10	4"	102-116	50	3,43
312121127	8595609101415	M8/M10	4 1/2"	121-127	25	4,81
312133141	8595609101422	M8/M10	5"	133-141	25	4,95
312159168	8595609101439	M8/M10	6"	159-168	25	5,55
312210219	8595609101484	M8/M10	8"	210-219	12	6,52



dva vijaka

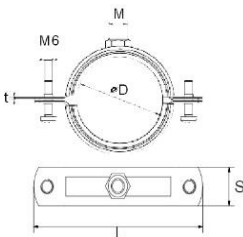

GUMI OBJEMKA – INOX dva vijaka

Koda	EAN	Navoj	Dimenzije (mm)	Premer (mm)	Pakiranje (kos)	Cena
315001719	8595609102443	M8	10 (3/8")	17-19	100	4,02
315002023	8595609102450	M8	15 (1/2")	20-23	100	4,02
315002530	8595609102467	M8	20 (3/4")	25-30	100	4,16
315003138	8595609102474	M8	25 (1")	31-38	100	4,29
315004046	8595609102481	M8	32 (5/4")	40-46	100	4,51
315004853	8595609102498	M8	40 (6/4")	48-53	50	4,63
315006064	8595609102511	M8	50 (2")	60-64	50	5,41
315007278	8595609102542	M10	65 (2 1/2")	72-78	50	6,60
315008792*	8595609102566	M10	75 (3")	87-92	50	7,36
315101106*	8595609102634	M10	100 (4")	102-116	50	11,65
315101121*	8595609102658	M10	115 (4 1/2")	121-127	25	12,79
315101133*	8595609102665	M10	125 (5")	133-141	25	13,36
315101159*	8595609102672	M10	150 (6")	159-168	25	14,74

GUMI OBJEMKE ZA PREZRAČEVANJE dvojne

Koda	EAN	Navoj	Dimenzije (mm)	Premer (mm)	Nosilnost (N)	Pakiranje (kos)	Cena
318000100	8595609105307	M8/M10	150 x 25 x 1,5	100	600	25	3,39
318000140	8595609105338	M8/M10	190 x 25 x 1,5	140	600	25	4,60
318000160	8595609105352	M8/M10	210 x 25 x 1,5	160	600	25	5,14
318000180	8595609105369	M8/M10	230 x 25 x 1,5	180	600	25	5,27
318000200	8595609105376	M8/M10	250 x 25 x 1,5	200	600	25	6,17
318000250	8595609105406	M8/M10	250 x 25 x 2	250	600	25	7,86

GUMI OBJEMKE MASIV UNI z univerzalno matico, zvočno izolacijo

Koda	EAN	Navoj	Dimenzije (mm)	Premer (mm)	Pakiranje (kos)	Cena
317000064*	8595609103365	M12/M16	149 x 40 x 4	60-64	1	3,06
317000071*	8595609103372	M12/M17	157 x 40 x 4	67-71	1	3,07

*odprodaja!

GUMI OBJEMKE MASIV dvojne

Koda	EAN	Navoj	Dimenzije (mm)	Premer (mm)	Pakiranje (kos)	Cena
317108118	8595609103815	M12	210 x 40 x 4	108-118	1	14,39
317108125	8595609103822	M12	227 x 40 x 4	125-130	1	15,00
317133137	8595609103839	M13	228 x 40 x 4	133-137	1	16,33

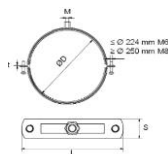



CEVNO DRŽALO GUMIRANO DVOJNO Z VIJAKOM M8

Koda	EAN	Navoj	Dimenzije (mm)	Razmik (mm)	Pakiranje (kos)	Cena
314800015	8595609102375	M8	2 x 15	46	50	2,37
314800018	8595609102382	M8	2 x 18	48	50	2,50
314800022	8595609102399	M8	2 x 22	50	50	2,62
314800028	8595609102405	M8	2 x 28	56	50	2,76

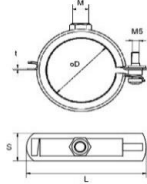

CEVNE GUMIRANE DRSNE OBJEMKE za PVC cevi - en vijak

Koda	EAN	Navoj	Dimenzije (mm)	Premer (mm)	Pakiranje (kos)	Cena
313002023	8595609101941	M8	15 (1/2")	20-23	100	1,29
313002530	8595609101958	M8	20 (3/4")	25-30	100	1,31
313003138	8595609101965	M8	25 (1")	31-38	100	1,45

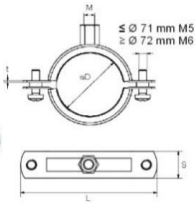

CEVNE GUMIRANE DRSNE OBJEMKE za PVC cevi - dva vijaka

Koda	EAN	Navoj	Dimenzije (mm)	Premer (mm)	Pakiranje (kos)	Cena
313007278	8595609102023	M8/M10	65 (2 1/2")	72-78	50	3,32

CEVNA OBJEMKA rebričasta

Koda	EAN	Širina (mm)	Premer (mm)	Pakiranje (kos)	Cena
390001016	8595609116792	9	10-16	25	0,60
390001220	8595609116808	9	12-20	25	0,51
390001625	8595609116815	9	16-25	25	0,53
390002032	8595609116822	9	20-32	25	0,56
390005070	8595609116860	9	50-70	25	0,79
390010012	8595609116914	9	100-120	10	1,36
390011013	8595609116921	9	110-130	10	1,47
390014016	8595609116952	9	140-160	10	1,88
390101220	8595609116990	9	12-22	10	0,77
390101625	8595609117003	9	16-27	25	0,78
390102032	8595609117010	9	20-32	25	0,80



CEVNA OBJEMKA – BREZ GUME dva vijaka

Koda	EAN	Navoj	Dimenzije (mm)	Premer (mm)	Nosilnost (N)	Pakiranje (kos)	Cena
314001216	8595609102153	M8	20 (3/4")	22-28	800	100	0,62
314002023	8595609102177	M8	25 (1")	32-35	800	100	0,73
314002530	8595609102184	M8	32 (5/4")	37-42	800	100	0,94
314003138	8595609102191	M8	40 (6/4")	43-50	800	100	0,78
314004853	8595609102214	M8	50 (2")	60-65	2100	50	0,92

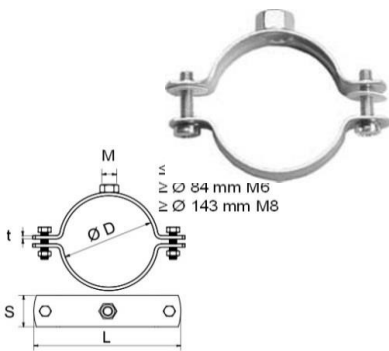

STENSKA KONZOLA pocinkano jeklo

Koda	EAN	Dolžina (mm)	Dimenzije (mm)	Dim.plošče (mm)	Pakiranje (kos)	Cena
332271820	8595609110424	200	27/18x1,25	120x40x4	20	5,33
332271830	8595609110455	300	27/18x1,25	120x40x4	20	6,20
332271850	8595609110509	500	27/18x1,25	120x40x4	10	8,07
332283020	8595609110523	200	28/30x1,75	120x40x4	10	7,17
332283030	8595609110547	300	28/30x1,75	120x40x4	10	8,99
332283044	8595609110585	440	28/30x1,75	120x40x4	10	10,52
332283050	8595609110592	500	28/30x1,75	120x40x4	10	11,54
332384420	8595609110691	200	38/40x2	120x40x6	10	10,19
332384430	8595609110714	300	38/40x2	120x40x6	10	11,66
332384440	8595609110745	400	38/40x2	120x40x6	7	12,98
332384450	8595609110776	500	38/40x2	120x40x6	7	14,91



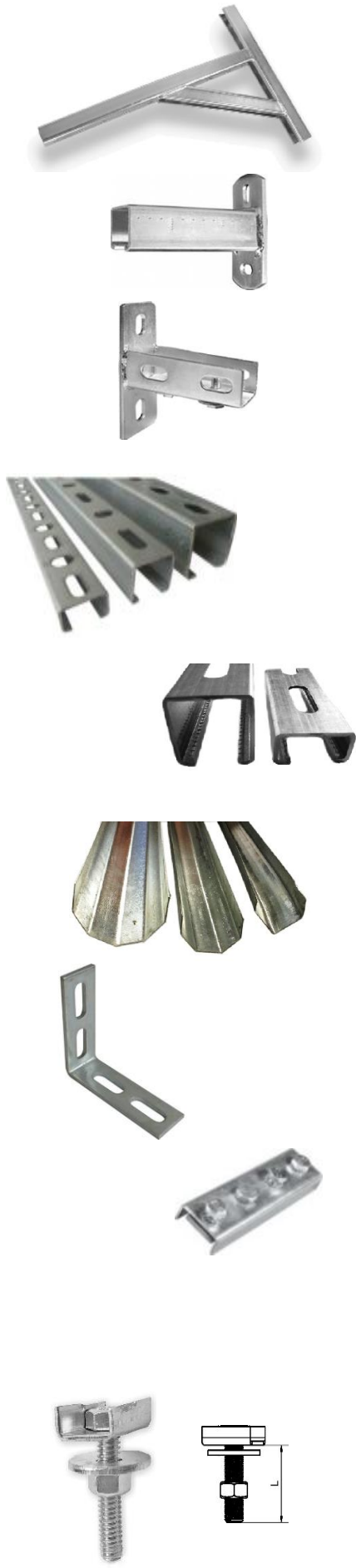

NOSILNA KONZOLA KLS

Koda	EAN	Dolžina (mm)	Dimenzije (mm)		Pakiranje (kos)	Cena
336020400	8595609112053	400	28/30	lahki	1	21,93
336020600	8595609112077	600	28/30	lahki	1	27,98
336030400	8595609112176	400	38/40	lahki	1	28,73
336030600	8595609112183	600	38/40	lahki	1	34,35

KRATKA STENSKA KONZOLA ST

Koda	EAN	Dolžina (mm)	Dimenzije (mm)	Za profil		Pakiranje (kos)	Cena
332841300	8595609111353	300	125x50x5	41/41	težki	1	13,79
332841500	8595609111414	500	125x50x5	41/41	težki	1	17,61

KRATKA STENSKA KONZOLA

Koda	EAN	Dimenzije (mm)	Za profil		Pakiranje (kos)	Cena
335000250	8595609111827	120x40x4	7/18, 28/30		50	7,29
335000255	8595609111858	145x60x6	38/40		20	15,99
335000257	8595609111872	145x60x6	38/40, 40/60, 41/62		20	20,63

NOSILNI PROFIL pocinkano jeklo

Koda	EAN	Dolžina (mm)	Dimenzije (mm)		Deb.(mm)	Pakiranje (kos)	Cena
331272000	8595609109299	2000	27/18	lahki	1,25	1	11,54
331273000	8595609109305	3000	27/18	lahki	1,25	1	17,35
331283020		2000	28/30	lahki	1,75	1	23,36
331283030	8595609109374	3000	28/30	lahki	2,00	1	33,65
331283040	8595609109381	6000	28/30	lahki	2,00	1	68,65
331276000	8595609109336	6000	27/18	lahki	2,00	1	33,81
331384020	8595609109879	2000	38/40	lahki	2,00	1	33,23
331384030	8595609109909	3000	38/40	lahki	2,00	1	49,58
331384063	8595609125282	6000	38/40	lahki	2,00	1	59,92

PODPORNI ŽLEB pocinkani

Koda	EAN	Širina x dolžina (mm)		Pakiranje (kos)	Cena
377200120	8595609113128	20 x 2000		10	4,13
377200125	8595609113135	25 x 2000		10	4,53
377200132	8595609113142	32 x 2000		10	5,63
377200140	8595609113159	40 x 2000		10	6,27
377200150	8595609113166	50 x 2000		10	7,56

MONTAŽNI KOTNIK

Koda	EAN	Tip	Dimenzije (mm)	Za profil		Pakiranje (kos)	Cena
337002745	8595609112282	27-45°	76 x 100 x 25 x 4	27/18 - 28/30	lahki	50	1,95
337002790	8595609112299	27-90°	87 x 81 x 25 x 4	27/18 - 28/30	lahki	50	1,95
337003890	8595609112312	38-90°	105 x 85 x 40 x 6	38/40, 4 luknje		20	5,61

H-SPOJKA ZA PROFIL

Koda	EAN		Za profil		Pakiranje (kos)	Cena
338000010	8595609112343	lahki	27/18 - 28/30		50	7,26
338000015	8595609112374	lahki	38/40		50	9,48

DRSNI NOSILEC

Koda	EAN	Navoj	Dolžina (mm)	Za profil		Pakiranje (kos)	Cena
331100830	8595609108780	M8	30	27/18 - 28/30		100	0,74
331100850	8595609108803	M8	50	27/18 - 28/30		100	0,76
331100880	8595609108827	M8	50	27/18 - 28/30		100	0,79
331100881	8595609108834	M8	80	27/18 - 28/30		100	1,19
331100898	8595609108841	M8	100	27/18 - 28/30		100	1,41
331101030	8595609108865	M10	30	38/40		100	1,56
331101051	8595609108896	M10	50	38/40		100	2,01
331101081	8595609108919	M10	80	38/40		100	1,81
331101101	8595609108933	M10	100	38/40		100	1,86
331101851	8595609109039	M8	50	38/40		100	1,98
331101882	8595609109053	M8	80	38/40		100	2,17

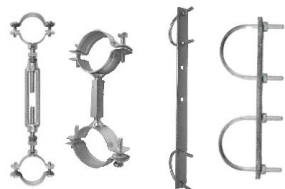

DRŽALO

Koda	EAN	Dolžina (mm)	Tip	Razpon (mm)	Pakiranje (kos)	Cena
350125054	8595609112497	5/4"	250 dolga	100	25	4,94
350324001	8595609112527	1"	100 dolga nastavljiva	200 - 240	25	11,27
350410054	8595609112558	5/4"	100 kratka	85 - 105	50	6,46



TRAPEZNI NOSILEC

Koda	EAN	Navoj	Tip	Dimenzije (mm)	Pakiranje (kos)	Cena
322030025	8595609107288	M8	z gumico	25 x 2	100	2,75
322010010	8595609107264	M10	z matico	25 x 2	100	1,62
322000008	8595609107233	M8	regulacijski	25 x 2	100	2,65
322040000	8595609107516	M8	tip ZV	67 x 30 x 2,5	500	2,06



ZIDNI NAVOJNI NOSILEC

Koda	EAN	Navoj	Dimenzije ploščice (mm)	Pakiranje (kos)	Cena
360710122	8595609112992	M10 x 120	40 x 40 x 2,5	50	1,57
360710123	8595609113005	M10 x 120	40 x 40 x 2,5	50	0,87



KOTNI NOSILEC

Koda	EAN	Odprtina (mm)	Višina (mm)	Za profil	Pakiranje (kos)	Cena
338002718	8595609112428	M6	85	27/18 - 28/30	25	5,95
338003840	8595609112435	M10	118	40/60 - 41/62	20	6,56



DRSNI SPOJNIK

Koda	EAN	Odprtina (mm)	Dimenzije (mm)	Za profil	Pakiranje (kos)	Cena
331527105	8595609110400	10,5	30 x 25 x 2,5	27/18 - 28/30	100	0,57
331500027	8595609110301	8,4	30 x 25 x 4	27/18 - 28/30	100	0,71
331500038	8595609110318	10,5	40 x 38 x 4	38/40	100	1,08



DRSNA MATICA

Koda	EAN	Navoj	Za profil	Pakiranje (kos)	Cena	
332902108	8595609138725	M8	M8 x 6	41/21 - 41/62	100	1,63



PODLOŽKA

Koda	EAN	Navoj	Pakiranje (kos)	Cena
331300308	8595609109497	M8 široka	100	0,11
331304008	8595609109534	M8	100	0,17
331304010	8595609109541	M10	100	0,18
331304012	8595609109558	M12	100	0,37



NAVOJNA PODLOŽKA za drsni nosilec (drsni spojnik)

Koda	EAN	Navoj	Za profil	Pakiranje (kos)	Cena
331227108	8595609109176	M8	27/18 - 28/30	100	0,34
331227110	8595609109190	M10	27/18 - 28/30	100	0,43
331228308	8595609109213	M8	38/40	100	0,74
331228310	8595609109220	M10	38/40	100	0,74

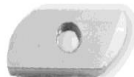

NAVOJNO OBEŠALO

Koda	EAN	Navoj	Odprtina (mm)	Pakiranje (kos)	Cena
321200008	8595609106854	M8	8,5	100	1,15
321200010	8595609106861	M10	10,5	100	1,38
321200012	8595609106878	M12	12,5	100	1,94



ZIDNI OJAČITVENI NOSILEC

Koda	EAN	Navoj	Dimenzije (mm)	Pakiranje (kos)	Cena	
321600854	8595609106885	M8	z matico	78 x 25 x 2,5	100	0,80
321600885	8595609106892	M8	z matico	120 x 40 x 4	50	3,15
321601054	8595609106908	M10	z matico	78 x 25 x 2,5	100	0,94
321601085	8595609106915	M10	z matico	120 x 40 x 4	50	2,97
321601087	8595609106922	M12	z matico	120 x 40 x 4	50	5,26





NOSILNA SPONA

Koda	EAN	Navoj	Za profil (mm)	Max.obt.(N)	Pakiranje (kos)	Cena
321700102	8595609107172	M8	0-18	1200	50	2,68
321700010	8595609107158	M10	0-20	2500	50	3,52
321700012	8595609107165	M12	0-20	3500	50	4,59



VERIGA

Koda	EAN	Naziv	Debelina (mm)	Nosilnost (kg)	Pakiranje (kos)	Cena
3R085A004	8595609118215	Veriga varjena pocinkan	4	125	30	6,13



VRV JEKLENA

Koda	EAN	Naziv	Debelina (mm)	Nosilnost (N)	Pakiranje (m)	Cena
3R2500004	8595609118789	Vrv jeklena	4	14900	100	2,33



SPONA ZA ŽIČNO VRV

Koda	EAN	Naziv	Pakiranje (kos)	Cena
3R2060002	8595609118567	Spona za žično vrv 4 - 5mm	50	0,58



PERFORIRAN TRAK V KOLUTU

Koda	EAN	Dimenzije (mm)	Pakiranje (kos)	Cena
321800017	8595609107219	17mm x 10m	10	10,22



NAVOJNA PALICA

Koda	EAN	Navoj	Dolžina (mm)	Pakiranje (kos)	Cena
322038121	8595609107318	M6	1000	100	1,64
322038223	8595609136912	M8	1000	50	1,55
322038224	8595609136929	M10	1000	25	3,33
322121000	8595609107561	M12	1000	20	5,53
322440803	8595609108261	M8	3000	25	5,40
322441003	8595609108278	M10	3000	25	9,12



HANGAR VIJAK (KOMBI - TORX)

Koda	EAN	Navoj	L (mm)	La / Lb (mm)	Pakiranje (kos)	Cena
321008060	8595609106625	M8 x 60 Torx	60	28/21	100	0,12
321008080	8595609106649	M8 x 80 Torx	80	37/30	100	0,16
321008100	8595609106656	M8 x 100 Torx	100	45/40	100	0,21
321008120	8595609106663	M8 x 120 Torx	120	47/50	100	0,26
321008140	8595609106670	M8 x 140 Torx	140	47/50	100	0,42
321008160	8595609106687	M8 x 160 Torx	160	47/50	100	0,34
321010080	8595609106717	M10 x 80 Torx	80	40/30	100	0,27
321010100	8595609106724	M10 x 100 Torx	100	57/30	100	0,33
321010120	8595609106731	M10 x 120 Torx	120	57/40	100	0,39
321010140	8595609106748	M10 x 140 Torx	140	57/40	50	0,48

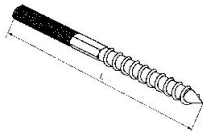

VIJAK Z METRIČNIM NAVOJEM

Koda	Navoj	Dolžina (mm)	Pakiranje (kos)	Cena	Koda	Navoj	Dolžina (mm)	Pakiranje (kos)	Cena
385606030	M6	30	100	0,10	385612030	M12	30	50	0,51
385608020	M8	20	100	0,17	385612050	M12	50	50	0,78
385608025	M8	25	100	0,20	385612080	M12	80	50	1,03
385608030	M8	30	100	0,22	385616055	M16	55	25	1,55
385608040	M8	40	100	0,24	385616060	M16	60	20	1,39
385608070	M8	70	100	0,35	385616065	M16	65	30	1,73
385608100	M8	100	100	0,62	385616070	M16	70	30	1,45
385610025	M10	25	100	0,36	385616080	M16	80	30	2,07
385610030	M10	30	100	0,44	385616090	M16	90	30	2,55
385610040	M10	40	100	0,45					



MATICA REDUCIRNA

Koda	EAN	Navoj	Dolžina (mm)	Pakiranje (kos)	Cena
325001012	8595609108681	M10/M12	21	10	2,35
325001208	8595609108698	M12/M8	23	10	2,69
325001210	8595609108704	M12/M10	23	10	2,75
325104812	8595609108742	M8/M12		10	2,20





MATICA

Koda	Navoj	Pakiranje (kos)	Cena	Koda	Navoj	Pakiranje (kos)	Cena
331400006	M6	100	0,04	331400012	M12	50	0,15
331400008	M8	100	0,05	331400016	M16	50	0,33
331400010	M10	100	0,10				



MATIČNA SPOJKA za ogrodni vijak

Koda	EAN	Navoj	Ključ	Dimenzije (mm)	Pakiranje (kos)	Cena
324081330	8595609108599	M8	13	30	100	0,32
324101320	8595609108605	M10	13	25	50	0,27
324101730	8595609108612	M10	17	30	50	0,51



TRIGLAV VLOŽEK

Koda	EAN	Navoj	Ø vrtanja (mm)	Gl.vrtanja (mm)	Pakiranje (kos)	Cena
380501007	8595609113401	M6	8	30	100	0,31
380501008	8595609121178	M8	10	30	100	0,29
380501009	8595609113418	M8	z robom	32	100	0,29
380501010	8595609126159	M10	12	42	100	0,41
380501012	8595609126166	M12	15	53	50	1,28



ZIDNI VLOŽEK ZA KNAUF

Koda	EAN	Dimenzije (mm)	Gl.vrtanja(mm)	Pakiranje (kos)	Cena
383010350	8595609114538	10 x 35	3,5 - 4 PVC	100	0,14
383010351	8595609114545	10 x 35	3,5 - 4 pocinkan	100	0,45



VIJAK STOJALNI, DIN 571

Koda	EAN	Dimenzije (mm)	Pakiranje (kos)	Cena
382180070	8595609114286	M8 x 70	100	0,27
382180120	8595609114316	M8 x 120	25	0,44



VIJAK SAMOREZNI

Koda	EAN	Dimenzije (mm)	Pakiranje (kos)	Cena
385601413	8595609115818	4,2 x 13	200	0,03
385601416	8595609115825	4,2 x 16	200	0,03
388542019	8595609116679	4,2 x 19 glava	200	0,04
385600519	8595609115689	4,8 x 19 glava	200	0,05



SPAX VIJAK

Koda	EAN	Dimenzije (mm)	Pakiranje (kos)	Cena
382140040	8595609114019	4 x 40	500	0,04
382140050	8595609126258	4 x 50	500	0,05
382150040	8595609114033	5 x 40	500	0,05
382150050	8595609114040	5 x 50	500	0,06
382150060	8595609114057	5 x 60	200	0,07
382150070	8595609114064	5 x 70	200	0,10
382160070	8595609114194	6 x 70	200	0,14



VIJAK ZA SIDRANJE V BETON

Koda	EAN	Navoj	Dolžina (mm)	Gl.vrtanja(mm)	Pakiranje (kos)	Cena
380700810	8595609113593	M8	75	60 8/10+23/76	50	0,99
380700830	8595609113609	M8	90	60 8/30+43/96	50	0,97
380701005	8595609113616	M10	70	50 10.05.1969	50	1,15
380701015	8595609113623	M10	90	70 10/15+23/89	50	1,46



MOLLY VIJAK s kovinskim vložkom za votle stene

Koda	EAN	Navoj	Dolžina (mm)	Pakiranje (kos)	Cena
380480613	8595609123653	M6	37	100	1,11
380480616	8595609123660	M6	50	100	1,12
380480624	8595609123677	M6	65	100	1,13
380480638	8595609123684	M6	80	100	1,19
380480816	8595609126128	M8	55	100	1,37
380480832	8595609126135	M8	65	100	1,54



ZAKLJUČNI ČEPI PVC za profile

Koda	EAN	Za profil	Pakirano (kos)	Cena
333002718	8595609111759	27/18	100	0,28
333002830	8595609111766	28/30	100	0,32
333004020	8595609110998	41/21	100	0,53



DRŽALA ZA BAKRENE CEVI PVC



Koda	EAN	Premer (mm)	Pakiranje (kos)	Cena
384004015	8595609115009	enojno 15	50	0,22
384004018	8595609115016	enojno 18	50	0,15
384004022	8595609115023	enojno 22	50	0,18
384004215	8595609115078	dvojno 2 x 15	50	0,48
384004218	8595609115092	dvojno 2 x 18	50	0,58
384004222	8595609115115	dvojno 2 x 22	50	0,60
384014015	8595609128405	enojno z zaporko 15	50	0,13
384014018	8595609128412	enojno z zaporko 18	50	0,15
384014022	8595609128429	enojno z zaporko 22	50	0,18
384004028	8595609115030	enojno z zaporko 28	50	0,36
384004035	8595609115054	enojno z zaporko 35	50	0,79
384024015	8595609128443	dvojno z zaporko 2 x 15	50	0,45
384024018	8595609128450	dvojno z zaporko 2 x 18	50	0,55
384024022	8595609128467	dvojno z zaporko 2 x 22	50	0,39
384024028	8595609128474	dvojno z zaporko 2 x 28	50	0,69

ROZETE PVC ENOJNE



Koda	Ø(mm)	Pakiranje (kos)	Cena	Koda	Ø(mm)	Pakiranje (kos)	Cena
384006012	D12 bela	50	0,46	384006215	D15 krom	50	1,42
384006015	D15 bela	50	0,43	384006218	D18 krom	50	1,42
384006018	D18 bela	50	0,28	384006222	D22 krom	50	1,38
384006022	D22 bela	50	0,42	384006228	D28 krom	50	1,29

OBJEMKA ZA FIKSIRANJE DOVODNIH CEVI



Koda	EAN	Dimenzije	Pakiranje (kos)	Cena
384182575	8595609115436	enojna N1 x 25 - 8/75	50	0,41
384183295	8595609115467	enojna N1 x 32 - 8/95	50	0,47
384283275	8595609115498	dvojna N2 x 32 - 8/75	50	0,50

SKOBE ZA TALNO OGREVANJE



Koda	EAN	Pakiranje (kos)	Cena/kos
390000305	8595609116747	tip C ročna	50 0,25
390000306	8595609116754	tip D pištolska	50 0,17

VEZICE bele



Koda	Dimenzije (mm)	Pakiranje (kos)	Cena	Koda	Dimenzije (mm)	Pakiranje (kos)	Cena
319625100	2,5 x 100	100	0,02	319635300	3,5 x 300	100	0,13
319625120	2,5 x 120	100	0,04	319635370	3,5 x 370	100	0,19
319625160	2,5 x 160	100	0,04	319648190	4,8 x 190	100	0,11
319625200	2,5 x 200	100	0,06	319648280	4,8 x 280	100	0,17
319635150	3,5 x 150	100	0,05	319648380	4,8 x 380	100	0,20
319635200	3,5 x 200	100	0,07	319648430	4,8 x 430	100	0,37
319635250	3,5 x 250	100	0,17				

HITROSUŠEČA MALTA V TUBI



Koda	EAN	Naziv	Pakiranje (kos)	Cena
381650300	8595609113869	Hitrosušeača malta tuba 280ml z nastavkom	1	37,21
381660000	8595609113906	Nastavek konica za tubo 280ml rezervni	1	1,90
381650304	8595609113883	Pištola za tubo 280ml	1	63,98

ZIDNI VLOŽEK ZA HITROSUŠEČO MALTO



Koda	EAN	Za vijak	Dolž.(mm)	Ø(mm)	Pakiranje (kos)	Cena
381611685	8595609113777	M8, M10, M12	85	16	4	1,34

REZALKA

Koda	EAN	Dimenzije (mm)	za rezanje	Pakiranje (kos)	Cena
394100122	8595609132693	125 x 1,0	TOP INOX jeklo / inox	1	4,85
394101228	8595609132716	230 x 1,9	TOP INOX jeklo / inox	1	12,52

*Po naročilu

IST CEV ALUMPLAST (v kolutu)

Koda	Dimenzije (mm)	Temp.(C°) / Tlak (bar)	V kolutu (m)	Cena / m
MULTIC.16-R200	16 x 2	20°C/25bar - 90°C/10bar	200	1,31
MULTIC.16-R450	16 x 2	20°C/25bar - 90°C/10bar	450	1,31
MULTIC.20-R50	20 x 2	20°C/25bar - 90°C/10bar	50	1,64
MULTIC.25-R50	25 x 2,5	* 20°C/25bar - 90°C/10bar	50	3,57
MULTIC.32-R50	32 x 3	20°C/25bar - 90°C/10bar	50	5,57



IST CEV PREDIZOLIRANA ALUMPLAST (v kolutu)

Koda	Dimenzije (mm)	Temp.(C°) / Tlak (bar)	Izolacija(mm)	V kolutu (m)	Cena / m
MC16AIS6-A	16 x 2	20°C/25bar - 90°C/10bar	6 - modra	50	1,89
MC20AIS6-A	20 x 2	20°C/25bar - 90°C/10bar	6 - modra	50	2,61
MC25AIS10-A	25 x 2,5	20°C/25bar - 90°C/10bar	10 - modra	25	4,68
MC32AIS-A	32 x 3	20°C/25bar - 90°C/10bar	10 - modra	25	7,99



IST CEV ALUMPLAST (palice)

Koda	Dimenzije (mm)	Temp.(C°) / Tlak (bar)	Palica (m)	Cena / m
MULTIC.16-B	16 x 2	20°C/25bar - 90°C/10bar	4	1,59
MULTIC.20-B	20 x 2	20°C/25bar - 90°C/10bar	4	2,46
MULTIC.25-B	25 x 2,5	20°C/25bar - 90°C/10bar	4	4,51
MULTIC.32-B	32 x 3	20°C/25bar - 90°C/10bar	4	7,39



ISTP BATERIJSKI PRIKLJUČEK notranji navoj

Koda	Dimenzije (mm)	Cena
CSH16X1/2	16 x 1/2"	6,14
CSH20X1/2	20 x 1/2"	7,03
CSH20X3/4	20 x 3/4"	8,86
CSH25X3/4	25 x 3/4"	9,38



ISTP KOLENO

Koda	Dimenzije (mm)	Cena
C16	16	3,90
C20	20	4,76
C25	25	7,79
C32	32	11,96

ISTP SPOJKA

Koda	Dimenzije (mm)	Cena
U16	16	2,99
U20	20	4,09
U25	25	6,30
U32	32	9,21



ISTP REDUCIRNA SPOJKA

Koda	Dimenzije (mm)	Cena
R20X16	20 x 16	3,90
R25X16	25 x 16	5,55
R25X20	25 x 20	5,67
R32X16	32 x 16	8,15
R32X20	32 x 20	8,17
R32X25	32 x 25	8,42



P. PRITRDILNA PLOŠČA M za baterijski priključek

Koda		Cena
1073	M1 dvojna	4,33
1075	M2 enojna	3,78
1076	M3 ravna	3,42



ISTP KOLENO zunanji navoj

Koda	Dimenzije (mm)	Cena
CM16X1/2	16 x 1/2"	4,61
CM16X3/4	16 x 3/4"	5,01
CM20X1/2	20 x 1/2"	5,36
CM20X3/4	20 x 3/4"	6,01
CM25X1/2	25 x 1/2"	6,98
CM25X3/4	25 x 3/4"	7,86
CM25X1	25 x 1"	10,02
CM32X1	32 x 1"	11,19



ISTP KOLENO notranji navoj

Koda	Dimenzije (mm)	Cena
CH16X1/2	16 x 1/2"	4,12
CH16X3/4	16 x 3/4"	5,43
CH20X1/2	20 x 1/2"	4,72
CH20X3/4	20 x 3/4"	5,98
CH25X1/2	25 x 1/2"	6,60
CH25X3/4	25 x 3/4"	7,40
CH25X1	25 x 1"	9,34
CH32X3/4	32 x 3/4"	8,86
CH32X1	32 x 1"	11,41



ISTP T-KOS

Koda	Dimenzije (mm)	Cena
T16	16	4,42
T20	20	6,33
T25	25	11,51
T32	32	16,07



ISTP T-KOS notranji navoj

Koda	Dimenzije (mm)	Cena
TH16X1/2	16 x 1/2" x 16	6,18
TH20X1/2	20 x 1/2" x 20	6,92
TH20X3/4	20 x 3/4" x 20	8,48
TH25X1/2	25 x 1/2" x 25	10,83
TH25X3/4	25 x 3/4" x 25	10,86
TH25X1	25 x 1" x 25	13,32
TH32X3/4	32 x 3/4" x 32	16,17
TH32X1	32 x 1" x 32	16,35



ISTP TT-KOS

Koda	Dimenzije (mm)	Cena
DC25202020	25x20x20x20	12,12
DC25201616	25x20x16x16	10,60
DC20201616	20x20x16x16	8,63
DC20202020	20x20x20x20	10,70
DC20162016	20x16x20x16	9,41



ISTP PREHODNI KOS PRESS na ZUNANJI NAVOJ

Koda	Dimenzije (mm)	Cena
EM16X3/8	16 x 3/8"	2,71
EM16X1/2	16 x 1/2"	2,87
EM16X3/4	16 x 3/4"	4,01
EM20X1/2	20 x 1/2"	3,28
EM20X3/4	20 x 3/4"	4,35
EM20X1	20 x 1"	5,66
EM25X1/2	25 x 1/2"	5,01
EM25X3/4	25 x 3/4"	5,53
EM25X1	25 x 1"	6,72
EM32X3/4	32 x 3/4"	6,66
EM32X1	32 x 1"	7,66
EM32X1-1/4	32 x 1 1/4"	10,18



ISTP PREHODNI KOS PRESS na NOTRANJI NAVOJ

Koda	Dimenzije (mm)	Cena
EH16X1/2	16 x 1/2"	3,39
EH16X3/4	16 x 3/4"	3,88
EH20X1/2	20 x 1/2"	3,55
EH20X3/4	20 x 3/4"	4,45
EH20X1	20 x 1"	6,18
EH25X1/2	25 x 1/2"	5,17
EH25X3/4	25 x 3/4"	5,37
EH25X1	25 x 1"	7,26
EH32X3/4	32 x 3/4"	6,21
EH32X1	32 x 1"	7,99



ISTP T-KOS reducirni

Koda	Dimenzije (mm)	Cena
TR20X16X20	20 x 16 x 20	6,47
TR20X16X16	20 x 16 x 16	6,44
TR16X20X16	16 x 20 x 16	6,47
TR16X25X16	16 x 25 x 16	6,95
TR20X20X16	20 x 20 x 16	6,47
TR25X20X25	25 x 20 x 25	11,33
TR25X20X20	25 x 20 x 20	9,88
TR20X25X20	20 x 25 x 20	9,94
TR25X25X20	25 x 25 x 20	10,26
TR25X16X25	25 x 16 x 25	10,13
TR25X20X16	25 x 20 x 16	9,39
TR25X16X20	25 x 16 x 20	9,58
TR25X32X25	25 x 32 x 25	15,68
TR25X16X16	25 x 16 x 16	7,61
TR32X25X32	32 x 25 x 32	15,62
TR32X25X25	32 x 25 x 25	15,13
TR32X20X32	32 x 20 x 32	15,25
TR32X25X20	32 x 25 x 20	15,07
TR32X16X32	32 x 16 x 32	15,68
TR32X32X25	32 x 32 x 25	15,98



ISTP PRIKLJUČEK ZA RADIATOR

Koda	Dimenzije (mm)	Cena
CR16X15	16 x 15	15,84



ISTP PREHODNI KOS Cu na Alu

Koda	Cev Cu na Alu	Cena
AD/C12-M16	12 na 16 x 2	1,84
AD/C15-M16	15 na 16 x 2	2,37
AD/C18-M16	18 na 16 x 2	2,62
AD/C15-M20	15 na 20 x 2	3,17
AD/C18-M20	18 na 20 x 2	3,57
AD/C22-M20	22 na 20 x 2	3,72
AD/C22-M25	22 na 25 x 2,5	4,72
AD/C28-M25	28 na 25 x 2,5	5,66
AD/C28-M32	28 na 32 x 3	6,27



ISTP PREHODNI KOS PRESS na HOLANDEC

Koda	Dimenzije (mm)	Cena
RM16X1/2	16 x 1/2"	3,39
RM16X3/4	16 x 3/4"	4,58
RM20X1/2	20 x 1/2"	3,80
RM20X3/4	20 x 3/4"	5,20
RM20X1	20 x 1"	7,44
RM25X1/2	25 x 1/2"	7,68
RM25X3/4	25 x 3/4"	8,38
RM25X1	25 x 1"	11,75
RM32X1	32 x 1"	13,14





ISTP ČEP PRESS		
Koda	Dimenzije (mm)	Cena
TAP-P16	16 x 2	2,29



ISTP INOX SPOJKA		
Koda	Dimenzije (mm)	Cena
CI16	16	0,74
CI20	20	0,77
CI25	25	1,16
CI32	32	1,38



ISTP ČEP VIJAČNI		
Koda	Dimenzije (mm)	Cena
TAP16R	16	3,57



ISTP EUROKONUS		
Koda	Dimenzije (mm)	Cena
EURMC16X3/4	16 x 3/4"	4,66
EURMC20X3/4	20 x 3/4"	5,29



ISTP PODOMETNI KROGELNI VENTIL		
Koda	Dimenzije (mm)	Cena
VAL16	16 x 2	15,49
VAL20	20 x 2	18,79
VAL25	25 x 2	21,01
VAL32	32 x 2	23,92



ISTP KALIBRATOR		
Koda	Dimenzije (mm)	Cena
A161820	16-18-20	20,00
A202532	20-25-32	21,43



ISTP KROGELNI VENTIL		
Koda	Dimenzije (mm)	Cena
VAL-LIN16	16 x 2	11,09
VAL-LIN20	20 x 2	11,93
VAL-LIN25	25 x 2	18,40
VAL-LIN32	32 x 3	22,05



ISTP VZMET NOTRANJA		
Koda	Dimenzije (mm)	Cena
MUELLE1216	16	8,72
MUELLE1620	20	9,43
MUELLE2025	25	10,43
MUELLE2632	32	15,92



ISTP KAPA VENTILA Z ROZETO		
Koda	Dimenzije (mm)	Cena
MO	16	6,01



ISTP VZMET ZUNANJA		
Koda	Dimenzije (mm)	Cena
MUELL-EX16	16	12,22
MUELL-EX20	20	14,62
MUELL-EX25	25	16,36
MUELL-EX32	32	20,93



ISTP PVC OBROČEK		
Koda	Dimenzije (mm)	Cena
JE16	16	0,50
JE20	20	0,54
JE25	25	0,56
JE32	32	0,61



ISTP GUMI TESNILO		
Koda	Dimenzije (mm)	Cena
JG16	16	0,57
JG20	20	0,57
JG25	25	0,65
JG32	32	0,65



ISTP KLEŠČE za alumplast		
Koda	Dimenzije (mm)	Cena
TIJ 16-32	16-32	21,35



ISTP LUBRIFIKATOR		
Koda		Cena
L-400	za vlaženje spojev	24,29

ISTV BATERIJSKI PRIKLJUČEK



Koda	Dimenzije (mm)	Cena
CSHCO1612	16 x 1/2"	6,71
CSHCO2012	20 x 1/2"	8,91

ISTV SPOJKA



Koda	Dimenzije (mm)	Cena
UCO16	16	5,67
UCO20	20	9,33
UCO25	25	16,35
UCO32	32	19,95

ISTV KOLENO



Koda	Dimenzije (mm)	Cena
CCO16	16	6,22
CCO20	20	9,58
CCO25	25	14,52
CCO32	32	23,77

ISTV PREHODNI KOS notranji navoj



Koda	Dimenzije (mm)	Cena
EHCO1612	16 x 1/2"	3,88
EHCO1634	16 x 3/4"	5,19
EHCO2012	20 x 1/2"	6,04
EHCO2034	20 x 3/4"	6,16
EHCO2534	25 x 3/4"	11,04
EHCO251	25 x 1"	12,81
EHCO3234	32 x 3/4"	12,64
EHCO321	32 x 1"	13,62

ISTV T-KOS reducirni



Koda	Dimenzije (mm)	Cena
TRCO162016	16 x 20 x 16	11,59
TRCO201620	20 x 16 x 20	12,57
TRCO202016	20 x 20 x 16	12,57
TRCO251625	25 x 16 x 25	19,89
TRCO252020	25 x 20 x 20	20,50
TRCO252025	25 x 20 x 25	21,72
TRCO321632	32 x 16 x 32	24,25
TRCO322032	32 x 20 x 32	23,67
TRCO322532	32 x 25 x 32	26,77

ISTV T-KOS notranji navoj



Koda	Dimenzije (mm)	Cena
THCO1612	16 x 1/2"	8,30
THCO2012	20 x 1/2"	11,59
THCO2034	20 x 3/4"	14,40
THCO2534	25 x 3/4"	20,13
THCO321	32 x 1"	25,80

ISTV PODOMETNI KROGELNI VENTIL



Koda	Dimenzije (mm)	Cena
VALCO16	16	22,45
VALCO20	20	26,17
VALCO25	25	28,65
VALCO32	32	36,05

ISTV KAPA VENTILA Z ROZETO



Koda	Dimenzije (mm)	Cena
MO	16	6,01

ISTV REDUCIRKA



Koda	Dimenzije (mm)	Cena
RCO2016	20-16	7,69
RCO2520	25-20	11,96
RCO3225	32-25	17,26

ISTV KOLENO zunanji navoj



Koda	Dimenzije (mm)	Cena
CMCO1612	16 x 1/2"	5,12
CMCO2012	20 x 1/2"	6,71
CMCO2534	25 x 3/4"	11,96

ISTV KOLENO notranji navoj



Koda	Dimenzije (mm)	Cena
CHCO1612	16 x 1/2"	5,06
CHCO1634	16 x 3/4"	6,22
CHCO2012	20 x 1/2"	6,95
CHCO2034	20 x 3/4"	8,05
CHCO2534	25 x 3/4"	11,83
CHCO251	25 x 1"	12,81
CHCO321	32 x 1"	15,01

ISTV PREHODNI KOS zunanji navoj



Koda	Dimenzije (mm)	Cena
EMCO1612	16 x 1/2"	3,84
EMCO1634	16 x 3/4"	4,72
EMCO2012	20 x 1/2"	5,80
EMCO2034	20 x 3/4"	5,73
EMCO2534	25 x 3/4"	9,27
EMCO251	25 x 1"	9,64
EMCO3234	32 x 3/4"	12,74
EMCO321	32 x 1"	14,87

ISTV PREHODNI KOS Cu na Alu



Koda	Dimenzije (mm)	Cena
AD/C12-M16	12 na 16 x 2	1,84
AD/C15-M16	15 na 16 x 2	2,37
AD/C18-M16	18 na 16 x 2	2,62
AD/C15-M20	15 na 20 x 2	3,17
AD/C18-M20	18 na 20 x 2	3,57
AD/C22-M20	22 na 20 x 2	3,72
AD/C22-M25	22 na 25 x 2,5	4,72
AD/C28-M25	28 na 25 x 2,5	5,66
AD/C28-M32	28 na 32 x 3	6,27

ISTV T-KOS



Koda	Dimenzije (mm)	Cena
TCO16	16	8,85
TCO20	20	13,91
TCO25	25	23,79
TCO32	32	27,16

ISTV KROGELNI VENTIL



Koda	Dimenzije (mm)	Cena
VAL-LINCO16	16	18,54
VAL-LINCO20	20	22,94
VAL-LINCO25	25	32,21
VAL-LINCO32	32	32,23

ISTV ČEP VIJAČNI



Koda	Dimenzije (mm)	Cena
TAP16-R	16	3,57

ALKATEN CEV PN16



Koda	Naziv	DN	PN	m/pak	Cena/m
2619	Alkaten cev	20	16 bar	200	0,67
2620	Alkaten cev	25	16 bar	200	0,95
2621	Alkaten cev	32	16 bar	200	1,51
2622	Alkaten cev	40	16 bar	200	2,34
2623	Alkaten cev	50	16 bar	200	3,65
2624	Alkaten cev	63	16 bar	200	5,77
2625	Alkaten cev	75	16 bar	100	8,08
2626	Alkaten cev	90	16 bar	100	11,66
2627	Alkaten cev	110	16 bar	100	17,39

ALKATEN SPOJKA ENOJNA zunanji navoj



Koda	DN	Cena
3121	20-1/2"	1,59
3122	20-3/4"	1,66
3123	25-1/2"	1,73
3124	25-3/4"	1,78
3125	25-1"	1,85
3126	32-1/2"	2,03
3127	32-3/4"	2,05
3128	32-1"	2,10
3129	32-5/4"	2,17
3130	40-1"	2,81
3131	40-5/4"	2,88
3132	40-6/4"	2,98
31323V	50-5/4"	7,61
3133	50-6/4"	7,71
3197	50-2"	7,78
31972	63-6/4"	9,20
3134	63-2"	9,27
31342	75-2"	14,52
31343	75-2½"	14,62
31344	75-3"	8,93
31345	90-2"	16,88
31346	90-2½"	30,72
31347	90-3"	34,53
31961	110-2"	30,91
31962	110-3"	63,03
31963	110-4"	31,11

ALKATEN SPOJKA DVOJNA



Koda	DN	Cena
3100	20-20	2,61
3101	25-25	3,15
3102	32-32	3,95
3103	40-40	6,32
3104	50-50	9,88
3105	63-63	12,64
3216	75-75	26,84
32161	90-90	51,34
32162	110-110	94,75

ALKATEN SPOJKA REDUCIRNA



Koda	DN	Cena
3106	25-20	2,76
3107	32-20	4,05
3108V	32-25	4,15
3109	40-25	4,39
3110	40-32	4,54
3111	50-32	15,20
3112	50-40	15,40
3113	63-40	16,59
3114	63-50	16,59
31141	75-50	19,37
3209	90-63	47,78
32091	90-75	42,99
32092	110-90	100,67

ALKATEN ČEP



Koda	DN	Cena
3172	20	1,98
3173	25	2,37
3174	32	2,76
3175	40	4,34
3176	50	6,71
3177	63	9,08
31771	75	18,96
31772	90	37,50
31773	110	72,57

ALKATEN T- KOS



Koda	DN	Cena
3135	20-20-20	2,76
3136V	25-25-25	3,37
3137V	32-32-32	7,30
3138	40-40-40	7,91
3139	50-50-50	11,05
3140	63-63-63	20,91
31401	75-75-75	33,16
31402	90-90-90	86,86
31403	110-110-110	134,25

ALKATEN T- KOS notranji navoj



Koda	DN	Cena
3162V	20-1/2"-20	2,85
3163	25-1/2"-25	3,25
3164	25-3/4"-25	3,27
3203V	32-1/2"-32	3,22
3204V	32-3/4"-32	3,25
3165	32-1"-32	5,29
3166	40-1"-40	6,08
3167	40-5/4"-40	6,08
3168	50-5/4"-50	13,03
3169	50-6/4"-50	13,03
3170	63-6/4"-63	23,69
3171	63-2"-63	23,69
31712	75-2½"-75	34,84

ALKATEN T- KOS REDUCIRNI



Koda	DN	Cena
3141	25-20-25	5,12
3142	32-20-32	6,32
3143	32-25-32	6,32
3144	40-25-40	7,91
3145	40-32-40	7,93
3146	50-32-50	15,40
3147	50-40-50	15,40
3148	63-25-63	22,47
3149	63-32-63	22,50
3150	63-40-63	15,76
3151	63-50-63	23,69
31511	75-63-75	31,35
31513	90-75-90	75,76
31514	110-90-110	134,25

ALKATEN T- KOS zunanji navoj



Koda	DN	Cena
3152V	20-1/2"-20	2,85
3153	25-1/2"-25	3,25
3154	25-3/4"-25	3,25
3201	32-1/2"-32	3,42
3202V	32-3/4"-32	4,15
3155	32-1"-32	5,29
3156	40-1"-40	6,08
3157	40-5/4"-40	6,08
3158	50-5/4"-50	13,79
3159	50-6/4"-50	13,03
3160	63-6/4"-63	15,79
3161	63-2"-63	15,79
31612	90-3"-90	77,45

ALKATEN KOLENO ENOJNO notranji navoj



Koda	DN	Cena
3191V	20-1/2"	1,98
3192	25-3/4"	2,85
3193	32-1"	3,25
3194V	40-5/4"	4,15
3205V	50-6/4"	7,91
3195	63-2"	9,47

ALKATEN KOLENO ENOJNO zunanji navoj



Koda	DN	Cena
3179V	20-1/2"	1,98
3180	20-3/4"	2,03
3181	25-1/2"	2,05
3182	25-3/4"	2,37
3183	32-1/2"	2,71
3184	32-3/4"	2,71
3185	32-1"	2,76
3186	40-1"	4,10
3187	40-5/4"	4,15
3188	40-6/4"	4,17
3189	50-5/4"	7,86
3206	50-6/4"	7,91
3207	50-2"	7,93
3208	63-6/4"	9,47
3190	63-2"	9,47
31904	90-3"	33,57

ALKATEN KOLENO DVOJNO



Koda	DN	Cena
3115	20-20	2,61
3116	25-25	3,15
3117	32-32	3,66
3118	40-40	5,34
3119	50-50	9,08
3120	63-63	13,83
31201	75-75	24,08
31102	90-90	67,12
31103	110-110	90,82

PP-R FIBERGLASS CEV (PN20) za vodovod-ogrevanje-komprimiran zrak



Koda	DN	Temperatura (C°)		Enota	Cena
2813	20	zelena	90	m	2,33
2814	25	zelena	90	m	3,69
2815	32	zelena	90	m	6,28
2816	40	zelena	90	m	9,31
2817	50	zelena	90	m	14,73
2818	63	zelena	90	m	23,28

PP-R PRITRDILNO KOLENO notranji navoj

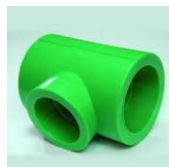

Koda	DN	Cena
2863	20-1/2"	3,965
2864	25-3/4"	5,047
2917	20-3/4"	7,330

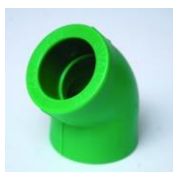
PP-R T-KOS

Koda	DN	Cena
2831	20	0,476
2832	25	0,773
2833	32	1,932
2834	40	3,865
2835	50	5,946
2836	63	11,416

PP-R KOLENO 45°

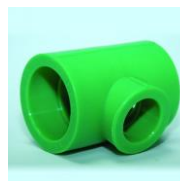
Koda	DN	Cena
2819	20-45	0,386
2820	25-45	0,476
2821	32-45	1,219
2822	40-45	2,646
2823	50-45	3,835
2824	63-45	8,423

PP-R T-KOS reducirni

Koda	DN	Cena
2918	25-20-25	1,159
2919	32-20-32	1,932
2920	32-25-32	1,932
2933	40-25-40	5,241
2906	40-32-40	4,758
2907	50-32-50	8,654
2908	50-40-50	9,249
2912V	63-25-63	6,958
2909	63-40-63	13,804
2911	63-50-63	14,402

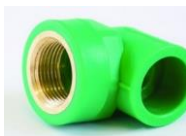
PP-R PREHODNO KOLENO notranji navoj

Koda	DN	Cena
2880	20-1/2"	3,965
2881	25-3/4"	5,377
2915	32-1"	11,235

PP-R T-KOS notranji navoj

Koda	DN	Cena
2857	20 -1/2"-20	4,626
2858	25-3/4"-25	5,678
2859	32-1"-32	11,025

PP-R KOLENO M/Ž



Koda	DN	Cena
2952	20	0,850

PP-R PRITRDILNO KOLENO zunanji navoj

Koda	DN	Cena
2865	20-1/2"	5,077
2866	25-3/4"	7,180
2912	20-3/4"	7,330

PP-R T-KOS zunanji navoj

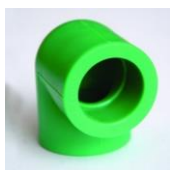
Koda	DN	Cena
2860	20 -1/2"-20	5,347
2861	25-3/4"-25	7,811
2862	32-1"-32	17,093

PP-R KOLENO 90°

Koda	DN	Cena
2825	20-90	0,386
2826	25-90	0,535
2827	32-90	1,605
2828	40-90	3,300
2829	50-90	4,846
2830	63-90	8,413

PP-R T-PREHODNI KOS



Koda	DN	Cena
2873	20	4,626
2874	25	5,678
2875	32	11,025

PP-R PREHODNO KOLENO zunanji navoj

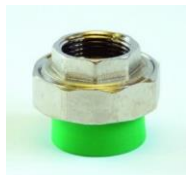

Koda	DN	Cena
2882	20-1/2"	5,137
2883	25-3/4"	7,060
2916V	32-1"	15,922

PP-R T-KOS Z IZPUSTOM

Koda	DN	Cena
2930	20	7,210
2931	25	8,178

PP-R HOLANDEC notranji navoj

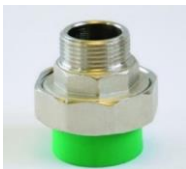
Koda	DN	Cena
2901	20-1/2"	8,291
2900	25-3/4"	12,287
2902	32-1"	14,220

PP-R HOLANDEC zunanji navoj

Koda	DN	Cena
2903	20-1/2"	6,489
2904	25-3/4"	9,523
2905	32-1"	15,955

PP-R PREHODNI KOS notranji navoj

Koda	DN	Cena
2867	20-1/2"	4,206
2868	25-3/4"	4,777
2869	32-1"	9,373
2924	40-5/4"	34,668
2925	50-6/4"	57,139
2926	63-2"	65,460

PP-R PREHODNI KOS zunanji navoj

Koda	DN	Cena
2870	20-1/2"	4,626
2871	25-3/4"	8,321
2872	32-1"	14,900
2927	40-5/4"	51,521
2928	50-6/4"	64,378
2929	63-2"	76,876

PP-R VENTIL PODOMETNI zaporni

Koda	DN	Cena
2921	20	11,716
2922	25	14,390
2879	32	30,563

PP-R VENTIL PODOMETNI s kapo

Koda	DN	Cena
2877	20	11,891
2878	25	15,264

PP-R REDUCIRKA

Koda	DN	Cena
2843	25-20	0,327
2844	32-20	0,476
2845	32-25	0,476
2846	40-20	1,219
2847V	40-25	1,219
2848	40-32	1,219
2849	50-20	1,992
2850	50-25	1,992
2851	50-32	1,992
2852	50-40	1,843
2853	63-25	4,073
2854	63-32	4,073
2855	63-40	4,073
2856	63-50	4,106

PP-R SPOJKA

Koda	DN	Cena
2837	20	0,327
2838	25	0,386
2839	32	1,011
2840	40	1,932
2841	50	2,943
2842	63	5,856

PP-R IZOGIBNI LOK ekstrudirani

Koda	DN	Cena
2895	20	2,213
2894	25	3,468

PP-R IZOGIBNI LOK brizgani

Koda	DN	Cena
2892	20	1,784
2893	25	1,932

PP-R ZAKLJUČNI ČEP

Koda	DN	Cena
2884	20	0,297
2885	25	0,386
2886	32	0,713
2887	40	1,605
2888	50	2,408
2889	63	4,013

PVC ČEP modri/rdeči

Koda	DN		Cena
2913V	1/2"	rdeči	1,043
2686	1/2"	modri	0,759
2914V	3/4"	rdeči	1,565
2685	3/4"	modri	1,161

TROJNI HIŠNI FILTER EKO-TRIPLEX-MAGO-EKO-FOS, R^{3/4}"



Koda		Cena
83409	R 3/4"	229,36
Max. obratovalni tlak 7bar. Max. temperatura vode 30°C. Višina 310mm.		
82822	Mehanski vl.z mrežico	
88879	Kombinirani vl.s kristali	
82624	Vložek aktivno oglje	

TROJNI HIŠNI FILTER EKO-TRIS R^{3/4}"



Koda		Cena
86660	EKO TRIS 3/4"	169,58
Max. obratovalni tlak 7bar. Max. temperatura vode 30°C. Višina 310mm.		
80415	Mehanski filt.vložek	
88879	Kombinirani vl.pleteni	
82624	Vložek aktivno oglje	

DVOJNI HIŠNI FILTER ZA VODO EKO-DUPLEX R^{3/4}"



Koda		Cena
82549	R 3/4"	152,13
Max. obratovalni tlak 7bar. Max. temperatura vode 30°C. Višina 310mm.		
80415	Vložek mehanski z mrežico	
82617	Vložek mehanski z inox mrežico	

DVOJNI HIŠNI FILTER ZA DEŽEVNICO EKO-TWIN 3/4"



Koda		Cena
87797	R 3/4"	78,32
Max. obratovalni tlak 7bar. Max. temperatura vode 30°C. Višina 310mm.		
80514	Mehanski vl. polypropylen	
80903	Vložek aktivno oglje	

TROSMERNI MEHČALEC VODE EKOM^{1/2}"



Koda		Cena
89197	R ^{1/2} "	31,60
Max. obratovalni tlak 7bar. Max. temperatura vode 30°C. Višina 310mm.		
Mehčalec za pitno vodo s kristali polyphosphat		

TROJNI HIŠNI FILTER ZA DEŽEVNICO EKO-TRIPLE 3/4"



Koda		Cena
88671	EKO TRIPLE 3/4"	114,68
Max. obratovalni tlak 7bar. Max. temperatura vode 30°C. Višina 310mm.		
80415	Mehanski filt.vložek z mrežico	
80514	Mehanski vl.polypropylen	
80903	Vložek aktivno oglje	

FILTRI ZA TOPLLOTNE ČRPALKE



Koda		Cena
85267	19,05 mm (R 3/4) višina 10"	66,38
85274	25,4 mm (R 1) višina 10"	69,24
85281	31,75 mm (R 5/4) višina 10"	78,35
82426	Mehanski filt. vložek z mrežico	
85243	Mehanski filt. vložek z mrežico	

SAMOČISTILNI MEHANSKI FILTER ZA VODO R^{3/4}"



Koda		Cena
82129	R 3/4" (malo ohišje)	81,74
Max. obratovalni tlak 7bar. Max. temperatura vode 30°C. Višina 310mm.		
82822	Mehanski filtrni vložek za samočistilni filter za vodo z mrežico, 60mcr, višina 10"	

MAGO-EKO-FOS kombinirani mehanski filter 3/4"



Koda		Cena
88923	R 3/4" 10"	169,58
Max. obratovalni tlak 7bar. Max. temperatura vode 30°C. Višina 310mm.		
Z magnetnim nevtralizatorjem vodnega kamna		
89395	Deljeni mehanski vložek z mrežico	

MEHČALEC ZA PRALNI STROJ 3/4"



Koda		Cena
80095	R ^{3/4} " DOSAL	15,40

Mehčalec za pitno vodo s kristali polyphosphat. Vgradimo ga neposredno pred uporabniki vode kot so: pralni stroj, pomivalni stroj, likalnik. Menjava na 6 - 12 mesecev.

ELEKTRIČNI MEHČALEC VODNEGA KAMNA AQUA 2000



Montaža na dovodne bakrene, pocinkane, inox in alkatene vodovodne cevi, pretok 50l/min, frekvenca pulznega delovanja med 7 in 14kHz, zanemarljiva poraba el.energije

Koda	Naziv	Cena
2000-B	Električni mehčalec vodnega kamna Aqua 2000	237,90

VLOŽKI ZA FILTRE



Koda	Naziv	Cena
82822	Mehanski filterni vložek za samočistilni filter za vodo z mrežico, višina 9¾" (60 µm)	17,81
88879	Kombinirani vložek filtra pleteni s s kristali, višina 10" (25µm)	18,06
82839	Ekstrudirani mehanski vložek EPP polypropilen višina 128mm, (5µm)	7,23
80903	Vložek filtra aktivno oglje (carbon block) - sintrano, višina 9¾" (10µm)	16,84
82624	Vložek filtra aktivno oglje (carbon block) - sintrano, višina 9¾" (5µm)	17,81
80415	Vložek filtra mehanski z mrežico, višina 9¾" (50µm)	11,98
80514	Vložek filtra polypropylen za ohišje R¾" in R1", višina 10" mehanski, pleteni	4,82
80415	Vložek filtra mehanski s polyester mrežico, višina 10"SX (50µm)	11,98
80330	Vložek filtra za mehčanje vode s polnilom polyphosphat, višina 9¾"	20,11
82143	Vložek filtra mehanski, višina 9¾" (5µm)	8,14
82280	Vložek filtra aktivno oglje, višina 128mm, (5µm)	21,90
80552	Vložek filtra aktivno oglje, višina 248mm, (0,3µm)	39,04
80101	Dozirno sredstvo za mehčanje vode -polyphosphat (pakirano 0,5kg)	8,42
85885	Tesnilo filtra 1/2"	1,89
89944	Tesnilo filtra 3/4"	1,89

KANALIZACIJSKA CEV HTEM PRO - 1 grlo

Koda	EAN	Naziv	Cena
C032PRO0150	3831020520721	CEV HTEM PRO 32/150	1,002
C032PRO0250	3831020520738	CEV HTEM PRO 32/250	1,549
C032PRO0500	3831020520745	CEV HTEM PRO 32/500	2,520
C032PRO1000	3831020532410	CEV HTEM PRO 32/1000	4,151
C032PRO1500	3831020520752	CEV HTEM PRO 32/1500	5,979
C032PRO2000	3831020520769	CEV HTEM PRO 32/2000	7,738
C032PRO3000	3831020520776	CEV HTEM PRO 32/3000	10,033
C040PRO0150	3831020520851	CEV HTEM PRO 40/150	1,455
C040PRO0250	3831020520868	CEV HTEM PRO 40/250	1,496
C040PRO0500	3831020520875	CEV HTEM PRO 40/500	2,308
C040PRO1000	3831020532380	CEV HTEM PRO 40/1000	4,136
C040PRO1500	3831020520882	CEV HTEM PRO 40/1500	5,863
C040PRO2000	3831020520899	CEV HTEM PRO 40/2000	7,302
C040PRO3000	3831020520905	CEV HTEM PRO 40/3000	10,451
C050PRO0150	3831020520585	CEV HTEM PRO 50/150	1,455
C050PRO0250	3831020520592	CEV HTEM PRO 50/250	2,036
C050PRO0500	3831020520608	CEV HTEM PRO 50/500	3,021
C050PRO1000	3831020532427	CEV HTEM PRO 50/1000	4,961
C050PRO1500	3831020520615	CEV HTEM PRO 50/1500	7,109
C050PRO2000	3831020520622	CEV HTEM PRO 50/2000	9,014
C050PRO3000	3831020520639	CEV HTEM PRO 50/3000	13,182
C075PRO0150	3831020520998	CEV HTEM PRO 75/150	2,196
C075PRO0250	3831020521001	CEV HTEM PRO 75/250	3,262
C075PRO0500	3831020521018	CEV HTEM PRO 75/500	4,490
C075PRO1000	3831020532434	CEV HTEM PRO 75/1000	7,170
C075PRO1500	3831020521025	CEV HTEM PRO 75/1500	11,390
C075PRO2000	3831020521032	CEV HTEM PRO 75/2000	12,454
C075PRO3000	3831020521049	CEV HTEM PRO 75/3000	19,789
C090PRO0150	3831020521131	CEV HTEM PRO 90/150	3,827
C090PRO0250	3831020521148	CEV HTEM PRO 90/250	4,669
C090PRO0500	3831020521155	CEV HTEM PRO 90/500	7,109
C090PRO1000	3831020532397	CEV HTEM PRO 90/1000	10,935
C090PRO1500	3831020521162	CEV HTEM PRO 90/1500	16,493
C090PRO2000	3831020521179	CEV HTEM PRO 90/2000	19,451
C090PRO3000	3831020521186	CEV HTEM PRO 90/3000	26,188
C110PRO0150	3831020532502	CEV HTEM PRO 110/150	3,827
C110PRO0250	3831020532465	CEV HTEM PRO 110/250	5,153
C110PRO0500	3831020532519	CEV HTEM PRO 110/500	7,820
C110PRO1000	3831020532441	CEV HTEM PRO 110/1000	11,985
C110PRO1500	3831020532472	CEV HTEM PRO 110/1500	18,157
C110PRO2000	3831020532403	CEV HTEM PRO 110/2000	21,420
C110PRO3000	3831020532557	CEV HTEM PRO 110/3000	32,729
C125PRO0150	3831020532076	CEV HTEM PRO 125/150	7,788
C125PRO0250	3831020532038	CEV HTEM PRO 125/250	8,271
C125PRO0500	3831020532113	CEV HTEM PRO 125/500	11,663
C125PRO1000	3831020532120	CEV HTEM PRO 125/1000	18,188
C125PRO1500	3831020532137	CEV HTEM PRO 125/1500	23,939
C125PRO2000	3831020532090	CEV HTEM PRO 125/2000	29,336
C125PRO3000	3831020532144	CEV HTEM PRO 125/3000	46,103
C160PRO0150	3831020532175	CEV HTEM PRO 160/150	10,451
C160PRO0250	3831020532274	CEV HTEM PRO 160/250	14,409
C160PRO0500	3831020532281	CEV HTEM PRO 160/500	19,078
C160PRO1000	3831020532298	CEV HTEM PRO 160/1000	29,952
C160PRO1500	3831020532243	CEV HTEM PRO 160/1500	43,310
C160PRO2000	3831020532304	CEV HTEM PRO 160/2000	50,046
C160PRO3000	3831020532250	CEV HTEM PRO 160/3000	73,468





KOLENO HTB

Koda	EAN	Naziv	Cena
K032000015ARGO	3831020500341	KOLENO HTB 32/15°	1,000
K032000030ARGO	3831020500358	KOLENO HTB 32/30°	1,000
K032000045	3831020500716	KOLENO HTB 32/45°	1,000
K032000067	3831020500365	KOLENO HTB 32/67°	1,000
K032000087	3831020500723	KOLENO HTB 32/87°	1,000
K040000015	3831020500761	KOLENO HTB 40/15°	1,000
K040000030	3831020500778	KOLENO HTB 40/30°	1,000
K040000045	3831020500785	KOLENO HTB 40/45°	1,000
K040000067	3831020500792	KOLENO HTB 40/67°	1,000
K040000087	3831020500808	KOLENO HTB 40/87°	1,000
K050000015	3831020500815	KOLENO HTB 50/15°	1,169
K050000030	3831020500822	KOLENO HTB 50/30°	1,169
K050000045	3831020500839	KOLENO HTB 50/45°	1,169
K050000067	3831020500846	KOLENO HTB 50/67°	1,169
K050000087	3831020500853	KOLENO HTB 50/87°	1,169
K075000015	3831020500372	KOLENO HTB 75/15°	3,159
K075000030	3831020500389	KOLENO HTB 75/30°	3,159
K075000045	3831020500860	KOLENO HTB 75/45°	2,281
K075000067	3831020500396	KOLENO HTB 75/67°	3,159
K075000087	3831020500877	KOLENO HTB 75/87°	2,281
K090000015	3831020526068	KOLENO HTB 90/15°	4,996
K090000030	3831020526075	KOLENO HTB 90/30°	4,996
K090000045	3831020526082	KOLENO HTB 90/45°	4,996
K090000067	3831020526099	KOLENO HTB 90/67°	4,996
K090000087	3831020526105	KOLENO HTB 90/87°	4,996
K110000015	3831020500914	KOLENO HTB 110/15°	3,865
K110000030	3831020500921	KOLENO HTB 110/30°	3,865
K110000045	3831020500938	KOLENO HTB 110/45°	3,865
K110000067	3831020500945	KOLENO HTB 110/67°	3,865
K110000087	3831020500952	KOLENO HTB 110/87°	3,865
K125000015	3831020500983	KOLENO HTB 125/15°	15,037
K125000030	3831020500990	KOLENO HTB 125/30°	15,037
K125000045	3831020500969	KOLENO HTB 125/45°	7,183
K125000067	3831020501058	KOLENO HTB 125/67°	16,301
K125000087	3831020500976	KOLENO HTB 125/87°	7,183
K160000015	3831020501034	KOLENO HTB 160/15°	22,088
K160000030	3831020501041	KOLENO HTB 160/30°	22,088
K160000045	3831020501010	KOLENO HTB 160/45°	11,540
K160000087	3831020501027	KOLENO HTB 160/87°	11,540

WC KOLENA

Koda	EAN	Naziv	Cena
W110000090SID	3831020527201	WC KOLENO110/90 ODCEP 50 DESNO	19,835
W110000090SIDV	3831020524552	WC KOLENO Z DVEMA GRLOMA IN TESNILOM/sivc	33,914
W110000090SIL	3831020501607	WC KOLENO110/90 ODCEP 50 LEVO	19,835
W110000090SIZ	3831020501614	WC KOLENO110/90 ODCEP 50 ZADAJ	19,835
W11045050-D	3831020531277	WC KOLENO 110/45 ODCEP 50 DESNO	19,836
W11045050DV	3831020531307	WC KOLENO 110/45° ODCEP 50 DVOJNI	33,913
W11045050-L	3831020531288	WC KOLENO 110/45/ODCEP 50 LEVO	19,836
W11045050-Z	3831020531291	WC KOLENO 110/45 ODCEP 50 ZADAJ	19,836

PVC KOLENO DVOJNO plastbrno

Koda	EAN	Naziv	Cena
CKT5000	8595156216280	PVC koleno dvojno 50	5,270

SIFONSKO KOLENO HTSW



Koda	EAN	Naziv	Cena
IL-K03200004600S	3831020524385	SIFONSKO KOLENO HTSW 32/46	5,861
IL-K04000004600S	3831020526945	SIFONSKO KOLENO HTSW 40/46	2,956
IL-K0400000460DS	3831020524422	SIFONSKO KOLENO HTSWL DOLGO 40/46	3,901
IL-K04000005000S	3831020524392	SIFONSKO KOLENO HTSW 40/50	3,320
IL-K0400000500DS	3831020524415	SIFONSKO KOLENO HTSWL DOLGO 40/50	3,901
IL-K05000005000S	3831020524408	SIFONSKO KOLENO HTSW 50/50	3,886
K03200004600S	3831020524385	SIFONSKO KOLENO HTSW 32/46	5,861
K04000004600S	3831020526945	SIFONSKO KOLENO HTSW 40/46	2,956
K0400000460DS	3831020524422	SIFONSKO KOLENO HTSWL DOLGO 40/46	3,901
K04000005000S	3831020524392	SIFONSKO KOLENO HTSW 40/50	3,320
K0400000500DS	3831020524415	SIFONSKO KOLENO HTSWL DOLGO 40/50	3,901
K05000005000S	3831020524408	SIFONSKO KOLENO HTSW 50/50	3,886

ODCEP ENOJNI REDUCIRANI HTEA

Koda	EAN	Naziv	Cena
O0500000450040	3831020501324	ODCEP HTEA 50/40/45°	3,317
O0500000670040	3831020519848	ODCEP HTEA 50/40/67°	5,946
O0500000870040	3831020501331	ODCEP HTEA 50/40/87°	3,715
O0750000450050	3831020501348	ODCEP HTEA 75/50/45°	3,508
O0750000670050	3831020508729	ODCEP HTEA 75/50/67°	5,684
O0750000870050	3831020501355	ODCEP HTEA 75/50/87°	3,508
O0900000450040	3831020526303	ODCEP HTEA 90/40/45°	7,448
O0900000450050	3831020526310	ODCEP HTEA 90/50/45°	6,464
O0900000450075	3831020526327	ODCEP HTEA 90/75/45°	5,883
O0900000870040	3831020511484	ODCEP HTEA 90/40/87,5°	7,448
O0900000870050	3831020526341	ODCEP HTEA 90/50/87°	6,464
O0900000870075	3831020526358	ODCEP HTEA 90/75/87°	5,882
O1100000450040	3831020500471	ODCEP HTEA 110/40/45°	9,095
O1100000450050	3831020501379	ODCEP HTEA 110/50/45°	4,488
O1100000450075	3831020501409	ODCEP HTEA 110/75/45°	6,072
O1100000450090	3831020523715	ODCEP HTEA 110/90/45°	28,047
O1100000670050AR	3831020500440	ODCEP HTEA 110/50/67,5°	4,468
O1100000670075	3831020508736	ODCEP HTEA 110/75/67°	7,826
O1100000870040	3831020500464	ODCEP HTEA 110/40/87°	4,375
O1100000870050	3831020501386	ODCEP HTEA 110/50/87°	4,450
O1100000870075	3831020501416	ODCEP HTEA 110/75/87°	6,072
O1100000870090	3831020523722	ODCEP HTEA 110/90/87°	28,049
O1250000450011	3831020501430	ODCEP HTEA 125/110/45°	13,954
O1250000450050	3831020519213	ODCEP HTEA 125/50/45°	26,316
O1250000450075	3831020519220	ODCEP HTEA 125/75/45°	27,465
O1250000870011	3831020501447	ODCEP HTEA 125/110/87°	13,954
O1250000870050	3831020531314	ODCEP HTEA 125/50/87°	26,316
O1250000870075	3831020519237	ODCEP HTEA 125/75/87°	27,465
O125V000450050	3831020519213	ODCEP HTEA 125/50/45°	26,316
O125V000870050	3831020531314	ODCEP HTEA 125/50/87°	26,316
O1600000450011	3831020501461	ODCEP HTEA 160/110/45°	19,891
O1600000450012	3831020501485	ODCEP HTEA 160/125/45°	22,116
O1600000450050	3831020528505	ODCEP HTEA 160/50/45°	30,004
O1600000450075	3831020531413	ODCEP HTEA 160/75/45°	30,225
O1600000870011	3831020501478	ODCEP HTEA 160/110/87°	19,891
O1600000870012	3831020501492	ODCEP HTEA 160/125/87°	22,116
O1600000870050	3831020531406	ODCEP HTEA 160/50/87°	30,004
O032000045	3831020501119	ODCEP HTEA 32/32/45°	2,187
O032000087	3831020501126	ODCEP HTEA 32/32/87°	2,207
O040000045	3831020501140	ODCEP HTEA 40/40/45°	2,055
O040000067ARGO	3831020500426	ODCEP HTEA 40/40/67,5°	2,150
O040000087	3831020501157	ODCEP HTEA 40/40/87°	2,055

ODCEP ENOJNI REDUCIRANI HTEA

Koda	EAN	Naziv	Cena
O050000045	3831020501171	ODCEP HTEA 50/50/45°	2,263
O050000067ARGO	3831020500433	ODCEP HTEA 50/50/67,5°	2,394
O050000087	3831020501188	ODCEP HTEA 50/50/87°	2,263
O075000045	3831020501201	ODCEP HTEA 75/75/45°	3,658
O075000067	3831020520103	ODCEP HTEA 75/75/67°	6,464
O075000087	3831020501218	ODCEP HTEA 75/75/87°	3,658
O090000045	3831020526297	ODCEP HTEA 90/90/45°	6,955
O090000087	3831020526334	ODCEP HTEA 90/90/87°	8,183
O110000045	3831020501232	ODCEP HTEA 110/110/45°	6,618
O11000006700AR	3831020500457	ODCEP HTEA 110/110/67,5°	7,166
O110000087	3831020501249	ODCEP HTEA 110/110/87°	6,618
O125000045	3831020501263	ODCEP HTEA 125/125/45°	13,954
O125000087	3831020501270	ODCEP HTEA 125/125/87°	13,954
O160000045	3831020501294	ODCEP HTEA 160/160/45°	23,305
O160000087	3831020501300	ODCEP HTEA 160/160/87°	23,305



PVC ODCEP ENOJNI GIBLJIVI 45°-87° plastbrno

Koda	EAN	Naziv	Cena
COK0556	8595156240667	PVC ODCEP ENOJNI GIBLJIVI-50/50 ; 45°-87°	7,879
COK0A56	8595156240674	PVC ODCEP ENOJNI GIBLJIVI-110/50 ; 45°-87°	10,198

ODCEP DVOJNI HTDA

Koda	EAN	Naziv	Cena
O05000004500D	3831020506701	ODCEP HTDA 50/50/50/45°	16,765
O05000006700D	3831020526266	ODCEP HTDA 50/50/50/67°	11,407
O05000008700D	3831020506718	ODCEP HTDA 50/50/50/87°	16,765
O07500004500D	3831020506749	ODCEP HTDA 75/75/75/45°	20,473
O07500004500DR50	3831020505902	ODCEP HTDA 75/50/50/45°	37,137
O07500008700D	3831020506756	ODCEP HTDA 75/75/75/87°	20,473
O07500008700DR50	3831020505919	ODCEP HTDA 75/50/50/87°	37,137
O0900000087D	3831020526280	ODCEP HTDA 90/90/90/87°	22,437
O09000004500D05	3831020518476	ODCEP HTDA 90/50/50/45°	19,006
O11000000670050D	3831020526952	ODCEP HTDA 110/50/50/67°	19,214
O1100000067D	3831020526365	ODCEP HTDA 110/110/110/67°	37,408
O11000004500075	3831020518407	ODCEP HTDA 110/75/75/45°	40,361
O11000004500D	3831020504202	ODCEP HTDA 110/110/110/45°	22,682
O11000004500DR50	3831020506794	ODCEP HTDA 110/50/50/45°	19,214
O11000006700DD	3831020500587	ODCEP KOTNI HTED 110/110/110/67°	40,015
O110000067DV	3831020526372	ODCEP HTDA 110/110/110/67°	37,408
O11000008700D50	3831020506855	ODCEP HTDA 110/50/50/87°	19,214
O110ARGO8700D	3831020518339	ODCEP HTDA 110/110/110/87° ARGO	22,682
O12500004500D	3831020518414	ODCEP HTDA 125/125/125/45°	90,643
O12500008700D	3831020518421	ODCEP HTDA 125/125/125/87°	90,643
O12500008700D11	3831020505926	ODCEP HTDA 125/110/110/87°	89,031
O16000004500D	3831020518452	ODCEP HTDA 160/160/160/45°	112,518
O16000004500DR11	3831020526518	ODCEP HTDA 160/110/110/45°	104,458
O16000008700D	3831020520172	ODCEP HTDA 160/160/160/87°	32,205

PVC ODCEP DVOJNI GIBLJIVI 45°-87° plastbrno

Koda	EAN	Naziv	Cena
COKA556	8595156240681	PVC ODCEP DVOJNI GIBLJIVI DN110/50/50 ; 45°-87°	14,151

WC PRIKLJUČEK S TESNILOM

Koda	EAN	Naziv	Cena
W11000000000P	3856015901699	WC PRIKLJUČEK S TESNILOM HTSK 110/130	25,123



ČISTILNI KOS HTRE

Koda	EAN	Naziv	Cena
CC0500000000K	3831020502062	ČISTILNI KOS HTRE 50	3,771
CC0750000000K	3831020502079	ČISTILNI KOS HTRE 75	4,996
CC0900000000K	3831020525627	ČISTILNI KOS HTRE 90	12,090
CC1100000000K	3831020502086	ČISTILNI KOS HTRE 110	6,957
CC1250000000K	3831020502093	ČISTILNI KOS HTRE 125	17,610
CC1600000000K	3831020502109	ČISTILNI KOS HTRE 160	24,643



PVC PREHOD NA LITINO plastbrno

Koda	EAN	Naziv	Cena
CL50001	8595156224056	PVC PREHOD NA LITINO DN50 - 72/121	1,839
CL70001	8595156224063	PVC PREHOD NA LITINO DN75 - 97/127	1,921
CLA0001	8595156224094	PVC PREHOD NA LITINO DN110 - 124/141	2,741



PVC REDUCIRKA NIZKA GIBLJIVA 3°- 40° plastbrno

Koda	EAN	Naziv	Cena
COKRA56	8595156242418	PVC REDUCIRKA NIZKA GIBLJIVA 110/50, 3°- 40°	7,879



PVC GRLENA SPOJKA M/Ž plastbrno

Koda	EAN	Naziv	Cena
CRPAA00	8595156227118	PVC HTSM GRLENA SPOJKA M/Ž-110/110	5,300
CRP5500	8595156273566	PVC HTSM GRLENA SPOJKA GLOBOKA 50/50 M/Ž	4,099



Koda	EAN	Naziv	Cena
CRPCA00	8595156228306	PVC HTSM GRLENA SPOJKA M/Ž-125/110	5,534
CRPGA00	8595156229556	PVC HTSM GRLENA SPOJKA M/Ž-160/110	22,136



Koda	EAN	Naziv	Cena
CRPAA01	8595156240735	PVC KGSM GRLENA SPOJKA M/Ž-110/110	6,787
CRPCA01	8595156240742	PVC KGSM GRLENA SPOJKA M/Ž-125/110	10,845



DRSNA SPOJKA HTU

Koda	EAN	Naziv	Cena
D032	3831020502123	DRSNA SPOJKA HTU 32	1,564
D040	3831020502130	DRSNA SPOJKA HTU 40	1,564
D050	3831020502147	DRSNA SPOJKA HTU 50	1,640
D075	3831020502154	DRSNA SPOJKA HTU 75	2,545
D090	3831020523241	DRSNA SPOJKA HTU 90	4,710
D110	3831020502161	DRSNA SPOJKA HTU 110	3,865
D125	3831020502178	DRSNA SPOJKA HTU 125	8,523
D160	3831020502192	DRSNA SPOJKA HTU 160	12,934



SPOJKA Z DVOJNIM GRLOM

Koda	EAN	Naziv	Cena
D032ABOX0000DG	3831020523074	SPOJKA HTMM 32 Z DVOJNIM GRLOM ARG0	1,564
D040ABOX0000DG	3831020523319	SPOJKA HTMM 40 Z DVOJNIM GRLOM ARG0	1,564
D050ABOX0000DG	3831020523142	SPOJKA HTMM 50 Z DVOJNIM GRLOM ARG0	1,640
D075ABOX0000DG	3831020523159	SPOJKA HTMM 75 Z DVOJNIM GRLOM ARG0	2,545
D110ABOX0000DG	3831020523135	SPOJKA HTMM 110 Z DVOJNIM GRLOM ARG0	3,869
D125ABOX0000DG	3831020515499	SPOJKA HTMM 125 Z DVOJNIM GRLOM ARG0	8,522
D160ABOX0000DG	3831020515505	SPOJKA HTMM 160 Z DVOJNIM GRLOM ARG0	12,935



SPOJKE S TROJNO GLOBINO GRLA HTLL

Koda	EAN	Naziv	Cena
S040	3831020500266	SPOJKA 3X GLOBINA GRLA HTLL 40	5,892
S050	3831020500273	SPOJKA 3X GLOBINA GRLA HTLL 50	6,271
S075	3831020500280	SPOJKA 3X GLOBINA GRLA HTLL 75	10,030
S090	3831020527027	SPOJKA 3X GLOBINA GRLA HTLL 90	7,499
S110	3831020500297	SPOJKA 3X GLOBINA GRLA HTLL 110	13,620
S125L	3831020520537	SPOJKA 3X GLOBINA GRLA HTLL 125	17,670
S160L	3831020522985	SPOJKA 3X GLOBINA GRLA HTLL 160	26,583



PREHODNI KOS HTR

Koda	EAN	Naziv	Cena
P040000000032	3831020501898	R-KOS HTR 40/32	1,320
P040000000032K	3831020500563	R-KOS HTR-KRATKA 40/32	1,321
P040000000032R	3831020508941	R-KOS HTRR 40/32	2,829
P0400000000050	3831020508958	R-KOS HTRR 40/50	3,653
P0500000000032	3831020501904	R-KOS HTR 50/32	1,320
P0500000000040	3831020501911	R-KOS HTR 50/40	1,320
P0500000000040K	3831020500570	R-KOS HTR-KRATKA 50/40	1,321
P0750000000050	3831020501928	R-KOS HTR 75/50	1,848
P075000000040K	3831020520544	R-KOS HTR-KRATKA 75/40	4,601
P075000000050K	3831020526617	R-KOS HTR-KRATKA 75/50	4,600
P0900000000040	3831020500334	R-KOS HTR-KRATKA 90/40	2,921
P0900000000050	3831020526648	R-KOS HTR-KRATKA 90/50	2,920
P0900000000075	3831020527232	R-KOS HTR-KRATKA 90/75	4,311
P10000000000110	3831020501065	PREHODNI KOS PVC/PP 100/110	7,221
P11000000000050	3831020501942	R-KOS HTR 110/50	2,620
P1100000000050V	3831020508927	R-KOS HTR-KRATKA 110/50	3,811
P1100000000075	3831020501959	R-KOS HTR 110/75	2,620
P1100000000075V	3831020522237	R-KOS HTR-KRATKA 110/75	3,754
P1100000000090	3831020526655	R-KOS HTR-KRATKA 110/90	4,352
P1100000000090R	3831020512030	R-KOS HTRR 110/90	24,503
P11010000000R	8023857138230	R-KOS HTR 110/100 R	10,156
P12500000000050	3831020522343	R-KOS HTR 125/50	13,670
P12500000000075T	3831020511309	R-KOS HTR 125/75	10,306
P12500000000110	3831020501980	R-KOS HTR 125/110	3,940
P12500000000110K	3831020505216	R-KOS HTR-KRATKA 125/110	7,682
P16000000000110	3831020502017	R-KOS HTR 160/110	5,864
P16000000000125	3831020502024	R-KOS HTR 160/125	6,316
P16000000110K	8023857034815	R-KOS HTR-KRATKA 160/110	19,065



ČEP HTM

Koda	EAN	Naziv	Cena
CC032	3831020502482	ČEP HTM 32	0,679
CC040	3831020502253	ČEP HTM 40	0,679
CC050	3831020502260	ČEP HTM 50	0,679
CC075	3831020502277	ČEP HTM 75	1,038
CC090	3831020525610	ČEP HTM 90	3,204
CC110	3831020502284	ČEP HTM 110	1,245
CC125	3831020502291	ČEP HTM 125	1,772
CC160	3831020502307	ČEP HTM 160	2,602



PVC PROTISMRAJNA KAPA PB plastbrno

Koda	EAN	Naziv	Cena
AVP4000	8595156222397	PVC PROTISMRAJNA KAPA 40	6,852
AVP5000	8595156222403	PVC PROTISMRAJNA KAPA 50	6,588
AVP7000	8595156222427	PVC PROTISMRAJNA KAPA 75	8,520
AVPA000	8595156222380	PVC PROTISMRAJNA KAPA 110	26,059





ODZRAČEVALNA KAPA PP

Koda	EAN	Naziv	Cena
O05000000000K	3831020502215	ODZRAČEVALNA KAPA KADH 50 KRATKA	14,462
O05000000000KD	3831020509009	ODZRAČEVALNA KAPA KADH 50 DOLGA	14,462
O07500000000K	3831020502222	ODZRAČEVALNA KAPA KADH 75 KRATKA	14,462
O07500000000KD	3831020509016	ODZRAČEVALNA KAPA KADH 75 DOLGA	14,462
O11000000000K	3831020502239	ODZRAČEVALNA KAPA KADH 110 KRATKA	20,137
O11000000000KD	3831020509023	ODZRAČEVALNA KAPA KADH 110 DOLGA	20,137
O12500000000ARGO	3831020508989	ODZRAČEVALNA KAPA KADH 125 ARGO	34,898
O16000000000ARGO	3831020508996	ODZRAČEVALNA KAPA KADH 160 ARGO	43,092



PVC ČEP S PRIKLJUČKOM za gumi cev - koleno plastbrno

Koda	EAN	Naziv	Cena
UZ30R00	8595156262522	PVC ČEP S PRIKLJUČKOM 30-kolenski 19-21mm	5,124
UZ40R00	8595156243194	PVC ČEP S PRIKLJUČKOM 40-kolenski 19-21mm	5,124
UZ50R00	8595156242449	PVC ČEP S PRIKLJUČKOM 50-kolenski 19-21mm	5,124

PVC ČEP S PRIKLJUČKOM za gumi cev - ravni plastbrno

Koda	EAN	Naziv	Cena
UZ30000	8595156242944	PVC ČEP S PRIKLJUČKOM 30-ravni 8-25mm	5,124
UZ40000	8595156243187	PVC ČEP S PRIKLJUČKOM 40-ravni 8-25mm	5,124
UZ50000	8595156242432	PVC ČEP S PRIKLJUČKOM 50-ravni 8-25mm	5,124



PVC REDUCIRKA S PRIKLJUČKOM za gumi cev - ravna plastbrno

Koda	EAN	Naziv	Cena
UZH0002	8595156203020	PVC reducirka s priključkom za gumi cev ravna	26,088

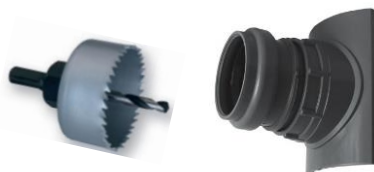

PVC NAVRTALNI OKLEP plastbrno

Koda	EAN	Naziv	Cena
COS0A48	8595156228450	PVC NAVRTALNI OKLEP-110/40	20,806
COS0A58	8595156227132	PVC NAVRTALNI OKLEP-110/50	20,806
COS0C58	8595156242166	PVC NAVRTALNI OKLEP-125/50	20,806
COS0000	8595156227125	Navrtalna krona 110/50	17,129

TESNILA

Koda	EAN	Naziv	Cena
L032	3831020502314	TESNILO LABIRINT BL 32	0,191
L040	3831020502352	TESNILO LABIRINT BL 40	0,191
L050	3831020502369	TESNILO LABIRINT BL 50	0,191
L075	3831020502376	TESNILO LABIRINT BL 75	0,266
L090	3831020527829	TESNILO LABIRINT BL 90	0,412
L110	3831020502383	TESNILO LABIRINT BL 110	0,412
L125	3831020502390	TESNILO LABIRINT BL 125	0,751
L160	3831020502406	TESNILO LABIRINT BL 160	0,913
T046T000000000	3831020529984	TESNILO SIFONSKO DL 46/40 T	1,888
T047T000000000	3831020529991	TESNILO SIFONSKO DL 47/32 T	1,888
T050T000000032	3831020530010	TESNILO SIFONSKO DL 50/32 T	2,689
T050T000000040	3831020530003	TESNILO SIFONSKO DL 50/40 T	2,689
W03	3831020502734	TESNILO WC ART.03 110	17,631
W04	3831020502741	TESNILO WC ART.04 110	17,631
W11000000000U	3831020502727	TESNILO WC UNIVERZAL 110	17,631



MAST

Koda	EAN	Naziv	Cena
M2000	3831020517950	MAST MGN 2000g	20,256
M250	3831020502796	MAST MGN 250 g	8,799

KANALIZACIJSKA CEV US PP nizkošumna

Koda	EAN	Naziv	Cena
C032US0150	7290107762540	USEM silent cev 1 32 L-150	0,898
C032US0250	7290107760959	USEM silent cev 1 32 L-250	1,143
C032US0500	7290107760966	USEM silent cev 1 32 L-500	1,758
C032US1000	7290107760973	USEM silent cev 1 32 L-1000	2,987
C032US1500	7290107760980	USEM silent cev 1 32 L-1500	4,217
C032US2000	7290107760997	USEM silent cev 1 32 L-2000	5,444
C032US3000	7290107761000	USEM silent cev 1 32 L-3000	7,902
C040US0150	7290107761062	USEM silent cev 1 40 L-150	1,028
C040US0250	7290107761079	USEM silent cev 1 40 L-250	1,338
C040US0500	7290107761086	USEM silent cev 1 40 L-500	2,114
C040US1000	7290107761093	USEM silent cev 1 40 L-1000	3,668
C040US1500	7290107761109	USEM silent cev 1 40 L-1500	5,220
C040US2000	7290107761116	USEM silent cev 1 40 L-2000	6,773
C040US3000	7290107761123	USEM silent cev 1 40 L-3000	9,879
C050US0150	7290107760089	USEM silent cev 1 50 L-150	1,229
C050US0250	7290107760096	USEM silent cev 1 50 L-250	1,621
C050US0500	7290107760102	USEM silent cev 1 50 L-500	2,599
C050US1000	7290107760119	USEM silent cev 1 50 L-1000	4,558
C050US1500	7290107760126	USEM silent cev 1 50 L-1500	6,516
C050US2000	7290107760133	USEM silent cev 1 50 L-2000	8,475
C050US3000	7290107762281	USEM silent cev 1 50 L-3000	12,390
C075US0150	7290107760140	USEM silent cev 1 75 L-150	2,051
C075US0250	7290107760157	USEM silent cev 1 75 L-250	2,834
C075US0500	7290107760164	USEM silent cev 1 75 L-500	4,793
C075US1000	7290107760171	USEM silent cev 1 75 L-1000	8,709
C075US1500	7290107760188	USEM silent cev 1 75 L-1500	12,625
C075US2000	7290107760195	USEM silent cev 1 75 L-2000	16,541
C075US3000	7290107760201	USEM silent cev 1 75 L-3000	24,373
C090US0150	7290107762274	USEM silent cev 1 90 L-150	3,142
C090US0250	7290107761284	USEM silent cev 1 90 L-250	4,311
C090US0500	7290107761291	USEM silent cev 1 90 L-500	7,235
C090US1000	7290107761307	USEM silent cev 1 90 L-1000	13,082
C090US1500	7290107761314	USEM silent cev 1 90 L-1500	18,930
C090US2000	7290107761321	USEM silent cev 1 90 L-2000	24,777
C090US3000	7290107761338	USEM silent cev 1 90 L-3000	36,472
C110US0150	7290107760010	USEM silent cev 1 110 L-150	4,820
C110US0250	7290107760027	USEM silent cev 1 110 L-250	6,673
C110US0500	7290107760034	USEM silent cev 1 110 L-500	11,299
C110US1000	7290107760041	USEM silent cev 1 110 L-1000	20,550
C110US1500	7290107760058	USEM silent cev 1 110 L-1500	29,801
C110US2000	7290107760065	USEM silent cev 1 110 L-2000	39,051
C110US3000	7290107760072	USEM silent cev 1 110 L-3000	57,554
C125US0150	7290107762472	USEM silent cev 1 125 L-150	5,911
C125US0250	7290107760799	USEM silent cev 1 125 L-250	8,233
C125US0500	7290107760805	USEM silent cev 1 125 L-500	14,040
C125US1000	7290107760812	USEM silent cev 1 125 L-1000	25,654
C125US1500	7290107760829	USEM silent cev 1 125 L-1500	37,269
C125US2000	7290107760836	USEM silent cev 1 125 L-2000	48,881
C125US3000	7290107760843	USEM silent cev 1 125 L-3000	72,109
C160US0150	7290107762403	USEM silent cev 1 160 L-150	9,579
C160US0250	7290107762434	USEM silent cev 1 160 L-250	13,334
C160US0500	7290107760904	USEM silent cev 1 160 L-500	22,720
C160US1000	7290107760911	USEM silent cev 1 160 L-1000	41,490
C160US1500	7290107760928	USEM silent cev 1 160 L-1500	60,261
C160US2000	7290107760935	USEM silent cev 1 160 L-2000	79,031
C160US3000	7290107760942	USEM silent cev 1 160 L-3000	116,574
C200USH1000	7290107763387	USEM silent cev 1 200 L-1000	97,183
C200USH3000	7290107763370	USEM silent cev 1 200 L-3000	273,095



KOLENO USB nizkošumno

Koda	EAN	Naziv	Cena
K032US15	7290107761567	USB koleno 32/15°	2,462
K032US30	7290107761574	USB koleno 32/30°	2,462
K032US45	7290107761581	USB koleno 32/45°	2,462
K032US67	7290107761598	USB koleno 32/67°	2,671
K032US87	7290107761604	USB koleno 32/87°	2,671
K040US15	7290107761611	USB koleno 40/15°	2,462
K040US30	7290107761628	USB koleno 40/30°	2,462
K040US45	7290107761635	USB koleno 40/45°	2,462
K040US67	7290107761642	USB koleno 40/67°	2,671
K040US87	7290107761659	USB koleno 40/87°	2,671
K050US15	7290107760218	USB koleno 50/15°	2,671
K050US30	7290107760225	USB koleno 50/30°	2,671
K050US45	7290107760232	USB koleno 50/45°	2,671
K050US67	7290107761666	USB koleno 50/67°	2,671
K050US87	7290107760249	USB koleno 50/87°	2,671
K075US15	7290107760256	USB koleno 75/15°	4,079
K075US30	7290107760263	USB koleno 75/30°	4,079
K075US45	7290107760270	USB koleno 75/45°	4,079
K075US67	7290107760287	USB koleno 75/67°	4,495
K075US87	7290107760294	USB koleno 75/87°	4,495
K090US15	7290107761765	USB koleno 90/15°	5,741
K090US30	7290107761772	USB koleno 90/30°	5,741
K090US45	7290107761789	USB koleno 90/45°	5,741
K090US67	7290107761796	USB koleno 90/67°	6,514
K090US87	7290107761802	USB koleno 90/87°	6,514
K110US15	7290107760300	USB koleno 110/15°	6,259
K110US30	7290107760317	USB koleno 110/30°	6,259
K110US45	7290107760324	USB koleno 110/45°	6,259
K110US67	7290107760331	USB koleno 110/67°	7,104
K110US87	7290107760348	USB koleno 110/87°	7,104
K125US15	7290107761673	USB koleno 125/15°	11,662
K125US30	7290107761680	USB koleno 125/30°	11,662
K125US45	7290107761697	USB koleno 125/45°	11,662
K125US67	7290107761703	USB koleno 125/67°	16,084
K125US87	7290107761710	USB koleno 125/87°	16,084
K160US16	7290107761727	USB koleno 160/15°	19,122
K160US31	7290107761734	USB koleno 160/30°	19,122
K160US46	7290107761741	USB koleno 160/45°	19,122
K160US87	7290107761758	USB koleno 160/87°	32,902
K200US45	7290107762304	USB koleno 200/45°	33,107

SIFONSKO KOLENO USSW nizkošumno

Koda	EAN	Naziv	Cena
IL-K032US0460HU	7290107762175	USSW sifonsko koleno 32/46	7,166
IL-K040US0460HU	7290107762182	USSW sifonsko koleno 40/46	6,113
IL-K040US0500HU	7290107762205	USSW sifonsko koleno 40/50	6,113
IL-K050US0500HU	7290107762229	USSW sifonsko koleno 50/50	6,113
IL-KD040US0460HU	7290107762199	USSWL sifonsko koleno dolgo 40/46	7,722
IL-KD040US0500HU	7290107762212	USSWL sifonsko koleno dolgo 40/50	7,722
K032US0460HU	7290107762175	USSW sifonsko koleno 32/46	7,166
K040US0460HU	7290107762182	USSW sifonsko koleno 40/46	6,113
K040US0500HU	7290107762205	USSW sifonsko koleno 40/50	6,113
K050US0500HU	7290107762229	USSW sifonsko koleno 50/50	6,113
KD040US0460HU	7290107762199	USSWL sifonsko koleno dolgo 40/46	7,722
KD040US0500HU	7290107762212	USSWL sifonsko koleno dolgo 40/50	7,722
W090USLONG	7290107762830	USSBL WC koleno dolgo 90	6,091
W110USLONG	7290107762762	USSBL WC koleno dolgo 110	6,266

ČISTILNI KOS USRE nizkošumni

Koda	EAN	Naziv	Cena
CC050US0000K	7290107762236	USRE čistilni kos 50	8,440
CC075US0000K	7290107760720	USRE čistilni kos 75	11,368
CC090US0000K	7290107762250	USRE čistilni kos 90	14,087
CC110US0000K	7290107760737	USRE čistilni kos 110	15,312
CC125US0000K	7290107762892	USRE čistilni kos 125	40,423
CC160US0000K	7290107762847	USRE čistilni kos 160	65,879
CC200US0000K	7290107763363	USRE čistilni kos 200	187,145



ODCEP USEA nizkošumni

Koda	EAN	Naziv	Cena
O032US0045	7290107761819	USEA odcep 32/32/45°	4,777
O032US0087	7290107762885	USEA odcep 32/32/87°	4,880
O040US0045	7290107761826	USEA odcep 40/40/45°	5,133
O040US0087	7290107761833	USEA odcep 40/40/87°	5,133
O050US0045	7290107760355	USEA odcep 50/50/45°	6,113
O050US0087	7290107760362	USEA odcep 50/50/87°	6,113
O050US450040	7290107761840	USEA odcep 50/40/45°	6,113
O050US870040	7290107761857	USEA odcep 50/40/87°	6,113
O075US0045	7290107760393	USEA odcep 75/75/45°	6,749
O075US0087	7290107760409	USEA odcep 75/75/87°	6,749
O075US450050	7290107760379	USEA odcep 75/50/45°	6,749
O075US870050	7290107760386	USEA odcep 75/50/87°	6,749
O090US0045	7290107761895	USEA odcep 90/90/45°	12,674
O090US450040	7290107762984	USEA odcep 90/40/45°	12,663
O090US450050	7290107761871	USEA odcep 90/50/45°	12,674
O090US870050	7290107761888	USEA odcep 90/50/87°	12,597
O110US0045	7290107760447	USEA odcep 110/110/45°	13,843
O110US450040	7290107762960	USEA odcep 110/40/45°	13,828
O110US450050	7290107760416	USEA odcep 110/50/45°	13,843
O110US450075	7290107760430	USEA odcep 110/75/45°	13,843
O110US450090	7290107762977	USEA odcep 110/90/45°	13,828
O110US870050	7290107760423	USEA odcep 110/50/87°	13,843
O125US0045	7290107760478	USEA odcep 125/125/45°	53,482
O125US0087	7290107761864	USEA odcep 125/125/87°	39,118
O125US450110	7290107760454	USEA odcep 125/110/45°	31,714
O160US0045	7290107760508	USEA odcep 160/160/45°	101,073
O160US0087	7290107760501	USEA odcep 160/160/87°	81,876
O160US450110	7290107760485	USEA odcep 160/110/45°	57,291
O200US450160	7290107762489	USEA odcep 200/160/45°	236,219
O200US450200	7290107762496	USEA odcep 200/200/45°	307,085

ODCEP DVOJNI USEA nizkošumni

Koda	EAN	Naziv	Cena
O110US6700D	7290107760744	USDA odcep dvojni 110/110/110/67°	27,984
O110US6750D	7290107760546	USDA odcep dvojni 110/50/50/67°	24,806
O110US8700D	7290107763417	USDA odcep dvojni 110/110/110/87°	26,646
O110US8750D	7290107767620	USDA odcep dvojni 110/50/50/87°	52,825

ODCEP KOTNI USED nizkošumni

Koda	EAN	Naziv	Cena
O110US8700DD	7290107761925	USED odcep kotni 110/110/110/87°	51,122
O125US8700DD	7290107761932	USED odcep kotni 125/110/110/87°	59,887

ODCEP US nizkošumni

Koda	EAN	Naziv	Cena
O090US0087S	7290107761918	US odcep swept 90/90/87°	14,496
O110US0087S	7290107760539	US odcep swept 110/110/87°	14,496
O110US870075S	7290107760522	US odcep swept 110/75/87°	14,496
O110US870090S	7290107761901	US odcep swept 110/90/87°	14,496
O125US8700110S	7290107760461	US odcep swept 125/110/87°	31,715
O160US8700110S	7290107760492	US odcep swept 160/110/87°	50,959

SIFONSKI PRIKLJUČEK USS nizkošumni

Koda	EAN	Naziv	Cena
IL-P032US00046	7290107762854	USS priključek sifonski 32/46	0,348
IL-P040US00046	7290107762861	USS priključek sifonski 40/46	0,523
IL-P040US00050	7290107762878	USS priključek sifonski 40/50	0,160
P032US00046	7290107762854	USS priključek sifonski 32/46	0,348
P040US00046	7290107762861	USS priključek sifonski 40/46	0,523
P040US00050	7290107762878	USS priključek sifonski 40/50	0,160

PREHODNI KOS USR nizkošumni

Koda	EAN	Naziv	Cena
P040US000032	7290107762052	USR prehodni kos 32/40	3,651
P050US000032	7290107760652	USR prehodni kos 32/50	3,651
P050US000040	7290107760669	USR prehodni kos 40/50	3,651
P075US000050	7290107760676	USR prehodni kos 50/75	3,945
P090US000040	7290107762090	USR prehodni kos 40/90	3,945
P090US000050	7290107762106	USR prehodni kos 50/90	5,844
P090US000075	7290107762953	USR prehodni kos 75/90	5,843
P110US000040	7290107762946	USR prehodni kos 40/110	5,838
P110US000050	7290107760683	USR prehodni kos 50/110	5,843
P110US000075	7290107760690	USR prehodni kos 75/110	5,843
P110US000090	7290107762069	USR prehodni kos 90/110	11,122
P125US0000110	7290107762076	USR prehodni kos 110/125	11,122
P160US0000110	7290107760706	USR prehodni kos 110/160	16,795
P160US0000125	7290107762083	USR prehodni kos 125/160	16,795
P200US0000160	7290107762571	USR prehodni kos 160/200	122,933



DRSNA SPOJKA USU nizkošumna

Koda	EAN	Naziv	Cena
D032US	7290107763684	USU drsna spojka 32	3,100
D040US	7290107761994	USU drsna spojka 40	3,307
D050US	7290107760577	USU drsna spojka 50	3,651
D075US	7290107760591	USU drsna spojka 75	4,643
D090US	7290107762038	USU drsna spojka 90	8,249
D110US	7290107760614	USU drsna spojka 110	8,084
D125US	7290107762014	USU drsna spojka 125	15,177
D160US	7290107760638	USU drsna spojka 160	22,368
D200US	7290107762557	USU drsna spojka 200	94,772



DRSNA SPOJKA USMM nizkošumna

Koda	EAN	Naziv	Cena
D032US0000DG	7290107761987	USMM drsna spojka dvojna 32	3,100
D040US0000DG	7290107762007	USMM drsna spojka dvojna 40	3,307
D050US0000DG	7290107760584	USMM drsna spojka dvojna 50	3,651
D075US0000DG	7290107760607	USMM drsna spojka dvojna 75	4,643
D090US0000DG	7290107762045	USMM drsna spojka dvojna 90	8,249
D110USN000DG	7290107763660	USMM drsna spojka dvojna 110 n	8,084
D125US0000DG	7290107762021	USMM drsna spojka dvojna 125	15,177
D160US0000DG	7290107760645	USMM drsna spojka dvojna 160	22,368
D200US0000DG	7290107763561	USMM drsna spojka dvojna 200	94,772



SPOJKA PODALJŠANA USLL nizkošumna

Koda	EAN	Naziv	Cena
S040US	7290107762113	USLL spojka podaljšana 40	3,651
S050US	7290107762120	USLL spojka podaljšana 50	4,777
S075US	7290107762137	USLL spojka podaljšana 75	6,749
S090US	7290107762168	USLL spojka podaljšana 90	9,681
S110US	7290107760713	USLL spojka podaljšana 110	10,890
S125US	7290107762144	USLL spojka podaljšana 125	14,768
S160US	7290107762151	USLL spojka podaljšana 160	25,024



ČEP USM nizkošumni

Koda	EAN	Naziv	Cena
CC040US	7290107761949	USM čep 40	2,108
CC050US	7290107762267	USM čep 50	2,952
CC075US	7290107760553	USM čep 75	3,651
CC090US	7290107761970	USM čep 90	7,541
CC110US	7290107760560	USM čep 110	7,938
CC125US	7290107761956	USM čep 125	10,179
CC160US	7290107761963	USM čep 160	12,667
CC200US	7290107766579	USM čep 200	24,304



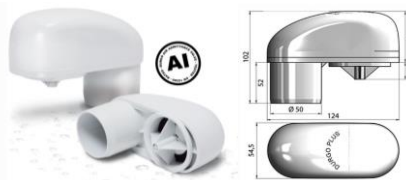

PREZRAČEVALNI VENTIL DN50 za notranjo vgradnjo

Koda	EAN	Naziv	Cena
7000.055	7392948310536	DURGO Podometni prezračevalni ventil DN50	84,90

*Po naročilu

Prezračevalni ventil za kanalizacijske cevi preprečuje širjenje smradu iz odtočnega sifona. V primeru podtlaka se odpre in omogoči dotok zraka v cev. Vgradi se na vrhu vertikale za odpadno vodo npr. na podstrehi, v votli steni, v spuščnem stropu ali pod umivalnikom. Mikroporna membrana je popolnoma tesna in zapre pot vsem vonjavam. Pretok: 19 l/s dovoda zraka pri podtlaku 2,5 mbar. Testirano in odobreno v skladu z EN 12380. Primerno za do 4 kopalnice. Zasnovan za namestitvev pod 5 cm širine.

10 let garancije na vse izdelke !



PREZRAČEVALNI VENTIL DN110 za notranjo vgradnjo

Koda	EAN	Naziv	Cena
7000.050	7392948310505	DURGO Prezračevalni ventil DN50	76,92
7000.110	7392948311106	DURGO Prezračevalni ventil DN110	108,95

DN	z izolacijo		z izolacijo		Razred	l/s*	Uporaba
	D(mm)	H(mm)	D(mm)	H(mm)			
DN15 z zunanjim navojem	54	48	/	/	A1	3,0	sifon
DN50	84	98	120	120	A1	17,0	do 4 kopalnice
DN110	140	120	180	147	A1	44,2	6 do 12 kopalnic
A1	Možna je namestitvev pod nivojem povratnega toka. Temperaturno območje -20°C do +60°C.						
A2	Montaža možna samo nad nivojem povratnega toka. Temperaturno območje -20°C do +60°C.						
l/s*	Izmerjena prostornina dotoka zraka po DIN EN 12380 v litrih /s pri -2,5 milibara (-250 Pa) podtlaka v sistemu. Največja vrednost dotoka zraka prezračevalnega ventila ustreza 95 % priključenega dimenzioniranja.						



PREZRAČEVALNI VENTIL DN15 na sifonskem kolenu / cevi - notranji navoj

Koda	EAN	Naziv	Cena
7300.015	4260387822206	DURGO Sifonsko koleno DN32-250-90°, odduh 1/2"	67,10
7310.015	4260387822305	DURGO Sifonska cev DN32-250, odduh 1/2"	62,22



PODOMETNE OMARICE za prezračevalni ventil

Koda	EAN	Naziv	Cena
7900.000	4260387829977	DURGO Podometna omarica PREMIUM brez pokrova, prezračevalni ventil DN50	132,98

Koda	EAN	Naziv	Cena
7900.055	4260387829991	DURGO Podometna omarica PREMIUM bela s pokrovom, prezračevalni ventil DN50	211,06

Vgradnja v steno z držali
Magneti na omarici

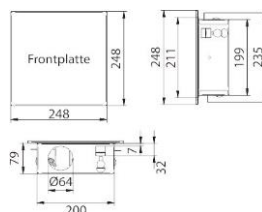

Koda	EAN	Naziv	Cena
7550.000	4260387825559	DURGO Podometna omarica BASIC s prezračevalnim ventilom DN50	169,58

Pokrov absorbira zvok.

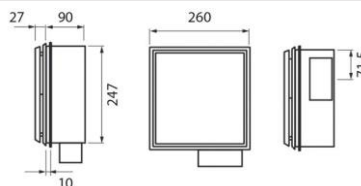

Koda	EAN	Naziv	Cena
7900.400	4260387829939	DURGO Vrataca z zapahom bela za PREMIUM	114,12

Koda	EAN	Naziv	Cena
7900.700	4260387829960	DURGO Pokrov za vgradnjo ploščic, okvir inox mat, odduh PREMIUM	177,84





*Odprodaja

WC MANŠETE

Koda	EAN	Naziv	Pakiranje	Cena
MCP0000*	8595156243101	Manšeta wc PVC gumi ravna	1	4,319
MEP2000*	8595156243118	Manšeta wc PVC gumi ekscenter	1	4,477
MCS0000*	8595156222526	Manšeta wc PVC ravna 110 bela	1	2,574
MES0000*	8595156223776	Manšeta wc PVC ekscenter 110 bela	1	2,574



WC PRIKLJUČNE CEVI

Koda	EAN	Naziv	Pakiranje	Cena
IL25000	8595156222663	Wc priključek gibljivi 250-450mm	15	10,365
IL32000	8595156222687	Wc priključek gibljivi 320-540mm	15	14,083
KR00000	8595156224049	WC rozeta 110mm PVC	20	1,874



PRIKLJUČNE PVC CEVI

Koda	EAN	Naziv	Pakiranje	Cena
EV20000	8595156209336	Koleno 45° DN 40/50	1	2,167



GSP5400	8595156226296	Gibljiva cev 5/4" max.dolžina 850mm, DN 32/40	50	2,281
----------------	---------------	--	----	--------------



GSP6500	8595156226302	Gibljiva cev 6/4" max.dolžina 950mm, DN 40/50	40	2,501
----------------	---------------	--	----	--------------



GP-0129*	8606009613184	Gibljiva cev kratka Ø40 dolž.60cm NVM		2,379
-----------------	---------------	--	--	--------------



GP-0132*	8606009611203	Gibljiva cev srednja Ø40 dolž.110cm NVM		4,026
-----------------	---------------	--	--	--------------



GP-0128*	8606009611180	Gibljiva cev dolga Ø40 dolž.160cm NVM		5,429
-----------------	---------------	--	--	--------------

SIFONSKA GUMI MANŠETA

Koda	EAN	Naziv	Pakiranje	Cena
CG44C00	8595156226555	Sifonska gumi manšeta 50-40	20	0,964
CG43B00	8595156226548	Sifonska gumi manšeta 50-30	20	1,025
CG43A00	8595156223363	Sifonska gumi manšeta 40-32	20	0,964



TEFLONSKI TRAK

Koda	EAN	Naziv	Pakiranje	Cena
WT12000	8595156203099	Teflon trak 12 x 0,1 x 10mm PB	100	0,622
WT19000	8595156203105	Teflon trak 19 x 0,2 x 15mm PB	70	2,989



ŽICA ZA ČIŠČENJE ODTOKOV

Koda	EAN	Naziv	Pakiranje	Cena
TG-7615*	8606009613474	Žica za čiščenje odtokov Ø8 x 6m		19,764
TG-7616*		Žica za čiščenje odtokov Ø8 x 8m		26,352
TG-0482*		Žica za čiščenje odtokov Ø8 x 10m		32,940
TG-0693*		Žica za čiščenje odtokov Ø10 x 8m		34,587
TG-0483*		Žica za čiščenje odtokov Ø10 x 10m		43,646
TG-765		Žica za čiščenje odtokov Ø10 x 12m		52,375



MAST ZA PLASTIKO

Koda	EAN	Naziv	Pakiranje	Cena
WM25010	8595156227460	Mast za plastiko 250 g	50	3,135



SIFONI ZA UMIVALNIK



Koda	EMCR001	EMCR002	EMCR003	EMCR004
EAN	8595156227033	8595156227040	8595156227057	8595156227064
Naziv	Sifon za umivalnik bučka S 5/4", DN32	Sifon za umivalnik lok, S 5/4", DN32	Sifon za umivalnik okrogli S 5/4", DN32	Sifon za umivalnik QUADRO S 5/4", DN32
Cena	26,93	23,45	50,86	64,32



Koda	EMCP001	EMCP002	EMCP003	EMCP004
EAN				
Naziv	Sifon za umivalnik Poseidon plastic, krom, S5/4", DN32	Sifon za umivalnik Poseidon plastic, bel, S5/4", DN32	Sifon za umivalnik Poseidon plastic, mat bel, S5/4", DN32	Sifon za umivalnik Poseidon plastic, mat črn, S5/4", DN32
Cena	40,48	23,47	55,09	55,09

KLIK-KLAK SIFONI



Koda	EUVCR01	EUVCR02	EUVCR05	EUVCP01	EUVCP02	EUVCP03	EUVCP04
EAN	8595156224025	8595156224032	8595156230484				
Naziv	KLIK-KLAK kratki	KLIK-KLAK dolgi	KLIK-KLAK KVADRO	KLIK-KLAK kratki PVC krom	KLIK-KLAK kratki PVC inox	KLIK-KLAK kratki PVC beli	KLIK-KLAK kratki PVC črni
Cena	20,81	24,29	26,17	11,66	8,86	11,66	11,66

SIFONI ZA PISOAR



Koda	ESO0550	ESO0551	ESO0341	EMCR005	ETT3250	ETT4250	EPPP000
EAN	8595156223783	8595156223790	8595156223967	8595156242746	8595156242104	8595156242104	
Naziv	Sifon za pisoar, horizontalni priključek, DN50	Sifon za pisoar, vertikalni, priključek, DN50	Sifon za pisoar DN40	Sifonska cev za podaljšanje DN32 / 143mm	Podaljšek sifona G 5/4", DN32, 30 / 250mm	Podaljšek sifona G 6/4", DN40, 35 / 250mm	Podaljšek sifona gibljivi G1" / 98mm
Cena	21,91	21,91	6,94	7,95	3,42	3,42	4,84

SIFONI ZA TUŠ KAD



Koda	EWN0850	EWNN942	EWBN942	EWWN942	EWNN642
EAN	8595156222915	8595156242050	8595156262584	8595156210103	8595156241848
Naziv	Sifon za tuš kad 90/50 INOX	Sifon za tuš kad 90/40, INOX, nizki, koleno 45°- 40/50	Sifon za tuš kad 90/40 nizki, koleno 45°- 40/50, viš. 58mm, črn pokrov	Sifon za tuš kad 90/40 nizki, koleno 45°- 40/50, viš. 58mm, bel pokrov	Sifon za tuš kad 60/40 INOX nizki, koleno 45° 40/50
Cena	18,12	23,42	69,02	69,02	19,41

SIFONI ZA KOPALNO KAD



Koda	EVS0150	EVS0147	EVSB141	EVSB147
EAN	8595156241060			
Naziv	Sifon za kopalno kad automatic, DN40/50, L=610mm	Sifon METAL za kopalno kad automatic, sifon 40, koleno 40/50, L=780mm	Sifon PLASTIC za kopalno kad automatic, črn, sifon 40, koleno 40/50, L=610mm	Sifon PLASTIC za kopalno kad automatic, črn, sifon 40/50, L=780mm
Cena	47,04	49,50	78,52	81,36



Koda	EVSC147	EVN1M50	EVSE147
EAN		8595156226234	
Naziv	Sifon CHROME za kopalno kad automatic, sifon 40, koleno 40/50, L=780mm	Sifon za kopalno kad automatic, DN50, L=550mm s polnjenjem	Sifon PLASTIC za kopalno kad automatic, črn, sifon 40, koleno 40/50, L=780mm
Cena	38,13	163,13	35,85

ČEPI



Koda	YE40001	YE30001	YE31000	YE35000	EU04140	YE33000	YE34000
EAN	8595156221246	8595156221239	8595156223448	8595156223875	8595156212060	8595156223905	8595156223912
Naziv	Čep 6/4" (46 mm), verižica s čepom L 270mm	Čep 5/4" (39 mm), verižica s čepom L 270mm	Čep 46 mm, verižica s krogcem L440mm	Čep 46 mm, verižica s krogcem L 350mm	Čep 39mm	Čep 46mm	Čep 52mm
Cena	2,22	2,22	2,61	2,28	0,90	1,24	1,29

PROTISMRADNE KAPE

SIFONI KONDENZA

SIFONI ZA PRALNI STROJ



Koda	AVPO440	AVPT400	EK1P000	EPP1200	EPP1230
EAN	8595156241350	8595156229303	8595156229310	8595156240964	
Naziv	Protismradna kapa T-kos bela DN40	Protismradna kapa T-kos z navojem bela DN40	Sifon kondenza PVC beli DN32	Sifon za pralni stroj PVC enojni nadometni, matica, 10 - 16mm	Sifon za pralni stroj PVC enojni nadometni, matica, 18 - 23mm
Cena	10,46	10,46	7,38	1,64	1,65



Koda	EPVP000	EPVN000	EPPP450	EPPC450	EPP2300	EPP2330
EAN	8595156222700	8595156222700	8595156220515	8595156223431		
Naziv	Sifon za pralni stroj PVC enojni nadometni, DN32 beli	Sifon za pralni stroj PVC enojni nadometni, DN32 krom	Sifon za pralni stroj PVC enojni podometni, DN40/50 beli	Sifon za pralni stroj PVC enojni podometni, DN40/50 krom	Sifon za pralni stroj PVC dvojni nadometni, matica, 2 x 18 - 23mm	Sifon za pralni stroj PVC dvojni nadometni, matica, 10-16 / 18-23mm
Cena	3,37	6,32	4,39	6,38	10,46	10,46



Koda	EPPP452	EPT4200	EPT4300	EPT3200	EPT3300
EAN	8595156242739				8595156219366
Naziv	Sifon za pralni stroj PVC dvojni podometni, 2 x DN40/50	Sifon za pralni stroj PVC dvojni nadometni, ploski, matica, 2 x 18-23mm	Sifon za pralni stroj PVC dvojni nadometni, ploski, matica, 10-16 / 18-23mm	Sifon za pralni stroj PVC nadometni z odvodom kondenza, protipovratni ventil, DN32 18-23mm	Sifon za pralni stroj PVC z odvodom kondenza, protipovratni ventil, DN32, 10-16 / 18-23mm
Cena	12,38	10,46	10,46	10,46	10,46

TALNI SIFONI



Koda	SI50D00	SI50C00	SI50G01	SI5TC01	SI5TG01	SIFTALPRETPILREM	SIFONSUHIPIL
EAN	8595156230057	8595156202580	8595156241428	8595156225824	8595156241442	3830044752019	3830044752002
Naziv	Sifon talni suhi s protismradno zaporo za vgraditev keramike, DN50	Sifon talni suhi s protismradno zaporo, inox rešetka, DN50	Sifon talni suhi s protismradno gravitacijsko zaporo, inox rešetka, DN50	Sifon talni pretočni s protismradno zaporo, inox rešetka, DN50	Sifon talni pretočni s protismradno gravitacijsko zaporo, inox rešetka, DN50	Sifon talni pretočni Ø50, viš. 10cm	Sifon talni 1/1 suhi Ø50 PILREMAG, viš. 10cm
Cena	28,74	14,73	22,08	20,88	36,75	9,31	5,00

*Po naročilu

PVC ODTOČNA KANALETA KOMBI s kombiniranim sifonom (mokri/suhi) in INOX REŠETKO

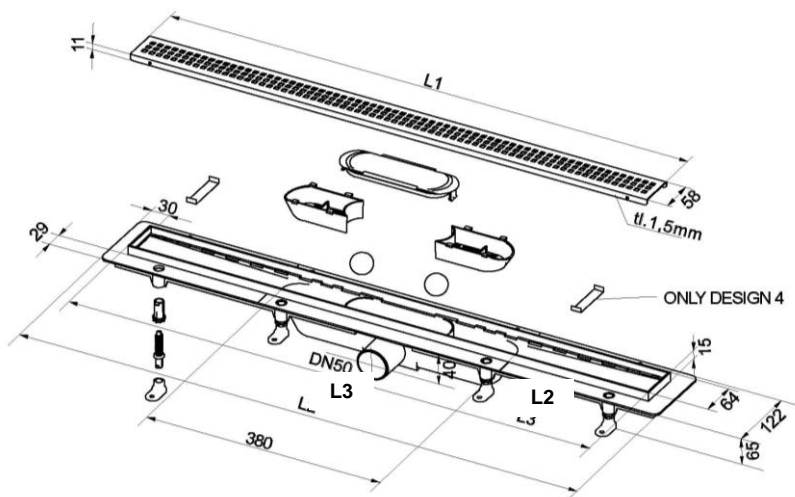

Design 1

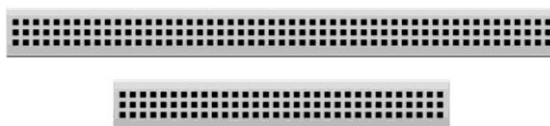

Koda	EAN	Naziv	Dolž. rešetke L1(mm)	Dolžina kanala L2(mm)	Dolžina prirobnice L3(mm)	DN	Cena
SZA1400 *	8595156218536	PVC kanaleta kombi INOX rešetka design 1 - 400mm	393	400	460	50	79,32
SZA1550	8595156218543	PVC kanaleta kombi INOX rešetka design 1 - 550mm	543	550	610	50	84,44
SZA1650	8595156218550	PVC kanaleta kombi INOX rešetka design 1 - 650mm	644	650	710	50	97,33
SZA1750	8595156218567	PVC kanaleta kombi INOX rešetka design 1 - 750mm	744	750	810	50	100,43
SZA1850	8595156218574	PVC kanaleta kombi INOX rešetka design 1 - 850mm	844	850	910	50	105,94

Design 2



Koda	EAN	Naziv	Dolž. rešetke L1(mm)	Dolžina kanala L2(mm)	Dolžina prirobnice L3(mm)	DN	Cena
SZA2400 *	8595156218581	PVC kanaleta kombi INOX rešetka design 2 - 400mm	393	400	460	50	79,32
SZA2550 *	8595156218598	PVC kanaleta kombi INOX rešetka design 2 - 550mm	543	550	610	50	84,44
SZA2650 *	8595156218604	PVC kanaleta kombi INOX rešetka design 2 - 650mm	644	650	710	50	97,33
SZA2750 *	8595156218611	PVC kanaleta kombi INOX rešetka design 2 - 750mm	744	750	810	50	100,43
SZA2850 *	8595156218628	PVC kanaleta kombi INOX rešetka design 2 - 850mm	844	850	910	50	105,94

Design 3

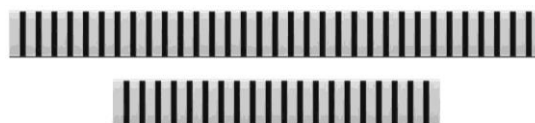

Koda	EAN	Naziv	Dolž. rešetke L1(mm)	Dolžina kanala L2(mm)	Dolžina prirobnice L3(mm)	DN	Cena
SZA3400 *	8595156218635	PVC kanaleta kombi INOX rešetka design 3 - 400mm	393	400	460	50	79,32
SZA3550 *	8595156218642	PVC kanaleta kombi INOX rešetka design 3 - 550mm	543	550	610	50	84,44
SZA3650	8595156218659	PVC kanaleta kombi INOX rešetka design 3 - 650mm	644	650	710	50	97,33
SZA3750	8595156218666	PVC kanaleta kombi INOX rešetka design 3 - 750mm	744	750	810	50	100,43
SZA3850	8595156218673	PVC kanaleta kombi INOX rešetka design 3 - 850mm	844	850	910	50	105,94

*Po naročilu

PVC ODTOČNA KANALETA KOMBI s kombiniranim sifonom (mokri/suhi) in INOX REŠETKO

Design 4 (2 v 1)



za keramiko debeline do 10mm



Koda	EAN	Naziv	Dolž. rešetke L1(mm)	Dolžina kanala L2(mm)	Dolžina prirobnice L3(mm)	DN	Cena
SZA4400 *	8595156218680	PVC kanaleta kombi INOX rešetka design 4(2v1) - 400mm	393	400	460	50	79,32
SZA4550 *	8595156218697	PVC kanaleta kombi INOX rešetka design 4(2v1) - 550mm	543	550	610	50	84,44
SZA4650	8595156218703	PVC kanaleta kombi INOX rešetka design 4(2v1) - 650mm	644	650	710	50	97,33
SZA4750	8595156218710	PVC kanaleta kombi INOX rešetka design 4(2v1) - 750mm	744	750	810	50	100,43
SZA4850	8595156218727	PVC kanaleta kombi INOX rešetka design 4(2v1) - 850mm	844	850	910	50	105,94

Design 5



Koda	EAN	Naziv	Dolž. rešetke L1(mm)	Dolžina kanala L2(mm)	Dolžina prirobnice L3(mm)	DN	Cena
SZA5400 *	8595156218734	PVC kanaleta kombi INOX rešetka design 5 - 400mm	393	400	460	50	79,32
SZA5550 *	8595156218741	PVC kanaleta kombi INOX rešetka design 5 - 550mm	543	550	610	50	84,44
SZA5650 *	8595156218758	PVC kanaleta kombi INOX rešetka design 5 - 650mm	644	650	710	50	97,33
SZA5750 *	8595156218765	PVC kanaleta kombi INOX rešetka design 5 - 750mm	744	750	810	50	100,43
SZA5850 *	8595156218772	PVC kanaleta kombi INOX rešetka design 5 - 850mm	844	850	910	50	105,94

Design 6



Koda	EAN	Naziv	Dolž. rešetke L1(mm)	Dolžina kanala L2(mm)	Dolžina prirobnice L3(mm)	DN	Cena
SZA6400 *	8595156220201	PVC odtočna kanaleta kombi, INOX rešetka 6 - 400mm	393	400	460	50	107,60
SZA6550 *	8595156220232	PVC odtočna kanaleta kombi, INOX rešetka 6 - 550mm	543	550	610	50	120,52
SZA6650 *	8595156220287	PVC odtočna kanaleta kombi, INOX rešetka 6 - 650mm	644	650	710	50	126,97
SZA6750 *	8595156220263	PVC odtočna kanaleta kombi, INOX rešetka 6 - 750mm	744	750	810	50	134,51
SZA6850 *	8595156220317	PVC odtočna kanaleta kombi, INOX rešetka 6 - 850mm	844	850	910	50	139,89

*Po naročilu

PVC ODTOČNA KANALETA z mokrim sifonom in INOX OKVIRJEM in REŠETKO

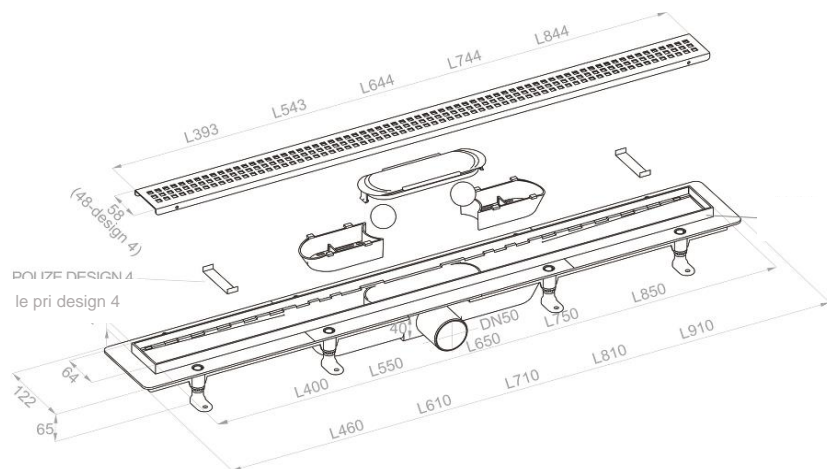

Design 1



Design 2



Design 3



Design 4 (2 v 1)

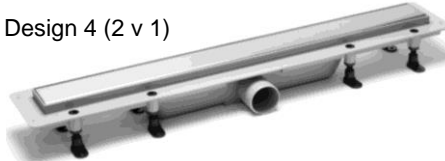

Design 5



Koda	EAN	Naziv	Dolž. rešetke L(mm)	Dolžina kanala L(mm)	Dolžina prirobnice L(mm)	DN	Cena
SZH1400		PVC odtočna kanaleta, INOX okvir in rešetka 1 - 400mm	393	400	460	50	142,04
SZH1550		PVC odtočna kanaleta, INOX okvir in rešetka 1 - 550mm	543	550	610	50	156,03
SZH1650		PVC odtočna kanaleta, INOX okvir in rešetka 1 - 650mm	644	650	710	50	164,63
SZH1750		PVC odtočna kanaleta, INOX okvir in rešetka 1 - 750mm	744	750	810	50	173,24
SZH1850		PVC odtočna kanaleta, INOX okvir in rešetka 1 - 850mm	844	850	910	50	181,85
SZH2400		PVC odtočna kanaleta, INOX okvir in rešetka 2 - 400mm	393	400	460	50	142,04
SZH2550		PVC odtočna kanaleta, INOX okvir in rešetka 2 - 550mm	543	550	610	50	156,03
SZH2650		PVC odtočna kanaleta, INOX okvir in rešetka 2 - 650mm	644	650	710	50	164,63
SZH2750		PVC odtočna kanaleta, INOX okvir in rešetka 2 - 750mm	744	750	810	50	173,24
SZH2850		PVC odtočna kanaleta, INOX okvir in rešetka 2 - 850mm	844	850	910	50	181,85
SZH3400		PVC odtočna kanaleta, INOX okvir in rešetka 3 - 400mm	393	400	460	50	142,04
SZH3550		PVC odtočna kanaleta, INOX okvir in rešetka 3 - 550mm	543	550	610	50	156,03
SZH3650		PVC odtočna kanaleta, INOX okvir in rešetka 3 - 650mm	644	650	710	50	164,63
SZH3750		PVC odtočna kanaleta, INOX okvir in rešetka 3 - 750mm	744	750	810	50	173,24
SZH3850		PVC odtočna kanaleta, INOX okvir in rešetka 3 - 850mm	844	850	910	50	181,85
SZH4400		PVC odtočna kanaleta, INOX okvir in rešetka 4 - 400mm	393	400	460	50	142,04
SZH4550		PVC odtočna kanaleta, INOX okvir in rešetka 4 - 550mm	543	550	610	50	156,03
SZH4650		PVC odtočna kanaleta, INOX okvir in rešetka 4 - 650mm	644	650	710	50	164,63
SZH4750		PVC odtočna kanaleta, INOX okvir in rešetka 4 - 750mm	744	750	810	50	173,24
SZH4850		PVC odtočna kanaleta, INOX okvir in rešetka 4 - 850mm	844	850	910	50	181,85
SZH5400		PVC odtočna kanaleta, INOX okvir in rešetka 5 - 400mm	393	400	460	50	142,04
SZH5550		PVC odtočna kanaleta, INOX okvir in rešetka 5 - 550mm	543	550	610	50	156,03
SZH5650		PVC odtočna kanaleta, INOX okvir in rešetka 5 - 650mm	644	650	710	50	164,63
SZH5750		PVC odtočna kanaleta, INOX okvir in rešetka 5 - 750mm	744	750	810	50	173,24
SZH5850		PVC odtočna kanaleta, INOX okvir in rešetka 5 - 850mm	844	850	910	50	181,85

*Po naročilu

INOX ODTOČNA KANALETA z mokrim sifonom in INOX OKVIRJEM in REŠETKO

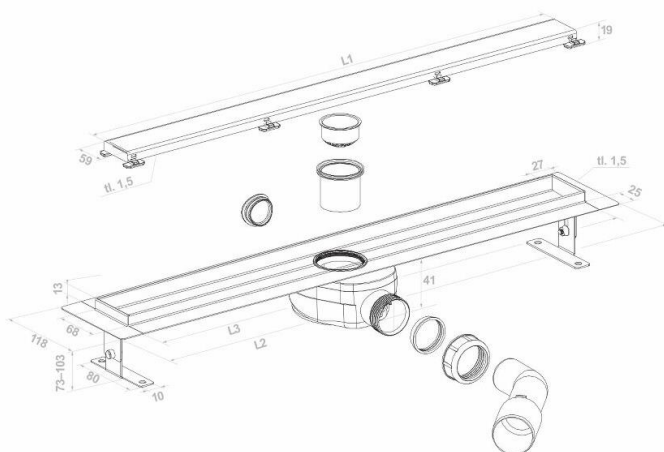

Design 2



Koda	EAN	Naziv	Dolž. rešetke L1 (mm)	Dolžina prirobnice L2 (mm)	Dolžina kanala L3 (mm)	DN	Cena
SZU2650		INOX odtočna kanaleta / rešetka design 2 - 650mm	650	708	651	40/50	230,58
SZU2750		INOX odtočna kanaleta / rešetka design 2 - 750mm	750	808	751	40/50	248,51
SZU2850		INOX odtočna kanaleta / rešetka design 2 - 850mm	850	908	851	40/50	266,45
SZU2950		INOX odtočna kanaleta / rešetka design 2 - 950mm	950	1008	951	40/50	281,82

Design 4



Koda	EAN	Naziv	Dolž. rešetke L1 (mm)	Dolžina prirobnice L2 (mm)	Dolžina kanala L3 (mm)	DN	Cena
SZU4650		INOX odtočna kanaleta / rešetka design 4 - 650mm	650	708	651	40/50	235,70
SZU4750		INOX odtočna kanaleta / rešetka design 4 - 750mm	750	808	751	40/50	251,08
SZU4850		INOX odtočna kanaleta / rešetka design 4 - 850mm	850	908	851	40/50	271,57
SZU4950		INOX odtočna kanaleta / rešetka design 4 - 950mm	950	1008	951	40/50	286,94

Design 5



Koda	EAN	Naziv	Dolž. rešetke L1 (mm)	Dolžina prirobnice L2 (mm)	Dolžina kanala L3 (mm)	DN	Cena
SZU5650		INOX odtočna kanaleta / rešetka design 5 - 650mm	650	708	651	40/50	230,58
SZU5750		INOX odtočna kanaleta / rešetka design 5 - 750mm	750	808	751	40/50	248,51
SZU5850		INOX odtočna kanaleta / rešetka design 5 - 850mm	850	908	851	40/50	266,45
SZU5950		INOX odtočna kanaleta / rešetka design 5 - 950mm	950	1008	951	40/50	281,82

*Po naročilu

INOX ODTOČNA KANALETA OB STENI z mokrim sifonom in INOX OKVIRJEM in REŠETKO

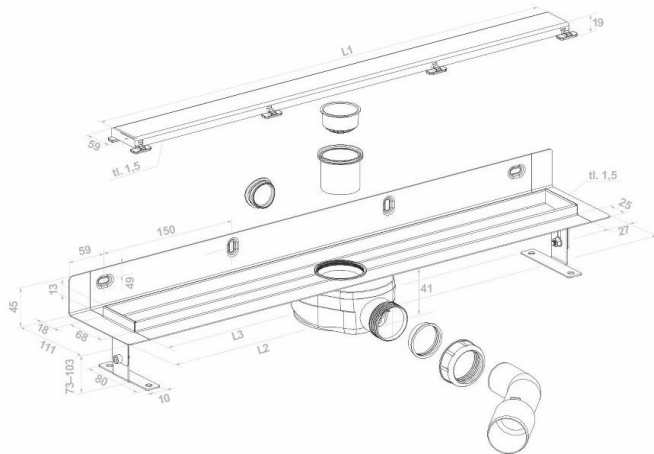

Design 2



Koda	EAN	Naziv	Dolž. rešetke L1 (mm)	Dolžina prirobnice L2 (mm)	Dolžina kanala L3 (mm)	DN	Cena
SZZ2650		INOX odtočna kanaleta ob steni, INOX rešetka 2 - 650mm	650	708	651	40/50	240,83
SZZ2750		INOX odtočna kanaleta ob steni, INOX rešetka 2 - 750mm	750	808	751	40/50	256,20
SZZ2850		INOX odtočna kanaleta ob steni, INOX rešetka 2 - 850mm	850	908	851	40/50	274,13
SZZ2950		INOX odtočna kanaleta ob steni, INOX rešetka 2 - 950mm	950	1008	951	40/50	289,51

Design 4



Koda	EAN	Naziv	Dolž. rešetke L1 (mm)	Dolžina prirobnice L2 (mm)	Dolžina kanala L3 (mm)	DN	Cena
SZZ4650		INOX odtočna kanaleta ob steni, INOX rešetka 4 - 650mm	650	708	651	40/50	243,39
SZZ4750		INOX odtočna kanaleta ob steni, INOX rešetka 4 - 750mm	750	808	751	40/50	261,32
SZZ4850		INOX odtočna kanaleta ob steni, INOX rešetka 4 - 850mm	850	908	851	40/50	279,26
SZZ4950		INOX odtočna kanaleta ob steni, INOX rešetka 4 - 950mm	950	1008	951	40/50	294,63

Design 5



Koda	EAN	Naziv	Dolž. rešetke L1 (mm)	Dolžina prirobnice L2 (mm)	Dolžina kanala L3 (mm)	DN	Cena
SZZ5650		INOX odtočna kanaleta ob steni, INOX rešetka 5 - 650mm	650	708	651	40/50	240,83
SZZ5750		INOX odtočna kanaleta ob steni, INOX rešetka 5 - 750mm	750	808	751	40/50	256,20
SZZ5850		INOX odtočna kanaleta ob steni, INOX rešetka 5 - 850mm	850	908	851	40/50	274,13
SZZ5950		INOX odtočna kanaleta ob steni, INOX rešetka 5 - 950mm	950	1008	951	40/50	289,51

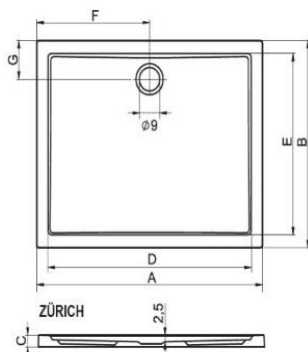

TUŠ KAD ZÜRICH 250

Koda	EAN	Cena
D001007005	8714148328774	206,80

Tuš kad Zurich 250
 Material: akril
 Dimenzije: 90cm x 90cm
 Globina: 2,5cm
 Višina: 4,5cm

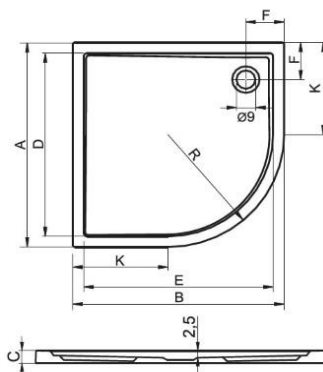

TUŠ KAD ZÜRICH 280

Koda	EAN	Cena
D001022005	8714148368824	203,02

Tuš kad Zurich 280
 Material: akril
 Dimenzije: 90cm x 90cm
 Polkrožna z radijem 55cm
 Globina 2,5cm
 Višina 4,5cm

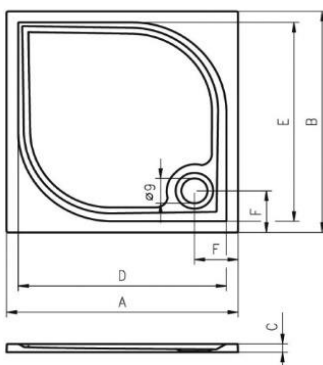

TUŠ KAD KOLPING DB 21

Koda	EAN	Cena
D004005005	8714148342527	372,99

Tuš kad Kolping DB 21
 Material: liti marmor
 Dimenzije: 90cm x 90cm
 Globina: 1cm
 Višina: 3cm

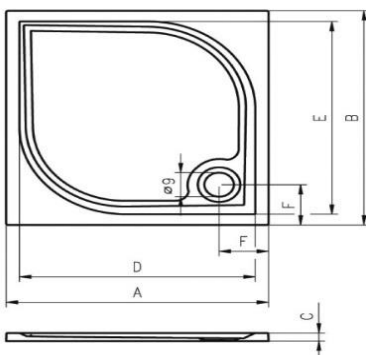

TUŠ KAD KOLPING DB 31

Koda	EAN	Cena
D004006005	8714148342541	349,38

Tuš kad Kolping DB 31
 Material: liti marmor
 Dimenzije: 80cm x 100cm
 Globina: 1cm
 Višina: 3cm

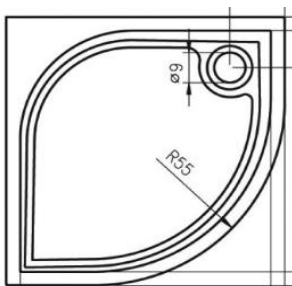

TUŠ KAD KOLPING DB 14

Koda	EAN	Cena
D004002005	8714148342473	335,22

Tuš kad Kolping DB 14
 Material: liti marmor
 Dimenzije: 90cm x 90cm
 Polkrožna z radijem 55cm
 Globina 1cm
 Višina 3cm

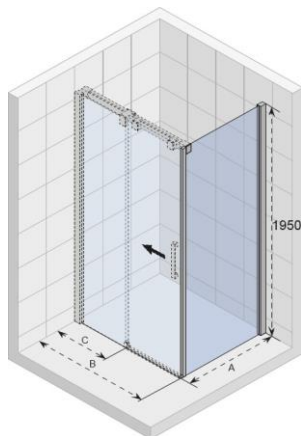

TUŠ KABINA OCEAN kvadratna

Koda Cena

G006004120 leva **714,82**

EAN: 14148595480

G006005120 desna **714,82**

EAN: 14148595510

Tuš kabina Ocean 100 x 80cm

Širina vhodne stene: 965 - 990mm

Širina fiksne stene: 765 - 780mm

Višina: 1950mm

Vhod: 400mm

Zaščitni premaz proti vodnemu kamnu

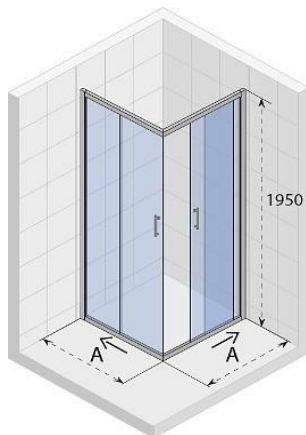

TUŠ KABINA HAMAR kvadratna

Koda Cena

G007005120 **458,92**

EAN: 14148592823

Tuš kabina Hamar 90 x 90cm

Širina: 870 - 905mm

Globina: 870 - 905 mm

Višina: 1950mm

Vhod: 500mm

Zaščitni premaz proti vodnemu kamnu

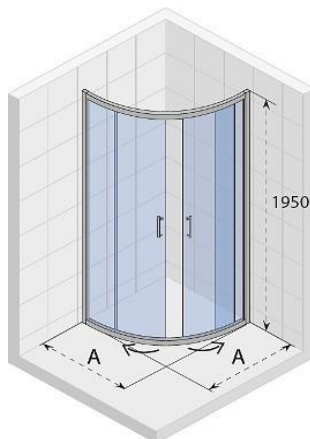

TUŠ KABINA HAMAR polkrožna

Koda Cena

G007002120 **488,20**

EAN: 14148592786

Tuš kabina Hamar 90 x 90cm, satinirana

Širina: 870 - 905mm

Globina: 870 - 905mm

Višina: 1950mm

Vhod: 520mm

Zaščitni premaz proti vodnemu kamnu

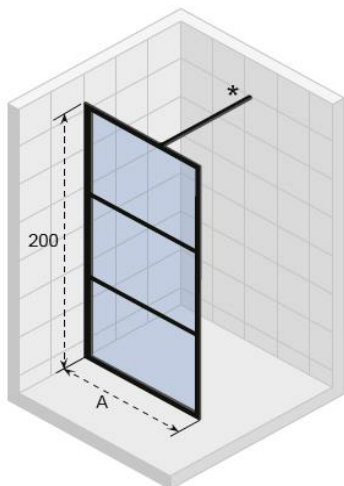

TUŠ STENA GRID

Koda Cena

G004027121 **618,50**

EAN: 14148577202

Tuš stena Grid 120cm

Širina: 1188 - 1198mm

Debelina stekla: 6mm

Višina: 2000mm

Oporni nosilec: dolžina 900mm

Okvir črn satiniran

Zaščitni premaz proti vodnemu kamnu

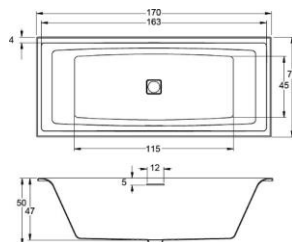

STILL SQUARE (LED)

Koda Cena
B100004005 **885,73**

EAN: 8714148571736

Vgradna kopalna kad
 Still Square Led 170 x 75cm, 265 litrov.
 LED osvetlitev.
 Vgradna višina 47cm (50) cm.

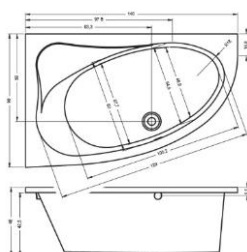

LYRA

Koda Cena
B019001005 **426,82**

EAN: 8714148313299

Kotna kopalna kad
 Lyra 140 x 90 cm, 200 litrov.
 Vgradna višina 42,5cm (46) cm.

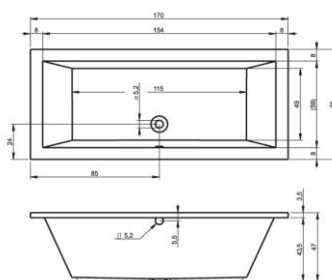

LUSO

Koda Cena
B036001005 **597,73**

EAN: 8714148425039

Vgradna kopalna kad
 Lusso 180 x 80 cm, 295 litrov.
 Vgradna višina 44cm (47,5) cm

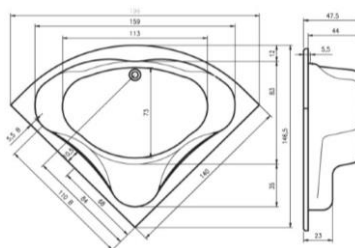

NEO

Koda Cena
B076001005 **509,91**

EAN: 8714148062630

Kotna kopalna kad
 Neo 140 x 140cm, 315 litrov.
 Vgradna višina 44cm (47,5) cm.

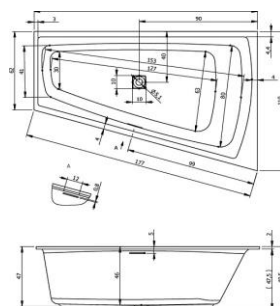

STILL SMART (LED)

Koda Cena
B101003005 **1.046,26**

EAN: 8714148572702

Kotna kopalna kad
 Still Smart Led 170 x 110 x 45cm, 320litrov
 Vgradna višina 47,5cm (49) cm.

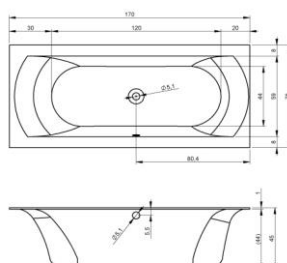

LINARES

Koda Cena
B141001005 **377,71**

EAN: 8714148547984

Vgradna kopalna kad
 Linares 170 x 75 cm, 210 litrov.
 Vgradna višina 44cm (45) cm.
 Debelina roba kadi samo 1cm!

SERIJA NIKA



Koda	NIKA60	NIKA-N1	<small>Po naročilu</small> NIKA-N2	NIKA-FI38
EAN	8606008911113			
Naziv	Umivalnik Nika nadpultni brez luknje za pipo, š 60cm, g 36cm	Umivalnik Nika nadpultni š 50cm, g 36cm	Umivalnik Nika nadpultni š 60cm, g 36cm	Umivalnik Nika nadpultni okrogli premer 38cm
Cena	142,04	134,94	151,51	123,58



Koda	500100	500200	SIN380	SL550
EAN	8600198360188	8600198361789	8606008911052	8606008911038
Naziv	Wc školjka Nika konzolna z desko soft close g 55,5cm, š 37cm, v 35,4cm	Bide Nika konzolni g 55cm, š 38cm, v 33cm	Umivalnik Nika 380 š 38cm, g 32cm	Umivalnik Nika 550 š 55cm, g 46cm
Cena	262,69	214,42	35,10	65,29

SERIJA VIKTORIJA - UMIVALNIKI



Koda	SV07SR	SV01SR	SV06SR
EAN	8606008910024	8606008910017	8606008910031
Naziv	Umivalnik Viktorija 500 š 52cm, g 42cm	Umivalnik Viktorija 600 š 60cm, g 48cm	Umivalnik Viktorija 460 š 46cm, g 37cm
Cena	47,67	57,28	43,40



Koda	SL550PULT	SL650PULT
EAN	8606008911038	
Naziv	Umivalnik polvgradni š 55cm, g 46cm	Umivalnik polvgradni š 65cm, g 51cm
Cena	57,00	67,69

SERIJA VIKTORIJA - WC ŠKOLJKE IN BIDEJI



Koda	SVB03	SVS03	SV05
EAN	8606008910079	8606008910062	8606008910109
Naziv	Wc Viktorija baltik, stojeci, brez deske, stenski odtok	Wc Viktorija simplon, stojeci, brez deske, talni odtok	Bide Viktorija, stojeci
Cena	59,78	59,78	79,68



Koda	SVS03KON	SV05KON	MONOVIKT <small>odprodaja</small>
EAN	8606008910932	8606008911090	8606008910086
Naziv	Wc Viktorija viseci, brez deske	Bide Viktorija, viseci	Wc Viktorija monoblok z desko soft close komplet
Cena	76,01	90,61	116,80



Koda	SVD03	OSSE000	LIV1409268201
EAN	8606008910871	859515623030	8711778221307
Naziv	Wc Viktorija otroški, z desko, talni odtok simplon	Wc deska Sandra Soft close easy fix	Wc deska Virgo S
Cena	103,99	36,45	40,26

SERIJA VIKTORIJA ZA STAROSTNIKE IN INVALIDE



Koda	SVS60IK	SVS03IK	SVS03KONIK
EAN		8606008910918	8606008911076
Naziv	Ergonomski umivalnik za starostnike in invalide š 61cm, g 50cm	Wc školjka Viktorija invalidska stojeca z desko, talni odtok	Wc školjka Viktorija invalidska viseca z desko
Cena	134,12	200,61	227,74

PISOARJI



Koda	ZPN02	ZPN02BR	ZPN03-IZP	odprodaja	ZPN03
EAN	8606008910833	8606008910833			8606008910956
Naziv	Pisoar Poseidon s skritim sifonom, dotok zgoraj	Pisoar Poseidon s skritim sifonom, komplet vijakov, dotok zadaj	Klasični pisoar Eco z izpiranjem		Pisoar Eco brez izpiranja, s sifonom
Cena	91,56	91,56	36,60		446,43

WC ČEPEČI (POLJSKI)

TROKADERO



Koda	SV111	SVT01KONZOLNI	SVT01K	SVT01KBAL
EAN	8606008910505			8606008910895
Naziv	Wc čepeči (poljski)	Trokadero s PVC rešetko, viseči	Trokadero simplon s PVC rešetko, talni odtok	Trokadero baltik s PVC rešetko, stenski odtok
Cena	93,64	321,25	321,25	321,25

SIFON

PREGRADA ZA PISOAR

PVC UMIVALNIK (GARAŽNI)



Koda	M25E	ZPNPREGRADA	VU50440	VU60440
EAN			8595156242074	8595156242081
Naziv	Rezervni sifon za Eco pisoar	Pregrada za pisoar ECO, POSEIDON	PVC umivalnik komplet, širina 50 cm	PVC umivalnik komplet, širina 60 cm
Cena	195,14	82,28	44,29	45,63

GREEN - SERIJA na zalogi



Koda	GR071CR	GR075CR	GR135CR	GR168CR	GR022CR
EAN	8020913497775	8020913493548	8020913497881	8020913497904	8020913497713
Naziv	Armatura za umivalnik	Armatura za umivalnik s sifonom	Armatura za bide	Armatura za tuš brez izliva	Armatura za kopalno kad
Cena	92,33	98,77	102,38	113,31	139,86

BLUE - SERIJA na zalogi



Koda	BLU071CR	BLU075CR	BLU135CR	BLU168CR	BLU022CR
EAN	8020913071630	8020913071746	8020913071753	8020913071975	8020913071661
Naziv	Armatura za umivalnik	Armatura za umivalnik s sifonom	Armatura za bide	Armatura za tuš brez izliva	Armatura za kopalno kad
Cena	63,44	74,27	77,69	86,08	117,41

ELLE - SERIJA



Koda	EL071CR	EL075CR	EL135CR	EL168CR	EL022CR
EAN	8020913108787	8020913110216	8020913110377	8020913110438	8020913108718
Naziv	Armatura za umivalnik	Armatura za umivalnik s sifonom	Armatura za bide	Armatura za tuš brez izliva	Armatura za kopalno kad
Cena	143,08	167,09	167,09	181,15	248,78

WEST - SERIJA na zalogi



Koda	WS071CR	WS075CR	WS135CR	WS168CR	WS022CR
EAN	8020913087112	8020913086672	8020913087167	8020913097708	8020913086689
Naziv	Armatura za umivalnik	Armatura za umivalnik s sifonom	Armatura za bide	Armatura za tuš brez izliva	Armatura za kopalno kad
Cena	116,92	132,44	132,44	146,99	232,78

LIGHT - SERIJA dobavljiva v devetih različnih barvah



Koda	LIG071CR	LIG075CR	LIG131CR	LIG168CR	LIG022CR
EAN	8020913060863	8020913057832	8020913069132	8020913070749	8020913063710
Naziv	Armatura za umivalnik	Armatura za umivalnik s sifonom	Armatura za bide	Armatura za tuš brez izliva	Armatura za kopalno kad
Cena	132,44	163,28	135,18	214,04	267,03

LIGHT - SERIJA matt black



Koda	LIG071NO	LIG075NO	LIG131NO	LIG104NO	ZSCA050NO
EAN	8020913530878	8020913540150	8020913536009	8020913581399	8020913459568
Naziv	Armatura za umivalnik	Armatura za umivalnik s sifonom	Armatura za bide	Armatura za umivalnik	Klik-klak sifon 1 1/4" SIMPLE RAPID
Cena	172,26	212,18	175,68	301,10	42,46



Koda	LIG081NO	LIG285NO-MET	LIG280NO	LIG179NONO	ZDUP110NO	ZSUP031NO
EAN	8020913530885	8020913536931	8020913536870	8020913536955	8020913554089	8020913487554
Naziv	Armatura za umivalnik	Armatura za umivalnik	Armatura za umivalnik	Armatura za kuhinjo	WC tuš ročka TWEET ROUND MIX	WC ventil za tuš ročka TONDO
Cena	292,60	283,82	232,48	439,49	148,94	55,14



Koda	LIG168NO	LIQ168ENO	LIG022NO
EAN	8020913536016	8020913528127	8020913535897
Naziv	Armatura za tuš brez izliva	Armatura za tuš brez izliva termostatska ECOSTOP	Armatura za tuš / kopalno kad
Cena	278,36	243,51	347,36

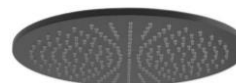

Koda	LIG015NO	LIG018NO	ZSOF034NO	ZSOF079NO	ZSOF074NO
EAN	8020913530441	8020913530458	8020913487578	8020913545223	8020913486519
Naziv	Armatura za tuš podometna	Armatura za tuš podometna	Stenski nosilec d=40cm, okrogli	Stropna pršna glava okrogla D=30cm MASTER KING	Stropna pršna glava okrogla D=22,5cm MASTER
Cena	213,35	337,89	71,74	287,92	136,54



Koda	ZCOL638LIQNO	ZSAL146NO	ZDOC067NO	ZDOC125NO	ZFLO071NO
EAN	8020913582730	8020913585229	8020913536030	8020913585175	8020913534357
Naziv	Tuš konzola z ročico in cevjo MINI BIRILLO, glava MASTER	Tuš konzola z ročico LIFE GINEVRA viš.755mm	Pršna ročica MASTER	Pršna ročica GINEVRA	Pršna cev Twist-free 150cm
Cena	785,39	175,48	41,28	45,19	21,96

STENSKI PRŠNI SETI



Koda	ZSAL112CR	ZSAL121CR	ZCOL643CR	KITLIG015CR
EAN	8020913064656	8020913064694		8020913498024
Naziv	Tuš konzola TRIESTE z ročico, milnikom in cevjo	Tuš konzola QUEEN z ročico, milnikom in cevjo	Pršni tuš set termostatski	Podometni komplet za tuš kabino
Cena	41,48	48,21	328,94	373,22

STROPNE PRŠNE GLAVE



Koda	ZSOF074CR	ZSOF034CR	ZSOF075CR	ZSOF063CR
EAN	8020913063628	8020913065172	8020913063659	8020913065189
Naziv	Stropna pršna glava okrogla D=225mm	Stenski nosilec d=40cm, okrogli	Stropna pršna glava 200 x 200mm	Stenski nosilec d=40cm, kvadratni
Cena	102,87	55,53	114,09	83,16

TUŠ ROČICE

TUŠ CEVI

HANDY SW tuš ročica



Koda	ZDOC081CR	ZFLO001CR	ZSUP010CR	8206812	
EAN	8020913092260	8020913045297	8020913057122	7394326808000	
Naziv	Pršna ročica TRIESTE	Pršna cev Twist-free 150cm	Zidni nosilec tuš ročice	Tuš ročica HANDY SW kromirana	Preprosta montaža na armaturo v kopalnici, kuhinji, navoj DN15, pritrdilni ventil, 1,5m fleksibilne cevi, tuš ročica s tipko za izmenično uporabo tuš - pipa.
Cena	6,34	9,96	2,83	35,38	

KUHINJSKE ARMATURE na zalogi



Koda	WS285CR	NT183CR	NT182CR	GR180CR
EAN	8020913087297	8020913033805	8020913033799	8020913497911
Naziv	Kuhinjska armatura WEST izvlečna	Kuhinjska armatura NETTUNO izvlečna	Kuhinjska armatura NETTUNO izvlečna s tremi cevčkami za tlačni bojler	Kuhinjska armatura OMBRELLO
Cena	179,10	141,52	113,61	107,56

OGLEDALA



Koda	ZP 16000R	ZP 16000RV	ZP 26002RV	ZP 8003
EAN	8595187110946	8595187112940		8595187110878
Naziv	Okroglo ogledalo z integrirano LED lučjo 60cm	Okroglo ogledalo z integrirano LED lučjo 60cm, senzor na dotik	Okroglo ogledalo z integrirano LED lučjo 80cm, senzor na dotik	Kvadratno ogledalo z integrirano LED lučjo 80 x 60cm
Cena	209,60	247,42	419,68	209,60



Koda	ZP 18002V	ZP 11002V	ZP 12003V	ZP 13003V	ZP 14002V
EAN	8595187113008	8595187112803	8595187112827	8595187112889	8595187112926
Naziv	Kvadratno ogledalo z integrirano LED lučjo 60 x 80cm, senzor na dotik	Kvadratno ogledalo z integrirano LED lučjo 60 x 80cm, senzor na dotik	Kvadratno ogledalo z integrirano LED lučjo 80 x 70cm, senzor na dotik	Kvadratno ogledalo z integrirano LED lučjo 80 x 70cm, senzor na dotik	Kvadratno ogledalo z integrirano LED lučjo 60 x 80cm, senzor na dotik
Cena	323,06	310,49	314,64	323,06	352,46

KIBO - na zalogi



Koda	Ki 14058K-26	Ki 14031K-26	Ki 14059K-26	Ki 14055E-26	Ki 14055g-26	Ki 14055-26
EAN	8595187105904	8595187105881	8595187105898	8595187106109	8595187106093	8595187106086
Naziv	Kozarec za ščetke, keramika	Milnik za tekoče milo, keramika	Skodelica za milo, keramika	Držalo wc papirja E	Držalo wc papirja G	Držalo wc papirja
Cena	37,82	41,97	37,82	33,18	33,18	37,82











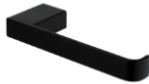

Koda	Ki 14094KN-26	Ki 14094K-26	Ki 14096-26	Ki 14061-26	Ki 14046-26	Ki 14053-26
EAN	8595187109643	8595187106116	8595187106079	8595187106031	8595187106024	8595187105980
Naziv	Wc ščetka keramična viseča mala	Wc ščetka keramična viseča velika	Nosilec brisač dvojni pregibni, 38cm	Nosilec brisač 63cm	Nosilec brisač 48cm	Obešalnik dvojni
Cena	48,68	74,30	62,95	67,22	54,53	20,98



Koda	Ki 14003-26	Ki 14015-26	Ki 14003H-26	Ki 14015H-26	Ki 14017D-26	Ki 14001H-26
EAN	8595187105812	8595187105829	8595187105850	8595187105867	8595187105836	8595187105874
Naziv	Košarica za v tuš kotna 85 x 67 x 230mm	Košarica za v tuš 178 x 105 x 85mm	Košarica za v tuš kotna z obešalom 390 x 167 x 230mm	Košarica za v tuš viseča enojna 390 x 105 x 178mm	Košarica za v tuš dvojna 337 x 140 x 228mm	Obešalo za košarico v tušu
Cena	54,53	50,39	67,22	62,95	121,76	18,42









KIBO black matt

					
Koda Ki 14031K-T-90	Ki 14058K-90	Ki 14059K-90	Ki 14055g-90	Ki 14094K-90	Ki 14094KN-90
EAN 8595187112216	8595187112261	8595187112278	8595187112254	8595187112360	8595187112377
Naziv Milnik za tekoče milo, keramika	Kozarec za ščetke, keramika	Skodelica za milo, keramika	Držalo wc papirja	Wc ščetka viseča, keramika	Wc ščetka viseča nizka, keramika
Cena 62,95	46,24	46,24	40,75	96,62	58,80
					
Koda Ki 14053-90	Ki 14060g-90	Ki 14046-90	Ki-14091B-30-90	Ki-14091B-40-90	Ki 14091B-50-90
EAN 8595187112247	8595187112285	8595187112223	8595187112308	8595187110137	8595187112322
Naziv Obešalnik dvojni	Nosilec brisač 25cm	Nosilec brisač 48cm	Polica, 30cm x 12,3cm, satinirano belo steklo	Polica, 40cm x 12,3cm, satinirano belo steklo	Polica, 50cm x 12,3cm, satinirano belo steklo
Cena 24,28	46,24	67,22	48,31	50,39	44,53













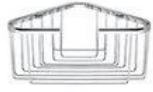

NIKAU black matt

					
Koda NKC 30031K-T-90	NKC 30031C-T-90	NKC 30031H-T-90	NKC 30058K-90	NKC 30058C-90	NKC 30058H-90
EAN 8595187114920	8595187114913		8595187115002	8595187114999	
Naziv Milnik za tekoče milo, kratki, keramika	Milnik za tekoče milo, kratki, steklo	Milnik za tekoče milo, dolgi, keramika	Kozarec za ščetke, kratki, keramika	Kozarec za ščetke, kratki, steklo	Kozarec za ščetke, dolgi, keramika
Cena 79,67	84,67	84,67	59,41	63,93	63,93
					
Koda NKC 30059K-90	NKC 30059C-90	NKC 30055-90	NKC 30055R-90	NKC 30094KN-90	NKC 30094CN-90
EAN 8595187115026	8595187115019	8595187114975	8595187114982	8595187115125	8595187115118
Naziv Skodelica za milo, keramika	Skodelica za milo, steklo	Držalo wc papirja	Držalo wc papirja vertikalno	Wc ščetka viseča, keramika	Wc ščetka viseča, steklo
Cena 59,41	63,93	50,39	50,39	75,15	85,16
					
Koda NKC 30054-90	NKC 30097-90	NKC 30098-90	NKC 30035-90	NKC 30046-90	NKC 30061-90
EAN 8595187114968	8595187115149	8595187115156	8595187114937	8595187114944	8595187115040
Naziv Obešalnik enojni kljukica	Držalo brisač 39cm	Držalo brisač dvojno, 39cm	Nosilec brisač 39cm	Nosilec brisač 49cm	Nosilec brisač 63cm
Cena 24,16	68,93	100,77	75,15	85,16	100,77
					
Koda NKC X320-C-90	NKC X330-C-90	NKC X340-C-90	NKC X350-C-90	NKC 30091B-50-90	NKC 30091B-60-90
EAN 8595187115255	8595187115262	8595187115279	8595187115286	8595187115088	8595187115095
Naziv Polica, 20cm x 12,5cm črno mat steklo	Polica, 30cm x 12,5cm črno mat steklo	Polica, 40cm x 12,5cm črno mat steklo	Polica, 50cm x 12,5cm črno mat steklo	Polica, 50cm x 11,5cm satinirano belo steklo	Polica, 60cm x 11,5cm satinirano belo steklo
Cena 55,51	60,51	65,39	70,52	60,51	63,56

UNIX - na zalogi

					
Koda UN 13031W-T-26	Koda UN 13059W-26	Koda UN 13054-26	Koda UN 13053-26	Koda UN 13054N-26	Koda UN 13060-26
EAN 8595187112568	EAN 8595187109636	EAN 8595187104785	EAN 8595187104792	EAN 8595187104778	EAN 8595187104808
Naziv Držalo za trdo milo mat steklo	Naziv Držalo za trdo milo satin steklo	Naziv Obešalnik krom	Naziv Obešalnik dvojni krom	Naziv Obešalnik kljukica, krom	Naziv Držalo za brisače okroglo, krom
Cena 44,90	Cena 27,69	Cena 12,57	Cena 13,79	Cena 10,49	Cena 22,69
					
Koda UN 13055B-26	Koda UN 13055M-26	Koda UN 13058W-26	Koda UN 13058DW-26	Koda UN 13031W-26	Koda UN 13031MN-26
EAN 8595187104952	EAN 8595187104969	EAN 8595187106376	EAN 8595187106383	EAN 8595187106369	EAN 8595187106130
Naziv Držalo za toaletni papir s pokrovom, krom	Naziv Držalo za toaletni papir palica, krom	Naziv Kozarec za ščetke satin steklo	Naziv Kozarec 2x za ščetke satin steklo	Naziv Držalo za tekoče milo satin steklo	Naziv Milnik za tekoče milo, krom, odprodaja
Cena 29,40	Cena 26,84	Cena 27,69	Cena 41,97	Cena 36,51	Cena 44,90
					
Koda UN 13035-26	Koda UN 13046-26	Koda UN 13061D-26	Koda UN 13096-26	Koda UN 13096N-26	Koda UN 13054-5-26
EAN 8595187104853	EAN 8595187104860	EAN 8595187104877	EAN 8595187104914	EAN 8595187109605	EAN 8595187104839
Naziv Držalo za brisače 35cm, krom	Naziv Držalo za brisače 50cm, krom	Naziv Držalo brisač dvojno 66cm	Naziv Držalo brisač dvojno konzola 41cm	Naziv Držalo brisač dvojno konzola 41cm	Naziv Držalo za brisače 5 kljukic, krom
Cena 24,77	Cena 29,40	Cena 40,26	Cena 39,89	Cena 37,82	Cena 33,55
					
Koda UN 13011-26	Koda UN 13012-26	Koda UN 13091B-40-26	Koda UN 13094WN-26	Koda UN 13094E-26	Koda UN 13095K-26
EAN 8595187109582	EAN 8595187109599	EAN 8595187110182	EAN 8595187110274	EAN 8595187105034	EAN 8595187105218
Naziv Držalo sušilca za lase	Naziv Čistilec stekla v tušu	Naziv Polica, 40cm, belo steklo	Naziv Wc ščetka viseča, mat steklo	Naziv Wc ščetka viseča / talna, inox	Naziv Prostostoječi set z wc ščetko in držalom za toaletni papir
Cena 29,40	Cena 33,18	Cena 33,55	Cena 36,97	Cena 52,09	Cena 134,44

MONOLIT - projektna serija

					
Koda MO 4031C-P-26	Koda MO 4059C-26	Koda MO 4058C-26	Koda MO 4055-26	Koda MO 4055B-26	Koda MO 4054-26
EAN 8595187105386	EAN 8595187104006	EAN 8595187103993	EAN 8595187103979	EAN 8595187103962	EAN 8595187103986
Naziv Milnik za tekoče milo mat steklo	Naziv Milnik za trdo milo mat steklo	Naziv Kozarec za ščetke mat steklo	Naziv Držalo za wc papir	Naziv Držalo za wc papir s pokrovom	Naziv Obešalnik-kljukica
Cena 14,27	Cena 12,57	Cena 12,57	Cena 13,42	Cena 14,64	Cena 5,86
					
Koda MO 4094C-26	Koda OP 106-26	Koda OP 111N-26	Koda OP 101N-26	Koda OP 112N-26	Koda MO 4096-26
EAN 8595187104037	EAN 8595187104488	EAN 8595187106826	EAN 8595187105089	EAN 8595187109247	EAN 8595187104075
Naziv Wc ščetka viseča mat steklo	Naziv Milnik za trdo milo kotni 17,5 x 17,5 x 10cm	Naziv Milnik za trdo milo ravni 13,5 x 9,3 x 3,3cm	Naziv Milnik za trdo milo kotni 13,5 x 13,5 x 3,3cm	Naziv Milnik za trdo milo ravni 10 x 11 x 20cm	Naziv Držalo brisač dvojno 49cm
Cena 25,13	Cena 30,62	Cena 19,28	Cena 20,98	Cena 31,84	Cena 19,28
					
Koda MO 4046-26	Koda BM 7235-18	Koda MO 4061D-26	Koda MO 4091X-26		
EAN 8595187104044	EAN 8595187102583	EAN 8595187104051			
Naziv Nosilec brisač 50cm	Naziv Ročaj 40cm x 25cm	Naziv Nosilec brisač 68cm - dvojni	Naziv Polica z ograjico 40cm, steklo		
Cena 19,76	Cena 24,28	Cena 29,40	Cena 25,13		

* Po naročilu

KOPALNIŠKI DODATKI ZA STAROSTNIKE IN INVALIDE



Koda	EH-NWA-60-PCX	EH-NWA-70-PCX	EH-NWA-80-PCX	EHP-FA-70-PC	EH-N12-PCX	EH-N18-PCX	EH-N24-PCX
EAN	8034055106860	8034055106815	8034055106877	8034055102343	8034055106778	8034055106785	8034055106792
Naziv	Držalo pregibno stensko, 60cm, plastificirano	Držalo pregibno stensko, 70cm, plastificirano	Držalo pregibno stensko, 80cm, plastificirano	Držalo pregibno stoječe, 70cm, plastificirano	Držalo ravno stensko, 30cm, plastificirano	Držalo ravno stensko, 45cm, plastificirano	Držalo ravno stensko, 60cm, plastificirano
Cena	89,06	96,38	103,70	284,26	34,16	37,82	42,70

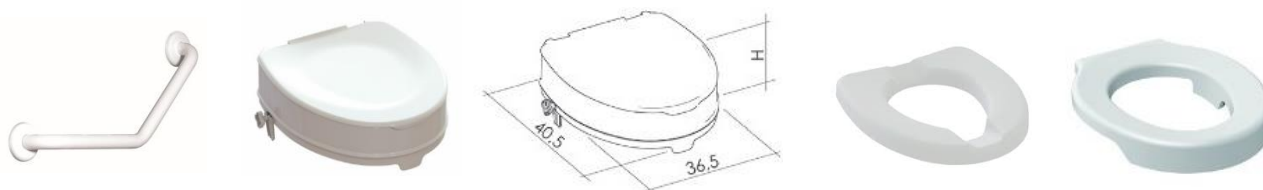

Koda	EH-N1212-PCX	AR-6-L-PP-KD	AR-10-L-PP-KD	PRC-CRTS-E-AX *	PR-STC-E-BX *
EAN	8034055101612	8034055104002	8034055104026		
Naziv	Držalo 45° stensko, 30 x 30cm, plastificirano	WC sedež povišan (6cm) s pokrovom in pritrdilnim mehanizmom	WC sedež povišan (10cm) s pokrovom in pritrdilnim mehanizmom	WC sedež dodatni za povišani sedež AR-10-L-PP-KD	WC varnostni sedež elastičen 39 x 44cm (za vse tipe wc školjk)
Cena	41,00	80,52	84,18	42,58	117,00



Koda	EHP-M6065-PCX	EH-BS-PP-BX *	PR-BS-PP-BX	PR-WS-PP-BX
EAN	8034055105498	8034055105399		8034055100226
Naziv	Ogledalo, ročno nastavljivo, belo, 60 x 65 x 11cm	Sedež za kopalno kad, bel, 67-77 x 30 x 18cm	Sedež za kopalno kad PVC, bel, š42 x g41 x v22cm	Sedež za tuš kabino, stenski, bel, 42 x 51 x 11cm
Cena	230,58	84,18	140,30	181,78



Koda	PR-STA-PP-B	EH-STA-PP-BX	EH-SS-PP-BX	EH-SSA-PP-BX
EAN	8034055100134	8034055105412	8034055105429	8034055105450
Naziv	Stolček za tuš kabino, bel / aluminij, 37cm, teleskopske noge 40-55cm	Stolček za tuš kabino, bel / aluminij, 30,5 x 30,5cm, teleskopske noge 39-54cm	Stolček za tuš kabino, bel / aluminij, 50 x 30cm, teleskopske noge 39-54cm	Stolček za tuš kabino z ročaji, bel / aluminij, 50 x 30cm, teleskopske noge 39-54cm
Cena	108,58	79,30	108,58	145,18

GRELNI SET PRESTIGE LINE S TOUCH SCREEN TERMOSTATOM TVT45 in WI-FI funkcijo



Koda	EAN	Površina (m ²)	Moč(W)	Cena
TVK 410 SET TV TO 170	5901812598165	1m ²	170W	202,91
TVK 415 SET TV TO 170	5901812598172	1,5m ²	255W	220,10
TVK 420 SET TV TO 170	5901812598189	2m ²	340W	244,10
TVK 425 SET TV TO 170	5901812598196	2,5m ²	425W	256,21
TVK 430 SET TV TO 170	5901812598066	3m ²	510W	271,55
TVK 435 SET TV TO 170	5901812598073	3,5m ²	595W	288,71
TVK 440 SET TV TO 170	5901812598745	4m ²	680W	305,88
TVK 450 SET TV TO 170	5901812598752	5m ²	850W	333,35
TVK 460 SET TV TO 170	5901812598769	6m ²	1020W	397,62
TVK 470 SET TV TO 170	5901812598776	7m ²	1190W	433,06
TVK 480 SET TV TO 170	5901812598783	8m ²	1360W	466,05
TVK 490 SET TV TO 170	5901812598790	9m ²	1530W	501,85
TVK 4-10 SET TV TO 170	5901812598813	10m ²	1700W	573,91
TVK 4-12 SET TV TO 170	5901812597700	12m ²	1800W	609,60
TVK 4-15 SET TV TO 170		15m ²	1800W	729,56
TVK 4-16 SET TV TO 170	5901812597731	16m ²	2400W	744,20



ELEKTRIČNI RADIATORJI STYLO

Koda	EAN	Dimenzije (cm)	Moč (W)	Cena
Stylo 500		47 x 41 x 7,5	500	146,00
Stylo 1000		71 x 41 x 7,5	1000	166,01
Stylo 1500		96 x 41 x 7,5	1500	196,01
Stylo 2000		116 x 41 x 7,5	2000	217,00

Konvekcijski električni radiator, montažna globina 11,5cm (montažni set), regulacija moči ogrevanja, možnost timerja s tedensko nastavitvijo, dodatno IR modul in daljinec. Garancija 2 leti.



INFRARDEČI SEVALNI PANELI ECOSUN U+

Koda	Ogrevanje	Dimenzije (mm)	Moč (W)	Cena
ECOSUN 300 U+	do 9m ²	592 x 592 x 30	300	167,80
ECOSUN 600 U+	do 11m ²	1192 x 592 x 30	600	248,79
ECOSUN 700 U+	do 16m ²	1192 x 592 x 30	700	268,80
ECOSUN 850 U+	do 22m ²	1192 x 800 x 30	850	298,80

Montaža strop / stena. Regulacija s klasičnim sobnim termostatom.



KOPALNIŠKI INFRARDEČI SEVALNI PANELI

Koda	Ogrevanje	Dimenzije (cm)	Moč (W)	Cena
ACANTO 110	do 6m ²	101 x 52 x 4,5	450	366,00
HELISEA 110	do 6m	101 x 52 x 4,5	450	463,60

Pritrditev na steno, obračanje 180°. Barva bela ali aluminij, držala siva. Termostatska regulacija s timerjem ogrevanja 15-30-60-120 minut. Zaščita proti vlagi IP24. Teža 5kg.

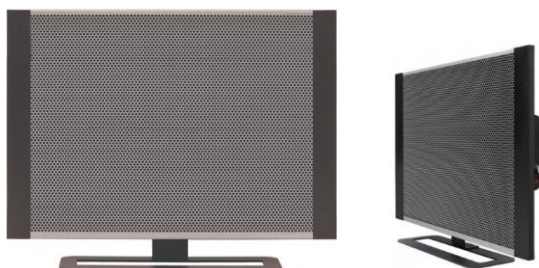

PRENOSNI INFRARDEČI GRELNI PANEL HALOS

Koda	Ogrevanje	Dimenzije (cm)	Moč (W)	Cena
HALOS	do 18m ²	47,5 x 79 x 10	1500	279,38

Možnost stenske montaže. Napetost 230V. Zaščita proti vlagi IP24. Teža 9kg.